

Riva

OWNER'S MANUAL

56 RIVALE *supera*

This manual has been drafted in compliance with standard UNI EN ISO 10240.
Any reprinting, either in whole or in part, without prior written approval by **FERRETTI SPA** is strictly prohibited.
This manual has been issued by **FERRETTI SPA**.



A FERRETTIGROUP BRAND

Registered offices:

Via Irma Bandiera, 62
47841 Cattolica – Rimini – Italy
Tel. +39.0541.839611
Fax +39.0541.839625

Administrative headquarters:

Via Ansaldo, 7
47100 Forlì – Italy
Tel. +39.0543.474411
Fax +39.0543.782410
www.ferrettigroup.com

www.riva-yachts.com
customerservice@riva-yachts.com

1 - FOREWORD

1.1	GENERAL INFORMATION	2
1.1.1	Introduction to the use of the manual.....	2
1.2	MANUAL INTRODUCTION.....	3
1.2.1	Service request procedure - warranty.....	6
1.3	KNOW YOUR RESPONSIBILITY AS OWNER.....	7
1.4	NOTICES	8
1.4.1	Specific safety warnings	9
1.5	CERTIFICATION, CLASSIFICATION AND IDENTIFICATION.....	10
1.5.1	Yacht identification specifications	11
1.6	LOAD-CARRYING CAPACITY.....	12

2 - SAFETY

2.1	SAFETY RULES AND WARNINGS	14
2.1.1	Use-related rules.....	16
2.1.2	Maintenance rules.....	18
2.1.3	Fire prevention rules.....	23
2.1.4	International standards for the prevention of collisions at sea.....	26
2.2	NOTES ON THE ENVIRONMENT.....	27
2.2.1	Regulations for waste disposal	28
2.3	SAFETY EQUIPMENT	29
2.3.1	Arrangement of safety equipment.....	30
2.3.2	Arrangement of fire-fighting equipment.....	32
2.3.3	Self-inflatable life raft	34
2.3.4	Individual life jacket.....	36
2.3.5	Life belt	38
2.3.6	First aid kit.....	39
2.3.7	Signalling rockets.....	40
2.3.8	Emergency boarding system	41
2.3.9	Portable fire extinguishers	43
2.4	MAN OVERBOARD RECOVERY	46
2.5	ATTACHMENT POINTS AND SIDE RAIL	47
2.6	ESCAPE ROUTES.....	48
2.6.1	Abandonment of the yacht.....	51

2.7	FORBIDDEN AREAS	52
2.8	ENGINE ROOM FIRE-FIGHTING SYSTEM.....	55
2.8.1	Fire-fighting system operation.....	59
2.8.2	Maintenance of the engine room fire-fighting system	61
2.8.3	Restoring the fire-fighting system in the engine room.....	62
2.8.4	Garage fire-fighting system.....	63
2.9	ALARM DEVICES	65
2.9.1	Smoke detection unit	66
2.10	ANTENNAS, NAVIGATION LIGHTS AND DAYLIGHT SIGNALS	68
2.10.1	Antennas.....	68
2.10.2	Navigation lights.....	69
2.10.3	Mast daylight signals.....	73
2.11	MANDATORY SAFETY EQUIPMENT	75
2.12	LOCATION OF SAFETY PLATES.....	76
2.13	SCHEDULE.....	77

3 - DESCRIPTION OF THE YACHT

3.1	MAIN DIMENSIONS AND CHARACTERISTIC DATA.....	80
3.2	GENERAL YACHT LAYOUT AND SECTORS.....	83
3.3	MAIN DECK	84
3.4	LOWER DECK.....	88
3.4.1	Galley.....	89
3.4.2	Cabins.....	91
3.4.3	Porthole.....	92
3.4.4	VIP cabin skylight.....	92
3.5	ENGINE ROOM	93

4 - HELM STATION

4.1	YACHT HELM STATION	98
4.1.1	Front section	101
4.1.2	Port section	102
4.1.3	Starboard section.....	103
4.1.4	Starboard side panel.....	104
4.2	INSTRUMENTS	106
4.2.1	Synoptic panel	106

4.2.2	VHF-DSC Radiotelephone.....	107	6.5	BATTERY BREAKER PANEL	193
4.2.3	Throttle.....	110	6.6	BATTERY CHARGER	194
4.2.4	Magnetic compass	112	6.6.1	Checking and maintaining the battery charger	195
4.2.5	Thrusters control joystick	113	6.7	ELECTRIC POWER SUPPLY FROM SHORE.....	197
4.2.6	Multifunction display.....	113	6.8	FUSES	199
4.2.7	Steering wheel	115	6.9	INVERTER (OPTIONAL).....	200
4.2.8	Steering joystick (optional).....	116	6.9.1	Inverter maintenance	202
4.2.9	WATCHIT system (optional).....	120	6.10	GENERATOR.....	203
4.2.10	Back-up control panel	122	6.10.1	Generator control panel	205
			6.10.2	Generator maintenance	206
5 - WATER SYSTEMS			6.11	SACRIFICIAL ANODES	209
5.1	FRESH WATER SYSTEM.....	126	6.11.1	Maintenance of sacrificial anodes.....	210
5.1.1	Cold fresh water system	130	7 - PROPULSION SYSTEMS		
5.1.2	Hot fresh water system	131	7.1	PROPULSION SYSTEMS	216
5.1.3	Watermaker (optional)	132	7.1.1	Start of propulsion engines	217
5.1.4	Maintenance fresh water system	133	7.1.2	Checks after start of propulsion engines.....	220
5.2	GREY WATER SYSTEM.....	137	7.1.3	Stop of engines.....	220
5.3	BLACK WATER SYSTEM.....	141	7.1.4	Engine emergency procedure.....	221
5.3.1	Operation of the toilet.....	146	7.1.5	Propulsion engine maintenance.....	222
5.3.2	Maintenance of black and grey waters draining system	147	7.2	GEARBOX	225
5.4	SCUPPERS SYSTEM.....	150	7.2.1	Gearbox maintenance.....	226
5.5	BILGE SYSTEM.....	152	7.3	SHAFT LINE	228
5.5.1	Main bilge system	152	7.3.1	Propeller shaft and through-hull seal	228
5.5.2	Maintenance on the main bilge system.....	155	7.3.2	Mechanical shaft seal	229
5.5.3	Centralised pump system	157	7.3.3	Shaft line maintenance	231
5.6	SEA WATER SYSTEMS	158	7.4	PROPELLERS	233
5.6.1	Maintenance of sea cocks and strainers.....	162	7.4.1	Maintenance of the propellers.....	233
6 - ELECTRIC SYSTEM			7.5	EXHAUST SYSTEM	236
6.1	ELECTRIC SYSTEM.....	168	7.5.1	Engine exhausts	236
6.1.1	Maintenance of the electric system.....	174	7.5.2	Maintenance of the engine exhausts	238
6.2	ELECTRICAL PANELS	175	7.6	FUEL SYSTEM	239
6.3	GROUND PROTECTION SYSTEM.....	189	7.6.1	Fuel inlet	243
6.4	BATTERY SET	190	7.6.2	Fuel quality.....	244
6.4.1	Checking and maintaining batteries.....	191	7.6.3	Fuel system maintenance	245

7.7	THRUSTER SYSTEM.....	250	11.2	PRECAUTIONS FOR HARSH CLIMATES	301
7.8	OIL CHANGE SYSTEM	252	11.2.1	Cooling system	301
8 - STEERING SYSTEMS			11.2.2	Fuel system.....	302
8.1	STEERING SYSTEM.....	254	11.3	NAVIGATION SET UP PROCEDURES	302
8.2	INTERCEPTORS SYSTEM	256	11.3.1	Weather	304
8.3	GYROSCOPIC STABILIZER	258	11.4	FIRST PERIOD OF USE.....	305
9 - AIR CONDITIONING AND VENTILATION SYSTEM			11.4.1	Engine drive.....	306
9.1	AIR CONDITIONING SYSTEM.....	260	11.5	REFUELLING.....	308
9.1.1	Refrigerating unit control panel.....	264	11.6	WATER SUPPLY.....	309
9.1.2	Fan-coil control panel.....	266	11.7	SHORE CONNECTIONS.....	310
9.1.3	Air conditioning system maintenance	267	11.7.1	Water connections	310
9.2	ENGINE ROOM VENTILATION SYSTEM	269	11.7.2	Electric shore power supply	310
10 - AUXILIARY EQUIPMENT ON BOARD			11.8	MOORING AND UNMOORING	311
10.1	MOORING AND ANCHORING ARRANGEMENTS	272	11.8.1	Leaving the mooring	312
10.1.1	Anchor winch	275	11.8.2	Mooring manoeuvre.....	312
10.1.2	Anchor winch maintenance.....	279	11.8.3	Unattended mooring	314
10.1.3	Mooring winches	280	11.9	OPERATION AND PRECAUTIONS	
10.1.4	Mooring winches maintenance	281		DURING NAVIGATION	315
10.2	GANGWAY SYSTEM.....	282	11.9.1	Operating in shallow water.....	318
10.2.1	Gangway systems maintenance	285	11.10	NAVIGATION IN SPECIAL CONDITIONS	319
10.3	SWIM LADDER SYSTEM.....	286	11.10.1	Navigation with bad weather conditions.....	319
10.3.1	Swim ladder maintenance.....	288	11.10.2	Navigation with one only engine	321
10.4	GARAGE HATCH SYSTEM.....	289	11.11	ENGINE EMERGENCY SUCTION FROM THE BILGE.....	322
10.5	STERN PLATFORM SYSTEM.....	291	11.12	TOWING THE YACHT.....	326
10.6	WINDSCREEN WIPER SYSTEM	294	11.13	YACHT STEERING RULES	328
10.6.1	Maintenance of the windscreen wiper system	295	11.14	ANCHORING OPERATIONS.....	329
10.7	BIMINI	296	11.15	HAULAGE AND LAUNCH.....	330
11 - INFORMATION FOR USE			12 - HULL AND FURNITURE MAINTENANCE		
11.1	GENERAL INFORMATION	300	12.1	GENERAL MAINTENANCE OUTLINES.....	334
			12.2	LONG PERIODS OF YACHT INACTIVITY	336
			12.3	RE-USE OF THE YACHT AFTER A LONG INACTIVITY	339
			12.4	HULL MAINTENANCE	340
			12.4.1	Bottom hull	342

12.5	GENERAL MAINTENANCE	343
12.6	MARBLE MAINTENANCE	355
12.7	MAINTENANCE AND CARE OF VARNISHED WOODEN PARTS.....	357
12.8	SPEED MULTISENSOR MAINTENANCE	360

13 - TROUBLESHOOTING

13.1	GENERAL NOTES	362
13.2	PROPULSION ENGINES	363
13.3	GEAR BOX	367
13.4	GENERATOR.....	370
13.5	BATTERY CHARGER	372
13.6	INVERTER (OPTIONAL).....	374
13.7	UTILITIES	375
13.8	FUEL SYSTEM	376
13.9	WASTE WATER DISCHARGE SYSTEM.....	377
13.10	FRESH WATER SYSTEM.....	378
13.10.1	Watermaker (optional)	379
13.11	BILGE PUMPS.....	380
13.12	STEERING SYSTEM	382
13.13	AIR CONDITIONING SYSTEM.....	385
13.14	GANGWAY	387
13.15	BOW THRUSTER	388

Riva

56 RIVALE *supera*

FOREWORD

CHAPTER 1

1.1 GENERAL INFORMATION

NAME OF THE YACHT _____ **56 RIVALE Super**
 TYPE OF YACHT _____ **OPEN**
 PROJECT CATEGORY _____ **A**



CAUTION

CATEGORY A: This yacht is designed for sailing in conditions where the wind can lower than 10 on the Beaufort scale, the significant wave height is greater than 4m and is largely self-sufficient. Excessive conditions, such as hurricanes are excluded. These conditions can be found in long crossings, for example inter-ocean or near the coast, exposed to wind and waves for several hundred nautical miles.

1.1.1 Introduction to the use of the manual

Prior to operate the yacht and the equipment on board, read the manual carefully, in order to acquire an adequate familiarity with the systems and their operation, so as to avoid hazard to personnel and risks of costly damages.

A great passion for sea and the prestige of this yacht are elements that encourage constant and regular maintenance to ensure long periods of sailing, a long life span and an ensuing improvement in safety.

The maintenance operations described in the manual are simple, but should be performed by authorised and qualified technical staff only, according to standard procedures and in compliance with national and international regulations.

For specific interventions it is advisable to request the service of specialized technicians or contact the RIVA After Sales & Service Department.

1 - FOREWORD

For an easy and quick consulting, the manual is subdivided in the following sections:

- FOREWORD
- SAFETY
- DESCRIPTION OF THE YACHT
- HELM STATION
- WATER SYSTEMS
- ELECTRIC SYSTEM
- PROPULSION SYSTEMS
- YACHT STEERING SYSTEMS
- AIR CONDITIONING AND VENTILATION
- AUXILIARY EQUIPMENT ON BOARD
- INFORMATION FOR USE
- HULL AND FURNITURE MAINTENANCE
- TROUBLESHOOTING



CAUTION

Please keep this manual carefully in a safe, dry and easily accessible place for an easy consultation. When you decide to change the yacht, deliver this manual to the new owner in its integrity.

1.2 MANUAL INTRODUCTION

The documentation provided by RIVA to the Owner consists of two types of documents:

- The “**Owner’s Manual**”, edited by experienced professional staff in compliance with the regulations in force;
- The **Technical Document Collection**, concerning the on-board devices/systems (engines, air conditioning, etc..): it consists in a series of independent manuals, delivered by the relevant Manufacturer and/or Suppliers.

The Owner’s manual is the Main Document and must be read in whole, in any case before considering the documents in the Technical Document Collection.

The associated Technical Documentation Collection makes up the set of the Reference Documents that are required to complete the information provided in the Owner’s Manual.

Since these documents are independent and aimed at giving information on specific single components, it is necessary to refer to them when indicated by the Main Document.



CAUTION

RIVA recommends carefully reading the whole documentation delivered by the Manufacturers of the various components.

For all problems concerning the use and the maintenance of components you can refer directly to the Service Departments listed in the documents delivered by the Manufacturers.

Anyway, in case of need, some little interventions can be carried out by the staff on board, after consulting the operation manual.

This manual has been realized by RIVA in their mother language (Italian) and translated into other languages, to satisfy the customer’s requirements, and has been issued with the purpose of assisting you with the use of your yacht in full safety and with complete satisfaction.

This manual contains a detailed description of the yacht, of the systems and devices installed and practical information about its use and maintenance.

Always use trained and competent persons for maintenance, repair and modifications. The modifications that may affect the safety features of the yacht should be evaluated, carried out and documented by competent people. The manufacturer of the yacht can not be held responsible for changes that are not approved.

We recommend that you carefully read through this manual so as to become familiar with its contents before starting to sail for the first time.

If this is your first yacht, or if this is a type of yacht that you are not familiar with, for your safety and to ensure your maximum satisfaction, make sure you have acquired sufficient experience about how to use and operate the yacht, before “taking the command”.

**CAUTION**

Make sure that the conditions of wind and sea correspond to the design category of your yacht and that you and your crew are capable of manoeuvring the yacht in such conditions.

Even when your yacht is classified accordingly, the conditions of sea and wind corresponding to design categories A, B and C ranging from storm conditions for category A to the conditions of wind and sea strong for the upper limit of category C, exposed to the dangers of a tidal wave or a wind gust. These are therefore dangerous conditions, where only a competent crew, coached and trained on well-maintained yacht can operate satisfactorily.

THIS MANUAL must BE STORED AND WILL ALWAYS BE ON THIS YACHT AT EVERY TRANSFER OF PROPERTY. SANCTIONS ARE ENVISAGED IF THE YACHT IS NOT EQUIPPED WITH THE "OWNER'S MANUAL".

IN CASE YOU LOSE OR DAMAGE THIS MANUAL, RIVA WILL ALWAYS BE ABLE TO SUPPLY YOU WITH A NEW COPY OF IT.

**CAUTION**

RIVA declines all responsibility for any damage to third parties due to discrepancies between the manual and reality.

**CAUTION**

This manual contains pictures of details not representing completely our yacht or with colours not corresponding to your arrangements. This is mainly due to the fact that it is possible to encounter problems during the realization of details' photos, like bed covers and sofas, which are defined only shortly before yacht delivery and therefore when the manual itself has already been issued.

**CAUTION**

In some countries, a license or permit to drive are required or specific regulations are in force. This yacht may be conducted exclusively by authorized personnel to command and to the conduct of pleasure craft in relation to the same class of the yacht.

**CAUTION**

All yachts, regardless of their strength, may undergo serious damage if used improperly. This is not compatible with safe navigation. Always adjust the speed and course of the yacht under the terms of sea.

**CAUTION**

If the yacht is equipped with a life raft, carefully read the operating manual. The yacht should have on board the appropriate safety equipment (life jackets, safety line, etc..) depending on the type of yacht, to the weather conditions, etc.. This equipment is mandatory in some countries. The crew should be familiar with the use of all safety equipment and emergency manoeuvring (man overboard recovery, towing, etc..), sailing schools and clubs regularly organize training sessions.

**CAUTION**

All persons should wear a suitable buoyancy aid (life jacket / personal flotation equipment) when they are on the deck.
Note that, in some countries, it is a legal requirement to always wear a buoyancy aid that complies with the applicable regulations.

1.2.1 Service request procedure - warranty

The extensive RIVA service network is glad to provide you with any information regarding issues not addressed by the manual.

Customers may contact Dealers, Sale Offices, Service Centres or directly:

RIVA AFTER SALES & SERVICE DEPARTMENT

Via Ansaldo 7 - 47100

Forlì - Italy

Tel +39 0543 474445

Fax +39 02 70058589

customer.service@riva-yacht.com

RIVA has carefully selected all main components and accessories installed aboard your yacht, choosing among the most reliable manufacturers who, by offering a wide service network, also guarantee a speedy availability of spare parts.



CAUTION

For all aspects related to the warranty of the yacht, please exclusively refer to what indicated in the sale agreement and in the warranty certificate in which all warranty conditions applicable to the purchased product are specified.



CAUTION

The maintenance operations described in the manual are simple, but should be performed by authorised and qualified technical staff only, according to the standard procedures delivered by the devices Manufacturers and in compliance with national and international regulations. We suggest contacting the RIVA After Sales & Service Department.



CAUTION

RIVA declines all responsibility for damage due to improper preservation and poor maintenance.



CAUTION

RIVA declines all responsibility for the installation and operation of electric, electronic or mechanical equipment improperly installed by third parties in any unauthorised way by the Shipyard.



WARNING

RIVA declines all responsibility concerning tampering carried out by third parties on equipment installed in the Shipyard. Such tampering or unauthorized installations will not only void the warranty, but may cause damage to the yacht and injuries to the people on board.



WARNING

Equipment and devices: engine, winch, extractors and other devices are guaranteed by their manufacturers, who will service them directly through their service points. In case of need, the RIVA After Sales & Service Department will support your requests in order to provide you with a quick service and to guarantee the respect of the applicable rules. Upon yacht purchase, the Owner must send the Warranty Certificates of the relevant Manufacturers, in order to start the warranty period. RIVA will not be liable for undelivered Warranty Certificates.

1.3 KNOW YOUR RESPONSIBILITY AS OWNER

As owners of a yacht, it is your responsibility to be aware of several laws and rules applicable to navigation, operation and equipment of your yacht.

Personal flotation devices and other safety equipment must be approved by the Coast Guard and / or other organizations dealing with rules relating to safety. If approved, an adhesive will indicate on equipment itself.

Member States may impose additional requirements.

It is necessary that you know the rules that relate to your areas of action.

It is the responsibility of the owner and / or operator of the yacht to know the rules of navigation and safety and navigational practices.

Take up time to read the Nautical Rules of Navigation (COLREGS) that are found in the publication of the Coast Guard "Navigation Rules - International and Internal". CG-169 must be on all the length of more than 39 feet boats. Study the techniques of navigation and safety practices to run your yacht and its equipment.

You are the key person in ensuring the safety of your passengers, the crew and the yacht. Take up time to read the chapter on Safety in this manual for important information regarding the safety procedures.

Each yacht owner or operator must be well informed about the yacht and its systems.

Since you are responsible for the operation of your yacht, we provide you with information about these topics.

For every system on board we have planned a detailed description, including diagrams where appropriate, as well as information about the Maintenance and troubleshooting.

A variety of instruction manuals, courses and videos to help you to improve your knowledge of navigation rules, navigation, operation of the yacht, naval electronics operation, Maintenance, etc..

1.4 NOTICES

To highlight particularly significant sections and/or to indicate some important requirements, some symbols have been defined as follows.



CAUTION

It indicates a reminder to apply certain safety measures or to avoid certain unsafe practices that could lead to personal injury or damage to the yacht, to its components or to the environment.



WARNING

It indicates the existence of a possible hazard that may lead to personal injury or death, if proper safety precautions are not taken.



DANGER

It indicates the existence of a serious hazard that could involve a high probability of death or of serious injury if suitable safety precautions are not taken.



ENVIRONMENT

This symbol draws your attention to the possible hazards of environmental pollution.

NOTE

Draws your attention on information and important memos.

MAINTENANCE

This symbol indicates the maintenance schedules on the various on board devices.

1.4.1 Specific safety warnings

They integrate the general safety notice and are aimed at providing specific information about the nature of possible dangers.

Fire hazard:

To indicate a specific fire hazard.



DANGER

The cause of fire breaking is described here.

Electric shock hazard:

To indicate a specific electrocution risk.



DANGER

The cause of electrocution is described here.

Burn hazard:

To indicate a specific burn hazard.



DANGER

The cause of burn is described here.

Forbidden areas:

To forbid the access, the transit or the stay in a dangerous area.



DANGER

This area describes the forbidden area: for forbidden areas are meant dangerous places or the approaching to mechanical moving parts.

1.5 CERTIFICATION, CLASSIFICATION AND IDENTIFICATION

RIVA yachts undergo rigid and accurate tests required by the International Authorities in charge, in order to obtain a CLASSIFICATION CERTIFICATE.

The RIVA 56 RIVALE Super yacht, on which you are about to sail, has obtained the RINA S.p.A. classification (REGISTRO ITALIANO NAVALE) after supervision of the hull lamination, of the reinforcement structures, of the power system and of the safety equipment on board.



CAUTION

Always keep the plate readable, and, if impaired, or tampered with, contact the RIVA After Sales & Service Department.

NOTE

Builder's plate: Part of the information is provided on the manufacturer's plate affixed to the yacht. A full explanation of this information is provided in the relevant sections of this manual.

The significant wave height is the average height of the waves that make up the highest third of the same, which is approximately wave height estimated by an experienced observer. Some waves know no twice this height.

In the figure aside you will find two plates shown in detail: Manufacturer plate and yacht identification code plate.

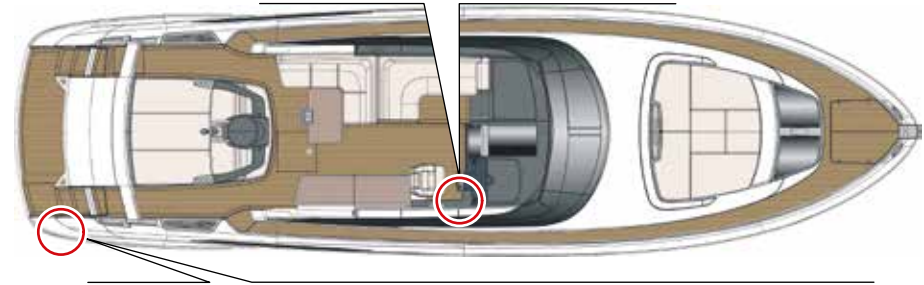
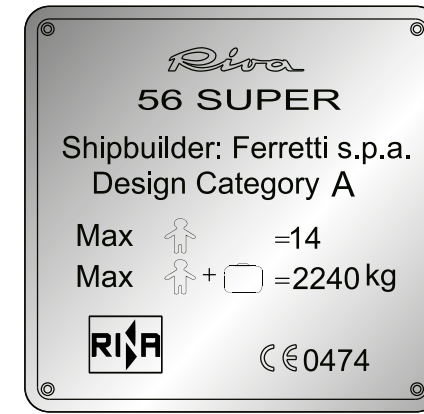

1.5.1 Yacht identification specifications

Manufacturer	FERRETTI S.p.A.
Model	56 RIVALE Super
Type of yacht	OPEN
Identification number WIN (Watercraft Identification Number)	IT-FER_ _ _ _ _
Design category	A (open sea navigation): the wind force can be higher than 8 and the wave height can exceed 4 metres
Certification modules	B+F+A1 (sound emission)
Classification	“EC” conformity according to the standards stated by the Directive 2013/53/EU

1.6 LOAD-CARRYING CAPACITY

Maximum number of persons on board	no. 14
Maximum load-carrying capacity	kg 2240 (4.938 lb) (people + luggage)
Safety equipment (standard)	no. 14
Berths	no. 6
Located in:	<ul style="list-style-type: none"> • no. 2 in bow VIP cabin (double bed). • no. 2 in mid-yacht owner's cabin (double bed). • no. 2 in crew cabin (single beds) (standard) / no. 2 in guest cabin (single beds) (optional).



WARNING

Do not exceed the maximum recommended number of persons. Regardless of the number of person on board, the total weight of persons and equipment must never exceed the maximum recommended load. Always use the seats/seating spaces provided.



CAUTION

Make sure that safety equipment is perfectly efficient and available to each passenger.



CAUTION

The maximum load carrying-capacity includes the weight of all persons on board, all their luggage and personal effects and any other equipment not included in the unladen displacement.



CAUTION

When the yacht is being loaded, never exceed the maximum load carrying capacity. Always take great care when loading the yacht and try to distribute the loads evenly so as to keep the correct trim. Avoid placing heavy loads in the upper part to not reduce the stability.



CAUTION

The maximum load recommended by the manufacturer excludes the mass of the contents of the fixed fuel and water tanks when full. It must exceed the total load that can be added to the displacement to discharge and dry yacht.



CAUTION

The safety equipment provided by the manufacturer are provided for the maximum number of transportable persons. Before sailing, check that the number of safety equipment is always greater than or equal to the number of persons on board.



CAUTION

Changes in the arrangement of the on-board masses, such as the addition of weights at the top, a structure, or the replacement of components with different specifications, can significantly affect the stability, trim, and performance of the yacht. In such cases, contact the RIVA After Sales & Service Department.

Riva

56 RIVALE *supera*

SAFETY

CHAPTER 2

2.1 SAFETY RULES AND WARNINGS

Your yacht has been designed paying the utmost attention to all aspects regarding your safety and the safety of your guests. However, all personnel on board must be instructed and aware about some precautions to be adopted at all times.

For this purpose, it is advisable that all people on board carefully read the guidelines contained in this manual, as well as the signs installed on the yacht and, in particular, all safety notices.

The time spent in reading such instructions will prevent unpleasant accidents.

Remember that you are responsible for your safety and the safety of your passengers, and that you may jeopardize the safety of other boats.

Please make sure you are perfectly aware of the main safety rules:



DANGER

Only the personnel having a regular license or the necessary qualifications can steer this yacht.

Personnel operating the yacht must not be under the influence of alcohol, drugs or narcotics.

- During normal operation or any activities on the yacht, keep passages and escape routes in proper conditions, in order to avoid hazards to people's safety;
- Always perform regular inspections of hull conditions, power system, safety equipment, and systems on a regular basis;
- Always check the fuel level before sailing and compare the tanks' capacity with the engines' consumption and the length and the expected type of cruise;

- Check the expected weather conditions in your sailing area;
- In any case, always act according to common sense.

Safety is also "in the hands" of all those on board, who should be instructed and aware of some precautions to be adopted all times:

- Move carefully around the yacht because its stability may be suddenly affected by the sea waves;
- Persons on board must know the location of life jackets and the location of fire extinguishers (see safety equipment) and of the life raft;
- All passengers must be aware of the risks caused by the fires and the correct way to proceed in the event a fire should occur;
- The engine room must be properly ventilated when the engines are running;
- Everybody on board must be able to release and launch the life belt and the life raft at sea;
- Access to the engine room must be allowed only to authorized personnel, aware of possible dangers like:
 - Moving mechanical parts;
 - Hot parts and components;
 - Circuits with pressurized, hot or irritating fluids;
 - Circuits with flammable fluids;
 - High noise when engines are running;
 - Possibility of inadvertently manoeuvring valves that are important for safe navigation.

Do not tamper with, disconnect, eliminate or by-pass the safety devices installed on your yacht. Periodically check their real efficiency in time to ensure that they can be used in case of need. Failure to meet such requirements may lead to serious risks to the health and safety of passengers.

**WARNING**

Personnel performing any type of operation during the entire lifetime of the yacht must be technically qualified and have proven abilities and experience acquired and recognised in the specific field. The lack of such skills can endanger your safety as well as the safety of people on board and the integrity of the yacht.

Make sure any parts not stored or not secured correctly, cannot move during navigation, hinder the passage, prevent the opening of inner hatches, fall against the people on board, damage or hinder the quick finding of necessary pieces.

**DANGER****Carbon monoxide poisoning**

Adequate ventilation of the yacht is required when the engines are running when navigating at low speeds or in conditions where fumes may re-enter the hull.

**DANGER**

The personnel in charge of the yacht must not be under the influence of alcohol, drugs or narcotics.

**DANGER**

It is absolutely forbidden to remain on the external decks outside protected areas during navigation.

**DANGER**

When the yacht is being loaded, never exceed the maximum load carrying capacity. Always take great care when loading the yacht and try to distribute the loads evenly so as to keep the correct trim. Avoid placing heavy loads in the upper part to not reduce the stability.

**CAUTION**

Always place the necessary attention while navigating, especially in adverse weather conditions or breaking waves.

2.1.1 Use-related rules



DANGER

Carbon monoxide poisoning

Fossil fuel combustion generates a high quantities of carbon monoxide.

This gas is a colourless, odourless and highly toxic.

When the engines and/or the generator are running, the yacht must be properly ventilated, in particular if underway at low speed, or when the exhaust fumes may blow back on board (e.g. when the yacht is shored or anchored or riding the anchor).

Arrange the load evenly so as to keep the correct trim.

Do not overload the yacht especially at bow and aft.

Observe the rules to prevent a sea collision and respect the speed limits; moreover always pay the utmost attention during navigation.



WARNING

The Captain is the only person responsible for driving the yacht.

Prior to departure, the Captain must ensure that the safety equipment required by law is present on board and perfectly working.

The Captain should always meet the requirements and have the specific qualification to steer this yacht as requested by the laws in force in the country of use.

After becoming duly informed as to the operation and controls of the yacht, at first use the Captain should simulate some test manoeuvres, to locate the controls and to be aware of the common reactions of this yacht.



WARNING

Do not use the yacht if the safety equipment is inoperative.

Failure to meet such requirement may cause serious risks to the safety and health of passengers.

The basic operations like start, navigation, anchorage and mooring must be carried out and checked thoroughly; in particular all procedures for navigation set-up should strictly be observed.



WARNING

At high speed, the use of the autopilot is dangerous and not recommended. Always be very careful during navigation even when the autopilot is in use.

All refuelling phases have to be carried out with the necessary precautions to avoid even the smallest spillage of products which could pollute the environment.

When navigating near harbours, beaches and shores, observe the directives issued by local port authorities, particularly as to the speed; high speed can originate wake waves which can jeopardize the safety of the environment and of people.

Before lowering the anchor in free waters, be aware of the kind of sea bottom underneath and near your yacht, to avoid damaging.

**CAUTION**

In the case of using a jet-ski, every passenger must wear a life jacket; the driver must also possess a valid license and follow the rules of the country where it is located.

**CAUTION**

Close portholes, windows and skylights during navigation, especially in poor weather conditions.
Also, make sure that you have closed or locked doors to prevent collisions with objects or people.

**CAUTION**

Any changes in the distribution of the masses on board, such as the addition of weights on top, a structure or the replacement of components with different specifications, can significantly affect the stability, trim and performance of the unit.
In these cases, contact the RIVA After Sales & Service Department.

**CAUTION**

The bilge water is to be reduced to a minimum.
The yacht's stability is compromised with the addition of weights on top.
In the event of rough seas: cabinets and doors must be closed to reduce the risk of flooding.
Crashing waves are a serious danger to stability.

**CAUTION**

Avoid sudden manoeuvres at high speeds.

**CAUTION**

For comfort and safety, reduce speed in the presence of waves.

**CAUTION**

Do not remove or move any weight placed under the floorboards in the deck floor.

2.1.2 Maintenance rules

Keep your yacht in conditions of the highest efficiency, carrying out all scheduled maintenance of the devices on board. A good maintenance will provide the best performance, a longer useful life and a constant respect of the safety requirements.

For the general cleaning of your yacht, only use bio-degradable or environmentally friendly products.



ENVIRONMENT

During navigation, do not release any on-board waste at sea, but keep it and dump it in waste containers ashore.

Remember that it is forbidden to dump oils and fuels into the sea; therefore, it is recommended to clean the engines' bilges by using absorbent materials to be disposed of later on into dedicated containers.

Before carrying out maintenance and adjustment operations on your yacht, activate all safety devices provided and evaluate if it is necessary to inform all persons on board. In particular, place warning signs in the nearby areas and prevent access to any device that, if operated, could cause unexpected hazardous conditions, thus endangering the persons and/or property on board.

Maintenance and adjustment operations must be carried out by authorized personnel who must use all necessary protections according to the procedures provided by the Manufacturer.

All maintenance operations requiring a precise technical knowledge or particular skills must be carried out exclusively by qualified personnel with recognised experience, acquired in the specific field of intervention.

To carry out maintenance in an area that is not easily accessible, or dangerous, take all of the necessary safety measures, according to rules and standards applicable to safety at work.



ENVIRONMENT

Any maintenance operation must be carried out in the strict respect of the surrounding environment. Take all necessary measures to avoid that even one single "oil drop" may be spilled: the protection of our environment starts with this type of attention.

Access to the engine room during navigation must be limited to authorised personnel only, wearing appropriate personal protective equipment.

Inspect the sea water system inlets and outlets as well as the bilge systems. These checks are vital to ensure yacht buoyancy.

Do not perform any maintenance operations or adjustments other than those indicated and/or suggested by the Manufacturer. If necessary, contact the Service Centre for more precise instructions.

Keep all yacht's components clean by following the procedures and using the specific products suggested by the Manufacturer.

Use oils and greases recommended by Manufacturer. This will ensure yacht functionality and the expected safety level.

Do not start any work before ensuring that people on board are not in danger.

If something about the work to be carried out is doubtful, ask someone with knowledge.

Do not draw any conclusions.

Always operate with caution, care, and under safety conditions.

Apart from the regulations stated in this manual, specific warnings are given throughout. This section is meant to provide safety rules for operation and maintenance procedures.

**CAUTION**

This section includes a certain amount of information to maintain the components without dangers. Remember that each time you activate the controls, you are in fact the pilot. You must therefore read and understand the information given before activating the controls.

**CAUTION**

The use of faulty lifting attachments can be the cause of accidents; therefore, check their efficiency. Ensure the compliance of hoisting gears with local norms and their suitability for the job they have to carry out. Also check their soundness according to the work to be carried out. You must therefore read and understand the information given before activating the controls.

**CAUTION**

The use of unsuitable clothing can cause accidents; do not wear loose, flapping clothes which could be easily get caught in the yacht's moving parts. Wear protective clothes suitable for the kind of work to carry out (helmets, safety shoes and protective goggles, overalls). Button cuffs, do not use ties or scarves and do not leave your long hair loose.

**CAUTION**

It is extremely dangerous to operate the yacht controls under the influence of alcohol or drugs. Never take alcohol or drugs before or during work. Do not take medicines that cause dizziness.

**CAUTION**

Be alert and use the greatest caution while working. Take great care to avoid possible dangers.

**CAUTION**

Lifted equipment may fall and hurt you. Do not walk or work under lifted devices not sufficiently and safely supported.

**DANGER**

The engines' moving parts are dangerous; do not open hatches while running the yacht.

**CAUTION**

Yacht entrance. Always face the yacht to enter it and use the handles and the steps. Make sure that steps, handles and rubber soled shoes are clean and dry. It is advised to remove the shoes. Do not jump down from the yacht; do not use the yacht controls as handholds; use the handles.

**CAUTION**

Activating the **throttle** from outside the helm station can cause serious accidents even fatal ones: controls must only be operated from the helm station.

**CAUTION**

Metallic chips from working with metallic parts can cause injury: always wear safety goggles and use a soft mallet or punch.

**CAUTION**

Insufficient **information** may cause accidents. If two or more persons are working simultaneously in the same area, make sure that each one of them is aware of the operation carried out by the others. Before starting the engine, move the other persons from the risky areas (rotary blades and engine belt, tools and movements, engine inner and rear parts). Failure to comply with these precautions may cause serious injury, and even death.

**DANGER**

Do not approach unprotected flames to the yacht. Do not smoke during refuelling or while working on the engine. Carry out refuelling with the engine shut off. Failure to comply with these precautions can cause accidents and injuries.

**CAUTION**

A frozen **battery** may blow up if used or charged; do not start a yacht with a frozen battery. To prevent the battery from freezing always keep it completely charged.

**DANGER**

The **battery** releases explosive gas: do not allow sparks or flames to come close to the battery and never smoke near it. If the battery is used or charged in a closed area, check for good ventilation. Do not check the battery charge by short-circuiting the terminals with metal tools: use a density gauge or a voltmeter.

**CAUTION**

Do not remove the oil tank **filling plug** when the engine is on, because the hydraulic system under pressure may cause injury. Stop the engine before releasing pressure.

**CAUTION**

The spilling of hydraulic oil under **pressure** may cause injuries: before disconnecting or connecting the hoses, stop the engine and operate the controls to release the residual pressure. Prevent the engine from starting when the hoses are disconnected.

**CAUTION**

If damaged, the **hydraulic hoses** may cause death, carry out appropriate periodical checks to check for the presence of:

- Damaged fittings;
- Wear of outer coatings as consequence of rubbing;
- Swelling on outer coatings;
- Bent or squashed hoses;
- Fittings not properly located.

**CAUTION**

Oil is poisonous: do not swallow. The engine oil contains dangerous polluting agents which can generate skin tumours. Handle oil as little as possible and protect your skin with creams and gloves. Any skin that comes into contact with oil must be washed carefully with warm water and soap: do not use petrol, fuel or oil.

**CAUTION**

Hydraulic oil spraying at high pressure penetrates the skin: do not check for oil leaks with your fingers or allow your face to become too close to them. Use a cardboard blank to verify the possible presence of hydraulic oil. If oil penetrates the skin, ask immediately for a doctor for the relevant treatment.

**CAUTION**

Clean the cylinders of the **interceptors** periodically, to remove possible dirt build up, which can jeopardize their efficiency. To reduce the risk of corrosion, pull back the rods each time you leave or you harbour the yacht.

**CAUTION**

The **cleaning** of metallic parts with unsuitable solvents may cause corrosion; use detergents and solvents of the prescribed type only.

**CAUTION**

Seals and O-rings fitted incorrectly, or damaged or worn out may cause leaks or accidents; replace them immediately except when otherwise prescribed. Do not use trichlorethane or solvent near O-rings and seals.

**DANGER**

Hot coolant. When the engine temperature is high, the cooling system is under pressure and the hot fluid can spill over when you remove the radiator plug.

Therefore, before removing it, wait until the system has cooled down, then turn the plug up to the first notch and release the system's pressure.

**CAUTION**

During the restoring operations of metallic or non metallic components, wear **safety glasses**. Move away from the area or protect possible flammable materials, which could catch fire from sparks.

2.1.3 Fire prevention rules



DANGER

On all yachts, fire is a major danger.
All fire prevention measures must be followed scrupulously.

Before steering a yacht, the Captain must be perfectly aware of the following fire prevention measures.

This yacht must always be equipped with portable fire extinguishers positioned as illustrated in the chapter “Arrangement of fire-fighting equipment”.

The yacht’s Owner and the Captain are directly responsible for:

- Having fire extinguishers and fire-fighting equipment overhauled as scheduled on their labels, and having them replaced, as required by the rules in force, with similar or equivalent or higher capacity ones;
- Inform crew members and guests on the yacht about the location and methods of use of fire extinguishers and fire extinguishing systems and emergency exits;
- Ensuring that fire extinguishers are also available in the passengers’ cabins.



CAUTION

The engine room is equipped with a gas fire-fighting system.



WARNING

NEVER:

- Obstruct passageways and the escape routes;
- Hinder access to safety devices, such as fuel valves, electrical switches, etc..;
- Obstruct access to fire extinguishers stowed inside the lockers;
- Leave the yacht unattended, when burners or heat generating equipment are on;
- Use naked flames;
- Modify electric or fuel supply systems, without consulting RIVA beforehand;
- Smoke near or when handling flammable materials;
- Stow highly flammable materials (such as fuel, thinners, etc..) in proximity to heat sources, such as engines, galley, etc..;
- Stow flammable material in the engine room. Non-flammable materials may be stowed only if properly rigged, so they do not accidentally come into contact with rotating engine parts, or obstruct access to the engine room.

Keep the bilge clean and check it frequently for any oil or fuel leaks.

**CAUTION**

In case fire breaks out in proximity to electrical equipment, do not use water, but use the manual dry-powder fire extinguishers only. After using the extinguishers, leave and ventilate the area immediately before re-approaching it, in order to prevent asphyxia and physical harm. Clean out any fire extinguishing powder out very carefully.

In addition to these requirements, RIVA recommends the following:

- Avoid smoking lower deck, especially in the engine room.
- Avoid dropping liquids in the bilge and keep it clean, especially the engine room bilge. In case of fuel leaks from the engines or from the generator, operate as follows:
 - Stop all engines immediately;
 - Locate the leak cause and, if possible, repair it after closure of supply valves;
 - Dry and clean the bilge before restarting the engines, without draining at sea or in the harbour;
 - Do not stow flammable items in proximity to heat sources, like engines, burners, halogen lights, etc.;
 - Should the yacht leak, try to remedy with plugs and/or rags, if possible, from outside;
 - In case a system of the yacht breaks, close all hull valves, locate and repair the leak if possible. Remember to reopen all hull valves not involved.

**CAUTION**

The Captain of a pleasure yacht must be perfectly aware of the basic fire-fighting techniques and how to use the extinguishers.

In case of fire, follow the procedures described below:

- Keep calm and do not spread panic among the passengers;
- Stop the yacht, and close the sea cocks and the drains;
- Set the battery breaker to "OFF";
- Close the air intakes in the engine room;
- Locate the fire and its origin;
- Avoid breathing smoke;
- Extinguish the fire, by following standard fire extinguishing techniques.

**DANGER**

In the event of the yacht sinking, if possible, close the fuel and sewage valves.

Regular and correct maintenance of the systems and prudent behaviour of all passengers are indispensable measures for preventing any risk of fire.

Over 90% of the probabilities of fighting a fire successfully, depends on the ability to prevent and avoid any condition that may help a fire to spread.

The small remaining percentage depends on the crew's reaction ability, and most of all, their rapidity to enter into action.

Nearly all fires, if detected early, can be extinguished easily.

For these reasons, it is necessary to carry out preventive surveys on a regular basis and identify all possible fire sources, and in particular:

- Check the proper operation of all main equipment/systems;
- Visit all compartments and in particular the engine room frequently;
- If a system does not work correctly, identify the failure and take the appropriate corrective actions;
- Operate all systems and equipment as specified.

If a fire is detected, identify and remove the cause, if possible, (e.g. in case of a short-circuit, cut-off the electrical system), extinguish the fire promptly and be vigilant to make sure that the fire does not break out again.



CAUTION

The ability to operate the fire extinguishers properly can ensure the success of the operation.

It is vital that the fire fighting operations are performed by people competent in this type of emergencies.

It is in any case necessary to be aware of the minimum fire-prevention and fire-fighting rules; the first defence is to prevent fires before they start spreading.



WARNING

EXPLOSION HAZARD

Any lithium battery powered device on board must be recharged only in open air areas, connected to a suitable charging system. Also please refer to the device dedicated Use and Maintenance Manual.

The following table contains the classification of the fire types:

Comparison between fire classes

American	Europe/Australia/Asia	Fuel/Heat source
Class A	Class A	Ordinary fuels
Class B	Class B	Flammable liquids
	Class C	Flammable gases
Class C	Class E	Electric appliances
Class D	Class D	Combustible metals
Class K	Class F	Cooking oil or fat

It is very important to use the correct extinguishing agent according to each fire class; normally, water can be used only for class A fires, together with chemical extinguishing agents (portable or fixed devices).

Each yacht owner/operator/master must be well informed and proficient regarding the measures to be adopted in the event of a fire and the applicable fire-extinguishing methods.



DANGER

Regularly check the charge of the fire extinguishers on board.

2.1.4 International standards for the prevention of collisions at sea

The pneumatic whistle (horn) installed on board the yacht adequately meets the requirements of the regulations against collisions at sea (Colreg 1972). Below is an excerpt from the “Rules for the prevention of collisions at sea”.

- **Application** (Rule No. 1): These Regulations apply to all ships on the high seas and in all communicating waters accessible to maritime navigation.
- **Responsibility** (Regulation No. 2): Nothing in these rules shall relieve a ship, the Owner or the crew itself of the consequences of any negligence in the application of the rules.
- **Definitions** (Rule No. 32):
 - “Short sound” means a sound lasting approximately one second;
 - “Prolonged sound” means a sound lasting from four to six seconds.
- **Warning and operating signals (Rule No. 34):**
 - a short sound “I’m going to starboard”;
 - two short sounds “I’m going to the left”;
 - three short sounds “I go back with the machines”;
 - two long sounds and a short one “I intend to pass you on the straight side”;
 - two long sounds and two short “I’m going to overtake you on the left side”;
 - one long, one short, one long and one short sound “is fine for overtaking”;
 - five short sounds “I have doubts about the manoeuvre”;
 - a prolonged sound “ship approaching a channel elbow”;;
 - a prolonged sound ‘ship responding to previous signal’.

- **Signs in conditions of reduced visibility (Rule No. 35 and No. 37):**
 - a prolonged sound at intervals of two minutes ‘ship propelled by mechanical means in a speedboat’;
 - — two prolonged sounds at two-second intervals, repeated every two minutes, “ship propelled mechanically under way, with machinery stationary and without rudder”;
 - — — one prolonged and two short beeps at two-minute intervals “ship steering rough or having difficulty manoeuvring or towing”;
 - — — — one prolonged and three short sounds at two-minute intervals ‘last towed yacht sounding in response to the tugboat’;
 - — — a short, long and short sound ‘ship at anchor’ means its position as approaching ship with risk of collision;
 - — — — — five seconds of continuous sound at one-minute intervals “yacht at anchor indicating its position”;
 - — — three short sounds in rapid succession “signalling a stranded ship”;
 - — — — four short sounds “pilot ship in service”;
 - a continuous sound “danger and need for help”.

2.2 NOTES ON THE ENVIRONMENT

Environmental pollution is caused by three kinds of polluting agents:

- Water polluters;
- Air polluters;
- Soil polluters.

Non oily and black waters (containing only human organic waste) can be discharged into the open sea. In harbour areas they must be collected into suitable containers and afterwards discharged either while sailing into open sea or by means of special drainage systems fastened to the shore or wheel-conveyed.

Soil pollution is caused by discharging waste at shore.

International rules for pleasure yachts essentially prescribe the following:

- During navigation it is forbidden to discharge any non biodegradable product, either of food or commercial origin, into the open sea.
- In the harbour, normal waste is considered as urban waste that must be hermetically sealed in plastic bags and thrown into waste dumpsters.
- Special waste must be disposed of into suitable containers or, if these are not available, it must be delivered to local waste disposing areas, in compliance with the rules in force, issued by the local Port Authority.

- The following waste is considered special waste:
 - Water and oily mixtures (e.g.: Bilge water);
 - Oils (fuel, additives and lubricants);
 - Poisonous chemical substances (like battery acids, paints, thinners and the relevant containers);
 - Spray cans containing C.F.C. gas;
 - Batteries;
 - Spent flares;
 - Expired pharmaceutical products;
 - Products containing lead or asbestos;
 - Etc..
- Fuel and oil leaks.
- Waste discharge and disposal.
- Excessive noise.
- Wake / wake from board.
- Exhaust fumes.
- Paints, detergents and other agents.

Please remember that, according to legislation, until such waste is delivered to suitable disposal areas, you will be considered as possessors and therefore indictable in case of unlawful discharge. Should specific cases be missing in the harbour area, the Authority in charge for the disposal is the Port Authority section "Waste Disposal".

2.2.1 Regulations for waste disposal

The rules governing the discharge of waste (MARPOL 73/78) apply to all yachts with no limits on tonnage and service, therefore also including recreational yachts.

The regulations apply to the entire Mediterranean Sea.

When moored in a harbour, always check that your yacht is not a source of pollution. The environment must be respected and safeguarded, preventing risks for the life of aquatic flora and fauna. It is good practice to leave no trace behind you, to respect laws on safety and environmental protection. Do not discharge bilge waste, oily residues, fuel or other liquids overboard. Dispose of solid waste and old engine oil in the containers provided at mooring points.



WARNING

When sailing, it is always necessary to behave suitably and to respect the safety and the comfort of your guests and of persons on nearby boats. Therefore:

- Avoid excessive noise;
- Do not leave the engines running for long periods without moving off;
- Do not sail at high speed or beyond the permitted limits when leaving or entering harbours, marinas, etc., To prevent causing excessive wash or wave motion.



ENVIRONMENT

It is absolutely prohibited to throw into the sea: plastic materials, synthetic cables, fishing nets, waste bags, floating packaging materials, cordage, paper, rags, glass, metals, bottles, galley utensils and similar.

Non-comminuted or ungrounded foodstuff waste can only be disposed of beyond 12 miles.



CAUTION

It is forbidden to use toilets or holding tanks near the shore or in any prohibited area. Use the facilities of the suction port or marina to empty the holding tank before leaving port.



ENVIRONMENT

Always consider and comply with local and international environmental laws against marine pollution (MARPOL). It is advisable to consider the local environmental laws and to respect the rules of good practice.



CAUTION

Within 12 nautical miles from the coast, it is forbidden to discharge the sewage tank into the sea. Keep the discharge pump deactivated and disable the activation automatism if present.

Although the discharge at sea of a wide range of waste produced on board is permitted at specific distances from the nearest shore, except in special areas, waste should preferably be disposed of at the designated onshore collection facilities.

2.3 SAFETY EQUIPMENT

Everybody on board must know the location and the use of safety equipment, that is: life jackets, life belts, life belts with line for “man overboard”, life rafts, extinguishers and fire extinguishing systems (i.e. in engine room, etc..) and radiotelephone.



CAUTION

The diagram shows the position indicated by the manufacturer for safety equipment; therefore represents a useful guide the placement and number.

To adapt and place the safety equipment in accordance with local, national, and international laws.



CAUTION

The above-mentioned safety systems must comply with existing local and international navigation regulations, and which must be periodically inspected and maintained by qualified technical personnel, prior to the expiry date indicated on the systems.



CAUTION

The Captain is required to inform the crew on the yacht about the safety equipment, whether in case of fire or in case of sinking and listing.



CAUTION

Ensure that safety devices are efficient and available to each passenger.



CAUTION

To sail at a distance of over six miles from the coast, pleasure yachts both with and without EC mark must have a deviation chart officially authorized by Maritime Authorities. To this purpose, the compass installed on board must be compensated by personnel authorized by the Harbour Master who, after completing the operation (compass turns), will issue the chart with residual deviations. These charts do not have an expiry date, and are therefore not renewed when periodic inspections are made for the renewal of the Safety Certificate. It is one of the responsibilities of the captain of the yacht to verify correct compass operation and to update deviation values.





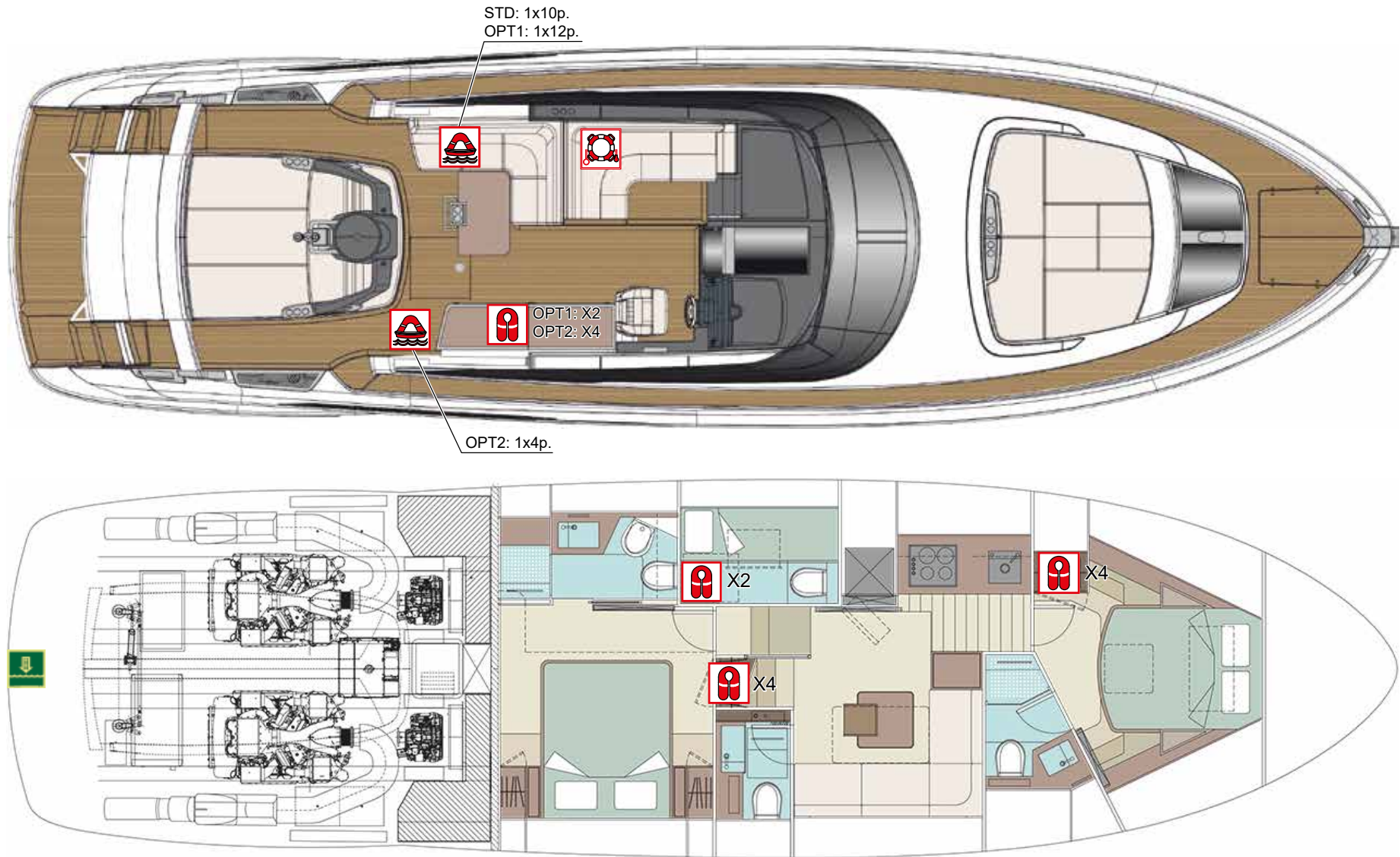

DANGER

Periodically inspect the wear conditions of safety equipment and check servicing or replacement dates, so that the equipment is always in perfect working order.





2.3.1 Arrangement of safety equipment

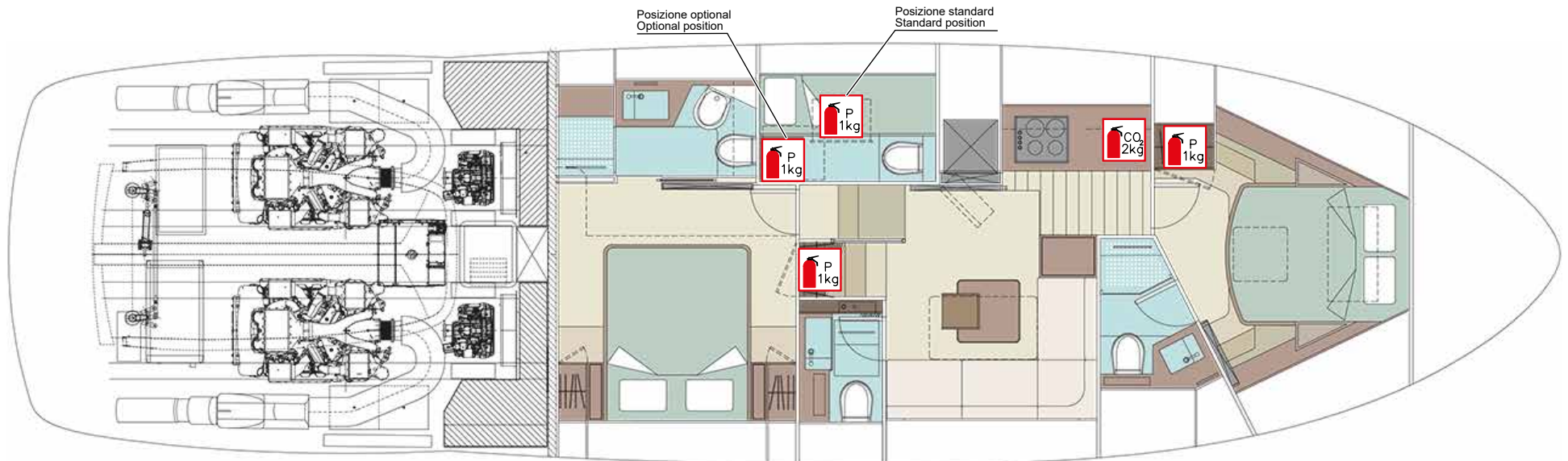
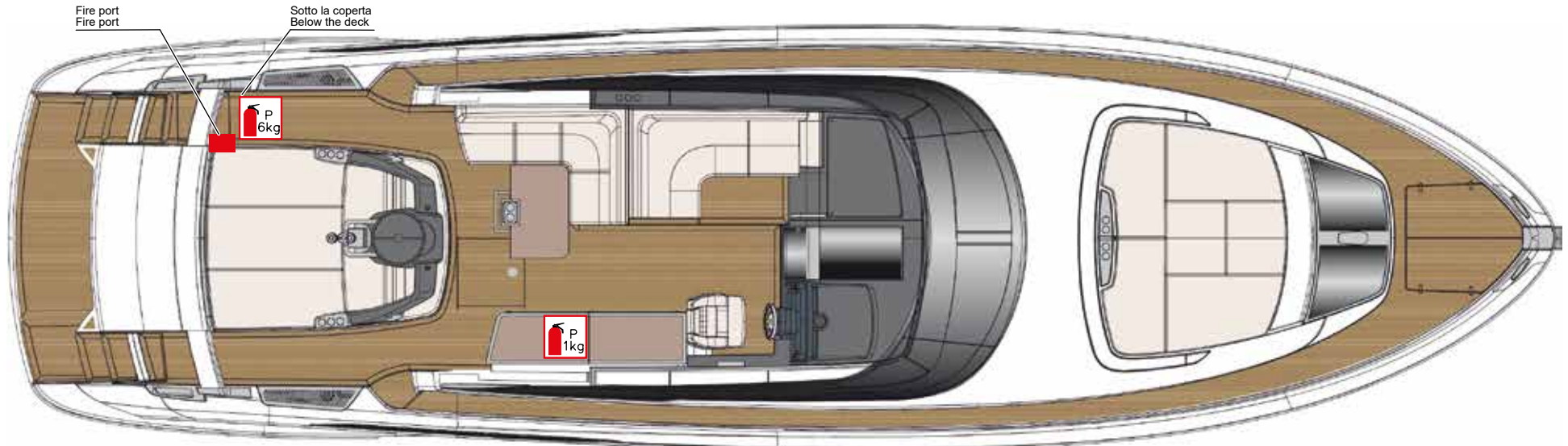

ICONA ICON	DESCRIZIONE DESCRIPTION	Q.tà Q.ty
	Zattere di salvataggio Life rafts	STD: 1x10p. OPT1: 1x12p. OPT2: 1x10p.+1x4p
	Giubbotti di salvataggio con luce e fischietto per adulti Life jackets light and whistle for adult	STD: 10p. OPT1: 12p. OPT2: 14p.
	Salvagente con cima di salvataggio e luce Lifebuoys with lifeline and light	1
	Mezzo risalita a bordo Emergency boarding system	1

2.3.2 Arrangement of fire-fighting equipment



ICONA ICON	DESCRIZIONE DESCRIPTION	Classe Class	Q.tà Q.ty
	Estintore portatile a polvere 1 Kg Portable powder fire extinguisher 1 Kg	A-B-C	4
	Estintore portatile CO ₂ 2 Kg Portable CO ₂ fire extinguisher 2 Kg	A-B-C	1
	Estintore portatile a polvere 6 Kg Portable powder fire extinguisher 6 Kg	A-B-C	1
	Fire port Fire port	/	1

⚠ WARNING

THIS EXTINGUISHER USES CO₂
AS AN EXTINGUISHING MEDIUM
IT SHALL BE USED ONLY TO FIGHT
ELECTRIC OR GALLEY FIRE

TO AVOID ASPHYXIATION
AFTER DISCHARGE
LEAVE THE AREA IMMEDIATELY AND
VENTILATE BEFORE ENTERING

2.3.3 Self-inflatable life raft



WARNING

Before any trip, check that there are no impediments to its immediate use.

In case the use of self-inflatable life rafts becomes necessary, perform the following operations:

- Shut the engines down and wear the life jackets;
- Perform the distress call using the VHF device;
- Uncoil the life line of each raft by 3 to 4 m; secure it tightly to a fixed point of the yacht and launch the self-inflatable life raft into the sea on the lee side;



WARNING

Check that the anchoring line is always well fastened to the yacht.

- Unwind the lifeline completely, then give a strong and decisive pull; the raft will open in a couple of minutes;
- Board by jumping directly from the yacht into the life raft;
- If the distress call has already been made and you have received an answer, prepare for a relatively short wait; then evaluate whether to cut or not the life line. If you did not have the time to make the distress call or you did not receive an answer, prepare for a long wait; in this case, plan for survival, taking the following items, as well as the equipment included in the kit: floating smoke signals and rockets, a knife, drinking water and energy foods that do not cause thirst. Before boarding the raft wear all possible garments, except for shoes that could injure other shipwrecked persons or damage the life raft;
- Embark possible clothes and supplies;

- If somebody falls overboard, help him/her to up into the life raft; throw the life belt with line, if necessary;
- Make sure that everybody is on board, take the knife out of its sheath, and cut the line that ties the life raft to the yacht;
- Move quickly away from the sinking yacht, using the oars;
- When the overpressure valves have stopped hissing, close them by tightening the safety plugs.



CAUTION

The self-inflating life raft has a limited time validity, check its expiry date on the certificate. The raft may be serviced by an accredited body which extends its validity. Sanctions apply for non-compliance with this rule.



DANGER

If the life raft opens upside down, jump into the water and roll it over, by pulling the special rope.

If the life raft does not open after the first pull, repeat the operation two or three times. If the life raft still does not open, jump into the water and, keeping a hand on the container, pull the emergency line strongly. If the life raft still does not open, cut the container open with a knife and operate the opening device directly (by pulling the life line).

Oars are only useful for small manoeuvres.

- The life raft is fitted with stabilisers and a floating anchor, for improving its stability and drift. The stabilisers give stability to the raft. Keep the floating anchor into the water. The anchor prevents excessively rapid drifts.
- When the life raft is towed, weigh the floating anchor on board.

- With very high waves and strong wind there is the risk that the raft may overturn: shift the weight of persons on board towards the side tending to lift.
- If the life raft all does capsize, roll it over and return on board. If the sea is rough, it is advisable to wear the life jackets all the time. If the raft deflates, inflate it again from time to time using the relevant inflating device provided with the raft.
- If air blows out of a hole, use one of the plugs stowed inside the repair kit.
- You can perform minor repairs, by using the glue provided with the kit. Clean the torn area and the repair pad, spread both with the glue. Hold the pad for thirty seconds, pressing from the centre outwards, in order to eliminate any air bubbles.
- Hold down for a little time and inflate again, after one hour.

**DANGER**

All persons on board must know the location of self-inflatable rafts storage and the correct use procedures.

**DANGER**

With very high waves and strong wind there is the risk that the raft may overturn: shift the weight of persons on board towards the side tending to lift.
If the life raft all does capsize, roll it over and return on board.

2.3.4 Individual life jacket

This kind of life jacket assures, by means of a suitable distribution of the floating material, the support of a body with the face out of water, apart from the position taken by the body when diving in the water. These life jackets must be worn correctly and firmly tied by means of strong laces.

It is important to learn, particularly for children, how to float in water with the life jacket.

To avoid energy waste it is necessary to float by keeping legs and arms folded as far as possible and tight to the body to maintain the heat. The individual life jacket is equipped with an orange whistle, fastened to the jacket by means of a safety cord.

The whistle is particularly useful to indicate the wearer's position when the weather conditions do not allow sufficient visibility (bad weather, fog, etc..).

The individual life jacket has to be worn under following circumstances:

- When you navigate through sandbanks or tide reefs;
- At first sign of bad weather;
- When visibility is limited;
- When you navigate with rough sea;
- When you navigate alone;
- At any time with children below 10 years of age.



CAUTION

The yacht must be equipped with a number of individual life jackets equal to the number of persons present on board. All persons boarded must know the location of the life jackets, how to wear them, how to tie them properly to the body, and where the whistle is located.



**DANGER**

If you are to choose a life jacket for a child, take care about for the correct size and that smaller children do not slip out of them once in water. We recommend that all children wear an individual life jacket when they move on the yacht.

**CAUTION**

Do not use the life jackets as pillows.
Practice of their use before you start navigating.
For people with problems may not be suitable.
With waterproof clothing or similar you can not reach the optimal use.
The use of lifejackets does not guarantee total safety and the final rescue of the wearer, but it does support in water for a long period.

**CAUTION****CARING FOR AND INSPECTING THE LIFE JACKETS**

The life jackets must be handled with care so that they are able to save your lives whenever necessary. Check that all the belts, braces and buckles are in good condition and firmly secured on a regular basis. Make sure that all the seams are steadfast and that any welded or glued part adheres perfectly. Check that the reflecting strip, whistle and light are firmly secured and that the light battery has not yet expired.

MAINTENANCE

Wash in warm soapy water after use.
Dry thoroughly.
Store in a dry, ventilated area away from direct sunlight and harmful chemicals.
Check the lifejacket regularly to make sure it is in good working condition.

2.3.5 Life belt

The life belt is equipped with a lifeline of 30 m and with an automatic light buoy.

The life line is not twistable and it is orange in order to be easily seen in water.

At least once a month:

- Check the fastening of the floating line;
- Check the loading condition of the batteries of light buoy;
- At least once every 6 months check the status of the floating line.

**CAUTION**

All crew and passengers must know the location of the life belt.

**CAUTION**

The captain must ensure that the crew and passengers are familiar with the use of the life belt:

- How and where to throw it;
- How to behave in case of “man overboard”.

2.3.6 First aid kit

The first aid box must be kept on board of class A crafts qualified for navigation“ with no limits from the coast”.
The container must be rigid, floating and with watertight closure.



ENVIRONMENT

It is forbidden to discard medicines at sea, even if expired. Treat medicines as special waste and therefore in accordance with the disposal procedures envisaged by the Country in which you are staying/ transiting.

A standard kit is generally divided into four main categories:

- Dressings: Plasters in various sizes, sterile bandages, gauze, medical adhesive tape.
- Disinfectants: Disinfectant wipes, hydrogen peroxide, saline solution.
- Equipment: Round-tipped scissors, tweezers, latex (or nitrile) gloves, thermometer.
- Basic medicines: Anti-inflammatories (paracetamol / ibuprofen), ointments for burns or animal bites.

The main steps to follow if you need to use a first aid kit are:

1. Protect yourself: wear disposable gloves;
2. Assess the damage;
3. Use the right tools;
4. Ask for help.



CAUTION

All passengers must know the first AID kit stowing place.



DANGER

Remember to check the expiry date and **availability** of the products contained in the first aid box at regular intervals.
Remember to store those medicines, which need to be kept in cool places in the fridge.
Inform all passengers of this.
Keep the first aid box in a place free from moisture and away from heat sources, easily accessible, quickly reachable in case of need and far from the reach of children.

2.3.7 Signalling rockets

Pleasure yachts are obligated to carry 4 manual rockets with red light and 4 manual orange smoke signals as required.

Always verify the legislation of the Country in whose waters the yacht is going to navigate.

- The signalling rockets have a limited lifetime; it is therefore necessary to check their expiry date and eventually to replace them.
- The floating smoke signals, visible up to 4 km, have to be used with the daylight, to indicate the correct position.
- The red light rockets, visible up to 10 km, are designed for night use, but they can also be seen during the day.
- Before using the signalling rockets, always wait for the arrival of an air plane or to see persons on the shore or on other crafts.
- Store the signalling rockets away from flammable liquids and from other fuels.
- As the content of the signalling rockets absorbs the moisture, make sure to have them located in a dry and accessible place.
- All persons boarded must know the place of the signalling rockets and the method of use.
- Carefully follow the activation instruction for all signalling rockets.
- Each month, and anyway before each navigation, check that they can be used immediately without obstacles.



DANGER

Keep the signalling rockets away from heat sources, such as flammable liquids or naked flames, and out of the reach of children.



DANGER

Once the signalling rocket has been lit, never direct it towards persons, there is a risk of burns and scalds.



WARNING

The signalling rockets have a limited lifetime, indicated on their containers. Once expired, contact the rockets suppliers which offer a disposal service. Do not light them unless necessary, because they can activate the Emergency Services.

2.3.8 Emergency boarding system

If you are in the water and in the event of an emergency or fall, you can use the boarding aid, consisting of a “ladder” positioned under the stern platform, to get back on board the yacht safely and easily.

To do so, unlock the ladder and pull it up until you can place it into vertical position.



WARNING

After the use of the ladder for climbing on board, place it back to its correct position and lock it.

The boarding aid is a safety device and must be used only in case of emergency.



DANGER

It is the responsibility of the captain, when the yacht is manned but not under way, to ensure the possibility of returning on board.

Emergency boarding system diagram

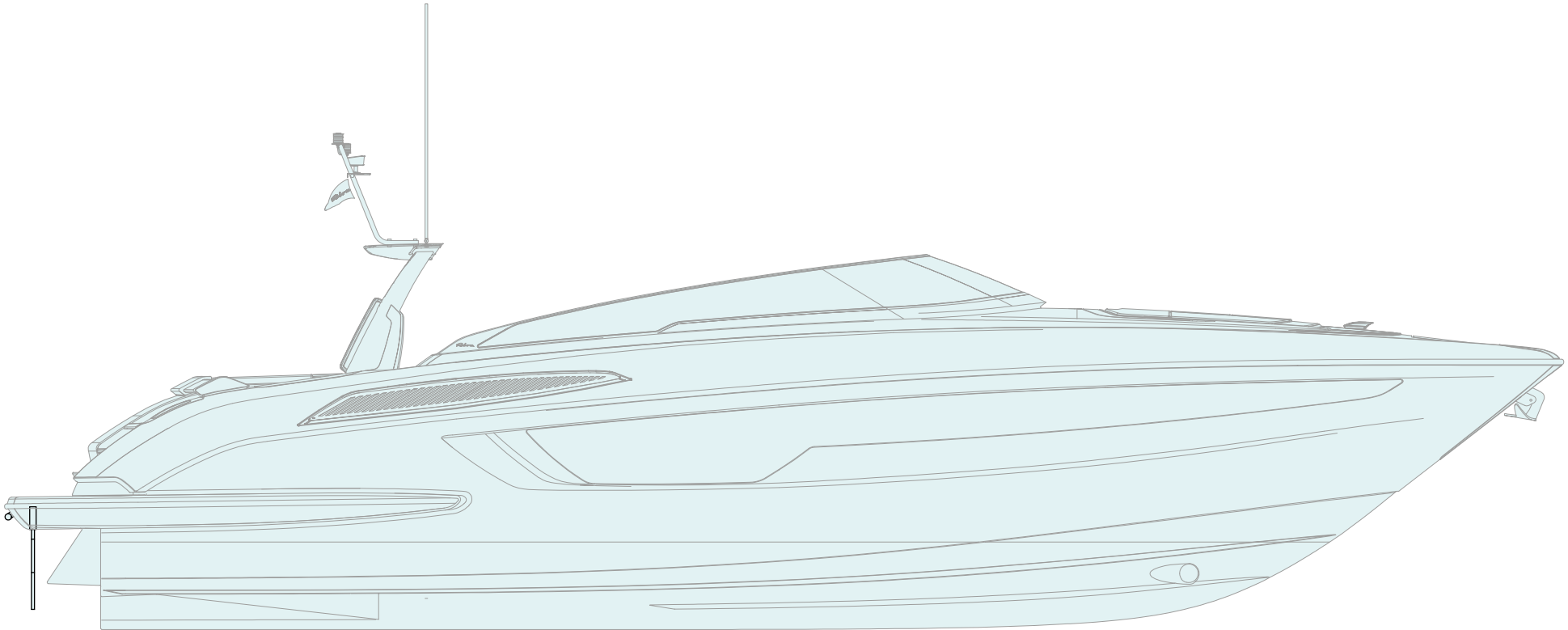

2.3.9 Portable fire extinguishers

In order to supply an easy, ready and quick fire-fighting system on board of your ship, portable fire extinguishers have been set out, designed to be carried manually, and in compliance with the rules in force.

In case a fire breaks out, immediately reach a fire-fighting station where a portable fire extinguisher is located.

The use of a fire extinguisher requires a certain familiarity with it, but some theoretical-practical rules can facilitate its handling:

- Make sure that the safety pin (1) against accidental discharge, has been removed;
- Always direct the extinguisher towards the bottom of the flame;
- Do not stand but try to bow as far as possible;
- Do not hit the fire from above;
- Shift the fan-shaped jet slowly from one side to the other of the flame;
- Act immediately before the temperature becomes too high;
- Always stay windward;
- If the material burnt is wood, paper or tissue, after the fire has been extinguished, pour on water to prevent any further spread of flames;
- Always act dressed, avoiding loose clothing or similar;
- Head the yacht so that the fire is leeward;
- Persons not engaged with the fire fighting must gather windward from the fire area and if necessary, disembark on a rescue device (tender, rubber dinghy, self-inflatable life raft), that must be linked to the yacht with a line, in order also to embark the persons engaged with the fire fighting;
- If the fire is big the operators must abundantly wet their clothing;
- The engines must be shut-off immediately and the fuel must be cut-off;



- Isolated objects in flames must immediately be thrown overboard;
- All openings that can allow air to penetrate through the flames must be closed;
- After using the extinguisher to fight fire in closed spaces, ventilate the space carefully, prior to entry, and remove powder deposits.

**DANGER**

The person in charge of the yacht must make sure that all passengers know the locations and how to operate the fire extinguishers on board correctly.

**WARNING**

We advise regularly checking the charge status (visual check of pressure gauge and weight) and also its overhauling, according to the rules in force in the country whose flag the yacht flies.

**DANGER**

Pay particular attention during the cleaning and cooling operation because the components are still hot and can generate burns or scalds.

The arrangement of the fire extinguishers is indicated in the previous “Arrangement of fire-fighting equipment” diagram.

**CAUTION**

All fire extinguishers should be checked at least every 6 months by qualified staff and in any case, after each navigation. Even after a partial use, the extinguishers should be recharged by authorized personnel.

The extinguisher should be kept in a good condition and the charge indicator, located on the pressure gauge, must always be positioned in the green field.

Keep the extinguishers in a vertical position.

After the use of a dry-chemical fire extinguisher, carefully clean the parts that came in contact with the powder because it is highly corrosive.

NOTE

For further information relevant to the use of the different systems and equipment, see the various manufacturers manuals, delivered separately.

Portable fire-extinguishers maintenance:

Component	Maintenance	Notes and precautions
Portable fire extinguishers	Checks and tests	<p>Check the state of charge of each fire extinguisher at least once every 12 months, and in any case before each journey at sea, by means of the installed pressure gauge. The fire extinguisher is correctly charged when the weight value is as stated on the fire extinguisher's tag, and the charge indicator on the pressure gauge is in the green area.</p> <p>If they are found to be discharged or insufficiently charged, or at least every 10 years, have qualified technicians:</p> <ul style="list-style-type: none"> • Check the condition of the container (cylinder); • Refill the extinguishing medium; • Carry out a hydrostatic test. <p>Have fire extinguishers recharged even after partial use.</p> <div style="border: 1px solid black; padding: 5px; margin-top: 10px;"> <p style="text-align: center;">MAINTENANCE</p> <p>At least every 12 months, and, in any case, before each journey to sea, check the state of charge of the fire extinguisher.</p> <p>At least every 10 years, and in any case before each journey to sea, check the external state of the fire extinguisher.</p> <p>At least every 6 months check the fastening of the fire extinguisher.</p> </div>

2.4 MAN OVERBOARD RECOVERY

Recover a man overboard before possible hypothermia or drowning.

Rescue is a combination of actions: reach the man overboard, establish a contact and bring him/her on board.

- Keep a visual contact with the man overboard.
- Slow down and go towards the man overboard. At night, direct the best light source available towards the man overboard.
- Launch the life belt into the sea, towards the man overboard, and fasten it to the yacht by means of a line. It shall be used as a further reference to the rescuers.
- When approaching the man overboard, stop the yacht or slow down.
- When you are near the man overboard, stop the engines with the gear engaged, in order to avoid that the propellers continue rotating.

Help the man overboard board the yacht.

NOTE

If the victim presents drowning symptoms, give specific assistance.
In case of serious danger, immediately make a distress call.

2.5 ATTACHMENT POINTS AND SIDE RAIL



CAUTION

In the event of adverse weather and sea conditions, use only the attachment points on the starboard walkway to reach the strong points of the bow and stern.

DA RICEVERE IMPIANTO SPECIFICO
R56 RIVALE SUPER

NON RICEVUTO PER R56 RIVALE

2.6 ESCAPE ROUTES

In order to deal with the different emergency situations that could require the abandonment of the yacht (fire, collision with sinking hazard etc..) in the quickest and safest way, the rules in force require an “escape plan” informing about the safest and most secure, as well as the quickest, paths (from any yacht area) for taking shelter and reaching the muster stations, outdoors, from which it will be easier to leave the yacht.



WARNING

During navigation it is necessary to unlock the safety retainer of the bow skylight.



WARNING

Always keep the escape routes, dry, free and accessible.



DANGER

The various yacht's areas have more than one escape route. It is therefore necessary, according to the nature and position of the danger or fire source, to choose the safest and most suitable escape route very carefully.



DANGER



For safety reasons the access door to the engine room must be kept closed at all times and in all situations. Must only be open when crossing.



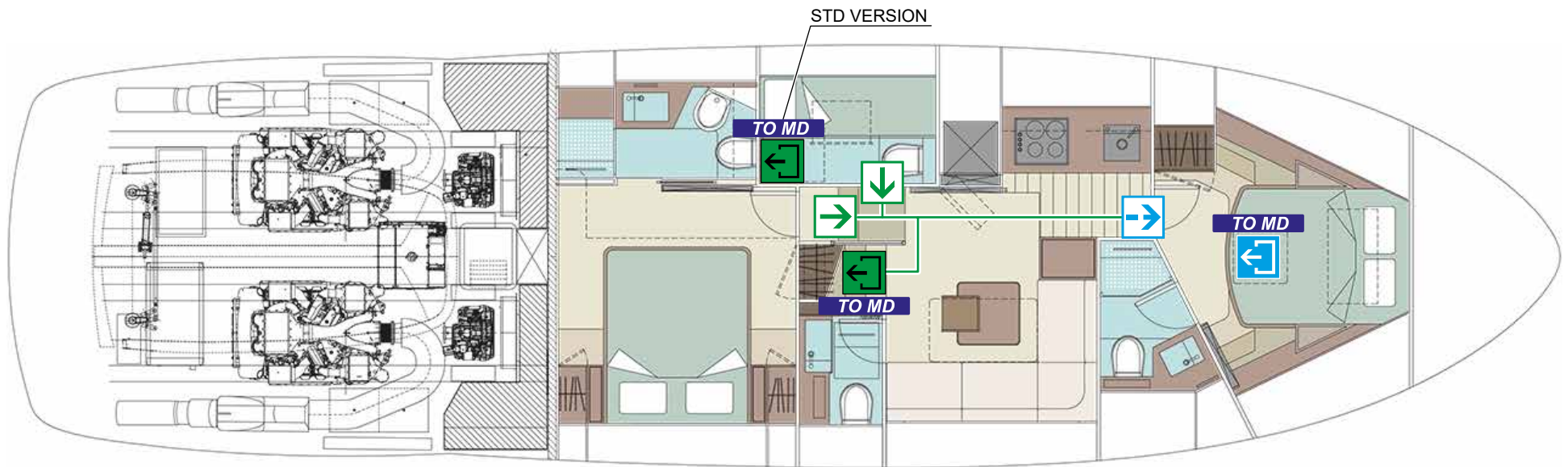
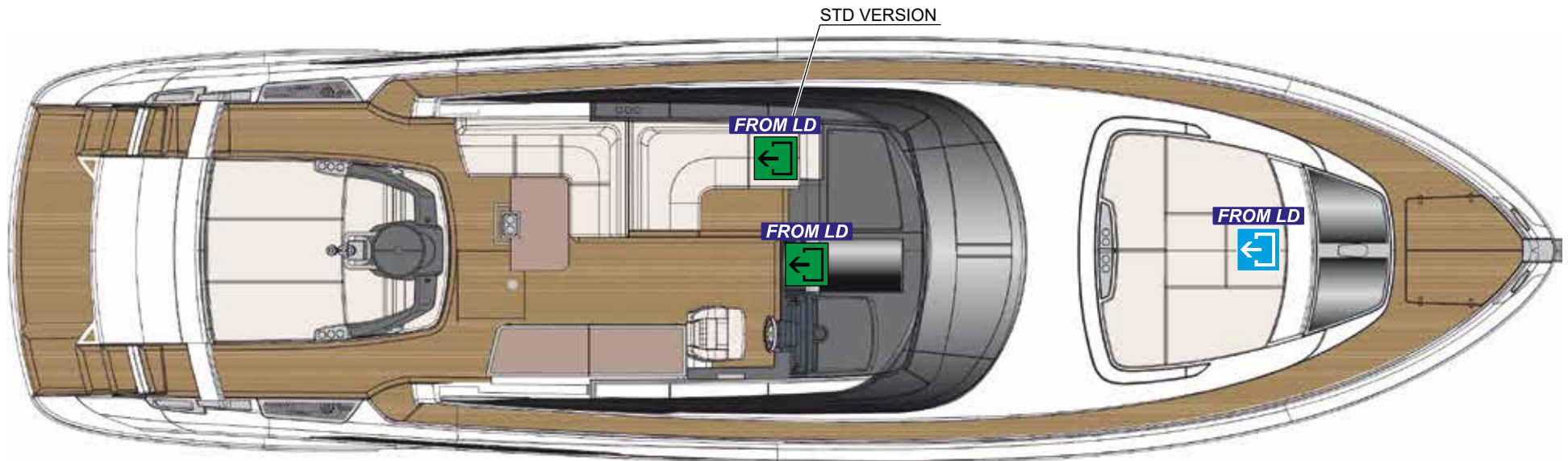

WARNING

Ladders shall be used with care when navigating.



ICONA ICON	DESCRIZIONE DESCRIPTION
	Via di fuga primaria Primary escape route
	Via di fuga secondaria Secondary escape route

ICONA ICON	DESCRIZIONE DESCRIPTION
	Sfuggita principale Primary mean of escape
	Sfuggita secondaria Secondary mean of escape

2.6.1 Abandonment of the yacht

When you must abandon the yacht, swim against the current or windward.
The fuel leaks float in the direction of the current and can catch fire.
When you have taken shelter, count the person present on the yacht and help people in need.
Take advantage of the distress call.

Keep all people gathered in order to facilitate the rescue operation.

2.7 FORBIDDEN AREAS

On board the yacht some areas are “dangerous“, and need plenty of care, and possibly require wearing protective equipment, in order to safeguard the integrity of people on board.



DANGER

During navigation, the risks relating to any hazardous area increase significantly; we recommend scrupulously observing the safety rules indicated in this manual.

The areas are following:

- Engine room: area with a high level of noise, presence of moving components, hazard of burns, hazard of stumbling and falling. The access to the engine room is only allowed to trained and expert crew, prepared for the risks and equipped with proper safety devices, if necessary;
- Stern platform and bow area: outer area not protected by rails against falling into the sea. During navigation the access to this area is forbidden. Accessing and staying in this area is allowed only when the yacht is idle and with the engines shut OFF.

When underway, passengers can stay in the cockpit, preferably remaining seated. When moving, passengers shall use the special handrails installed in the cockpit.

In case of fall overboard, following rescue devices can be used:

- Life buoy;
- Life vests.
- Emergency boarding system.

The easiest way to climb on board is from the stern platform by means of the swim ladder stowed inside the stern structure when not in use.

The following diagram marks out the dangerous areas, with different colours according to the risk level, where utmost care must be paid.



DANGER

Be careful when the deck is slippery. Do not walk on the deck in case of bad weather, when the deck is wet, without shoes with rubber sole or when the yacht is moving.

NOTE

It is responsibility of the Captain to inform all persons on board about dangerous areas when they exist, possible areas temporarily forbidden when maintenance operations are being carried out, as well as about the correct behaviour to be adopted in the above-mentioned areas, also according to weather and sea conditions.



CAUTION

All the areas where there is polished fibreglass are no-step areas.

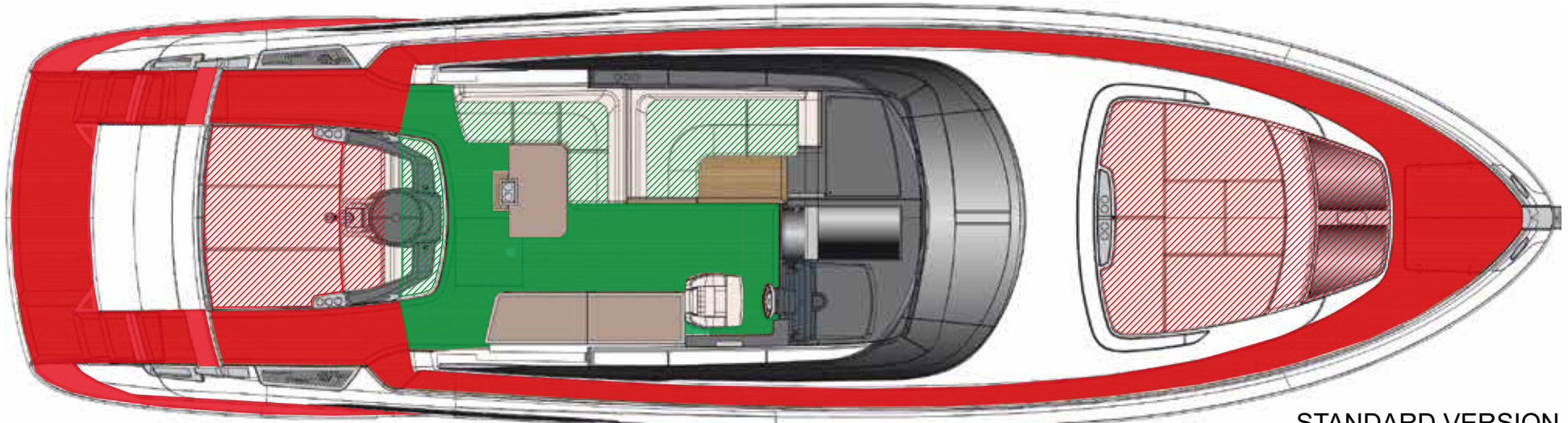

Forbidden areas:

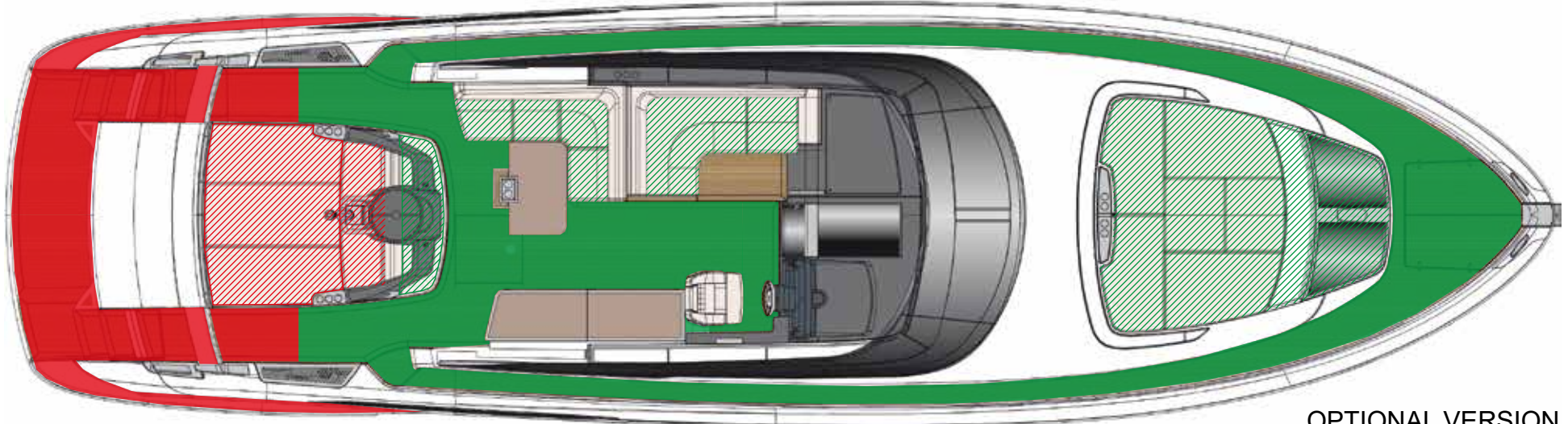

STANDARD VERSION



OPTIONAL VERSION

ICONA ICON	DESCRIZIONE DESCRIPTION
	Ponte di lavoro: Area del ponte utilizzabile per il normale transito o sosta, quando le condizioni della navigazione e del mare lo permettono. Working deck: Deck area for normal transit or stopping when navigation and sea conditions so allow.
	Area interdetta: Area non utilizzabile durante la navigazione. Forbidden areas: Area not usable while at sea.

2.8 ENGINE ROOM FIRE-FIGHTING SYSTEM

The engine room is protected by its own fire-fighting system, with automatic or manual activation, which uses NOVEC as extinguishing agent.

The cylinder is installed in the engine room.

The discharge is activated automatically by a thermal bulb which, as the temperature in the engine room rises, expands until it causes the activation of the fire extinguisher's discharge.

The thermal bulb is fitted on the same cylinder. The extinguisher can also be activated manually; release is controlled by the tie rod located in the starboard cabinet of the cockpit.

The system is equipped with a control unit which in case of discharge, automatically stops the engines, the generator and the extractors in the engine room.

On the starboard cabinet of the cockpit there is a panel for controlling the fire-fighting system described below:

1. **Green light**
Indicates that the extinguisher is full.
2. **Red light**
Indicates that the extinguisher is empty.
3. **SILENCE button**
It turns off the acoustic signal which indicates that the system is operating and that the extinguisher is releasing gas.
4. **DIMMER**
It varies the brightness of the control lights of the CHARGE/OVERRIDE panel.
5. **OVERRIDE button**
 - When this button is pressed, the control unit which, in case of extinguisher discharge, stops the engines, generators and electric extractors, is cut off.
 - In OVERRIDE position the control unit is disabled.



WARNING

The OVERRIDE button must be pressed only when navigating in confined waters or with a collision hazard and to restart the engines after the system's discharge.



CAUTION

The OVERRIDE button must only be used in case of real emergency.



CAUTION

The engine room is equipped with fixed fighting system. To avoid asphyxia, leave the area before the system's discharge. After discharge, ventilate the area before entering.

DA RICEVERE IMPIANTO
NOVEC
PER R56 RIVALE SUPER

DA RICEVERE IMPIANTO
NOVEC
PER R56 RIVALE SUPER

**CAUTION**

Do not delay fire fighting because of a rescue call.

**CAUTION**

To shut the engines down, push the stop buttons.

**CAUTION**

Keep the fire fighting tie rods efficient; service them and check for their operation at regular intervals (as per rules in force).

**CAUTION**

Before setting up for navigation, it is necessary to open the lock and to have the crew access free and the fire-fighting control panel as well. Also check that the safety pin of the cylinders has been removed.

**DANGER**

The fire-fighting system, which only covers the engine room, may not be activated in particular fire conditions and for this reason IT IS ALWAYS MANDATORY TO OPERATE THE SAFETY ROD.

**WARNING**

When operating the fire extinguishing system, disconnect the engine room extractors and close the air intakes. Once the fire is extinguished, ventilate the room for a long time before going inside without activating the extractors.

**CAUTION**

The automatic system is calibrated to detect the fire when they reach 79°C, therefore, if a beginning of a fire is found, it is absolutely necessary to actuate manually the system in order to limit damage to a minimum.

Fire-fighting system control tie rod:

This controls the discharge of the extinguisher in the engine room and disables the electrical system of engines, generator and extractors.

**WARNING**

Do not open the engine room access hatches, until the fire is completely extinguished.

2.8.1 Fire-fighting system operation

The fixed fire-fighting system operates automatically when the temperature in the engine room exceeds 79°C.

The discharge is driven by an automatic system consisting of a thermal bulb installed on the extinguisher cylinder.

When the temperature around the bulb reaches the preset level, causes the extinguisher activates.

The system can also be activated manually. The tie rod for manual activation is located in the starboard cabinet of the cockpit.

By pulling the tie rod, the system stops the engines, the generators and the electric extractors automatically.

A panel located in the starboard cabinet of the cockpit allows you to monitor the extinguisher discharge.

In case of fire in the engine room, operate as follows:

- Shut down both engines and generator, if running, by means of push buttons in the helm position;
- Turn OFF the battery breakers and all magneto-thermal of the AC;
- From the fire-fighting panel, remove pin by slipping it off;
- Pull tie rod safety for extinguisher discharge. The extinguisher can be automatically discharged, but pull the tie rod anyway.



CAUTION

If the fire breaks out underway, perform the distress call "**MAY DAY**"; if the yacht is in the harbour, advise the Port Authority and evacuate all unnecessary personnel.



DANGER

Before activating the fire-fighting system, make sure nobody is inside the engine room. After making sure that the fire is completely extinguished, activate the ventilation system before entering the engine room, and then clean up the deposits of the burning.



DANGER

The automatic fire extinguishing system does not block the possible escape of oil, only suitable tie-rods are able to block this. Always apply the tie rods "FUEL" in the event of a discharge.



WARNING

Make sure that nobody stays in the engine room during the system discharge.



WARNING

It is possible for a fire to reappear following the discharge of a fire-fighting system. If fire spreads again, the passengers on board are in danger. Even the opening of the engine room access hatch can cause through oxygen a new fire spread. If fire spreads out again, to avoid heavy injuries or even death, do not open the hatch or engine room access door until the fire has been completely extinguished.

**WARNING**

Before entering in the engine room after a fire, make sure that this has been completely extinguished. Before entering this room ventilate it by opening the hatches.

**DANGER**

The fire-extinguishing cylinder/s has a safety pin. Check that the above-mentioned pin has actually been removed. If this is not the case, should fire spread out, the cylinder/s would be jammed and would not discharge with consequent possibility of heavy damages to your yacht up to its sinking.

2.8.2 Maintenance of the engine room fire-fighting system

Have the system overhauled by a qualified service centre according to the manufacturer's instructions.

The technician who performs maintenance should attach a tag indicating the date of the check to the system.

Check the discharge indicator before use, to make sure that the fixed fire-fighting system has not been discharged.

The fixed fire-fighting systems must be checked at least once a month and in any case, before each navigation.

- For corrosion.
- To make sure that the access to the controls is not hindered.
- To make sure that the cylinders are firmly sitting.
- To make sure that the pulling cables are not broken, loose, damaged or twisted.
- To make sure that the cable connections are fastened properly.
- To make sure that the discharge nozzles are not clogged.
- To make sure that the system has not discharged.



CAUTION

Accidental discharge of the chemical agents for fire extinguishing during handling or installation may cause serious injuries.

Protect eyes and skin during installation or maintenance of the fire-fighting systems.



CAUTION

Avoid inhaling fumes or long exposure to them.

THE ACCIDENTAL DRAIN DURING USE OR INSTALLATION CAN CAUSE SERIOUS INJURIES.

Never let it drop down. Keep it far from extreme heat.



CAUTION

Read the instruction manual carefully before attempting to install, remove, activate or perform maintenance on this device.



CAUTION

During maintenance operations, pay attention not to break the thermal bulb unintentionally, in order to prevent accidental cylinder releases.



CAUTION

Check that at environment temperature the cylinders pressure gauge is set to correct actuation position indicated by the supplier.

2.8.3 Restoring the fire-fighting system in the engine room

If the fire-fighting system of the engine room has been activated and a fire has been extinguished, it is necessary to restore the essential conditions for navigation, in order to quickly reach the nearest harbour in which to carry out the due checks.

To resume navigation, the ventilation system of the engine room and the fuel system of the propulsion engines must be brought back to normal working condition.



DANGER

Before entering the engine room, ventilate the room properly, to avoid risks due to high temperatures and gases suspended in the air.



DANGER

These operations have to be carried out directly from the engine room; therefore before carrying out any operation, carefully read the safety instructions in this.



DANGER

Resetting the fire-fighting system, with the aim of resuming navigation is a recommended operation only in case the fire source has not caused damage to the yacht's structure or to important devices of the same. In such a case, or should you have any doubt, it is essential, to wait for rescue without resuming navigation.



WARNING

Note that after the fire-fighting system has been reset, the extinguisher will be empty and will no longer be effective in the event of a new fire. Therefore, once back in port, the fire extinguisher must be refilled immediately by authorised personnel.

To allow the propulsion engines to start, manual intervention is required on the engine supply valves on the fuel tank in the crew cabin.

To do this, open the previously closed fuel delivery valves by turning them anticlockwise.

The fuel shut-off valves should not be left in intermediate positions but completely open, when the handle is parallel to the longitudinal axis of the pipe. To make sure that the fire extinguisher is operational, the pressure gauge must be in the green field.



CAUTION

Reinsert the factory-fitted safety pin on the detector/cylinder sensor valve until installation is complete or the inspection has been carried out. Protect your eyes during installation or maintenance.

MAINTENANCE

At least once a month, and in any case, before each navigation, check the charge status of the fire extinguisher.

At least once a month, and anyway before each navigation, check the external condition of the fire extinguisher. At least every 6 months check the fastening of the fire extinguisher.

2.8.4 Garage fire-fighting system

The garage is protected by its own fire protection system.
The system allows to extinguish a fire in the garage without having to enter.

The system is composed of:

1. A 6 kg dry powder fire extinguisher;
2. An opening (fire-port), located inside the left access hatch of the engine room.

To activate the discharge you need to break the glass present in the "FIRE-PORT" protection, insert inside the nozzle of the extinguisher and activate.



DANGER

Chemical elements to put out fires and debris of a discharge system are toxic. To prevent illness, injury or death caused by the inhalation of fumes, make sure that nobody is on the premises during fire extinguisher discharge.



WARNING

Before entering the hatch after a fire, make sure it is completely extinguished. Before entering, ventilate the room by opening the garage.

MAINTENANCE

At least monthly, and before each sea trip, check the state of charge of the extinguisher.
At least monthly, and before each sea trip, check the external condition of the extinguisher.
At least every 6 months to check mounting extinguisher.

Fire-port system diagram

SEZIONE TRASVERSALE AREA TENDER
(Vista poppa)
CROSS-SECTION OF THE TENDER AREA
(Rear view)

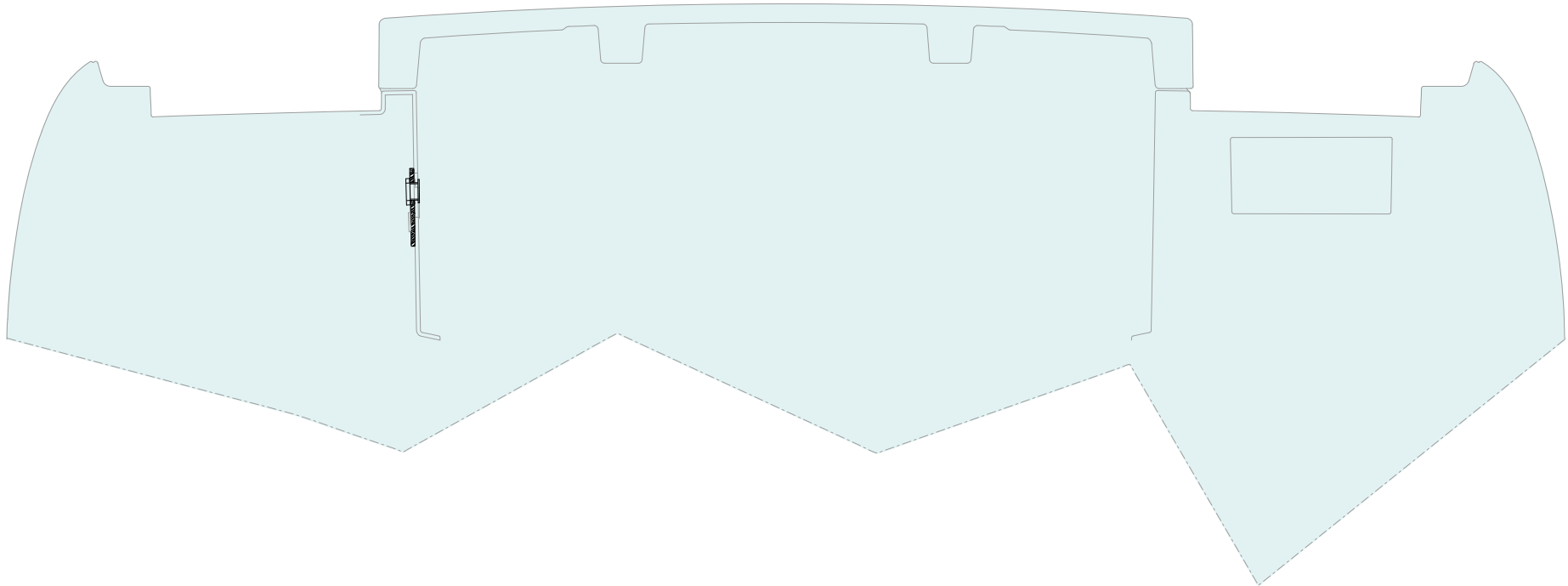

2.9 ALARM DEVICES

Smoke detection control unit

The alarm devices include a smoke detection unit, a flashing signal unit with alarm siren. These devices are activated in the event of smoke detected by sensors positioned in the engine room, and other areas of the yacht. You can monitor the presence of smoke in the yacht also from the panel touch screen present on the helm position.

MAINTENANCE

At least every month carry out an operation test.

Bilge water alarm system

An alarm siren is provided to warn against a high water level in the bilge, operated by floating switches located in the various compartments of the bilge on board.

The alarm is present on the helm position in the monitoring system by means of a warning light/acoustic signal.

MAINTENANCE

At least once a week check the operation of the floating switches and of the siren.

At least once a month clean the floating switches.



CAUTION

To prevent false alarms, make sure that the system is isolated and disabled before performing maintenance and cleaning of the smoke detectors. Once the periodic maintenance of all detectors in food and rehabilitate the system.



CAUTION

For more information about the various devices installed on the yacht, refer to the use and maintenance manuals delivered separately by the Manufacturer.

2.9.1 Smoke detection unit

On board your yacht there is a fire detection unit that can identify anomalous situations and diagnose them. It has a wide range of signals: alarm, pre-alarm, fault, warning, exclusion, tests, monitor. All reports are visible both and on display on both LEDs.

Each detection unit is equipped with its own output of alarm repetition, allowing the alarm to be repeated on the monitoring system.

Both the smoke control unit and the signal light/acoustic alarm unit are supplied with a buffer battery, in this way danger can be detected even without power supply.

If the main 24V power supply of the control unit should fail, the malfunction is indicated visually (alarm warning light) on its control panel.

If both power supplies (main and buffer battery) should fail, the control unit activates the smoke alarm siren.



CAUTION

The control unit has been set and tested by RIVA.
Do not alter the programming controls, read the user manual for a correct operation reset, or better, address the RIVA After Sales & Service Department.



CAUTION

In case the accumulator of the smoke detection unit is discharged, the siren starts automatically.

Use of the smoke control unit and of the signal light/ acoustic alarm unit

The batteries mounted on this unit do not need to be topped up with distilled water.

Keep the terminals on the battery top clean at all times to prevent the battery discharge. Check the battery terminals, they should not be loose and must not have any sign of rust or oxidation.

Apply some Vaseline on the terminals to prevent their corrosion.



ENVIRONMENT

Handle and dispose of batteries according to the rules in force. Use only authorised disposal procedures. In case of doubts, contact the Port Authority.



WARNING

If possible, keep a spare battery on board.

NOTE

For a more detailed description, please refer to the relevant use and maintenance manual.

Fire detection system diagram:

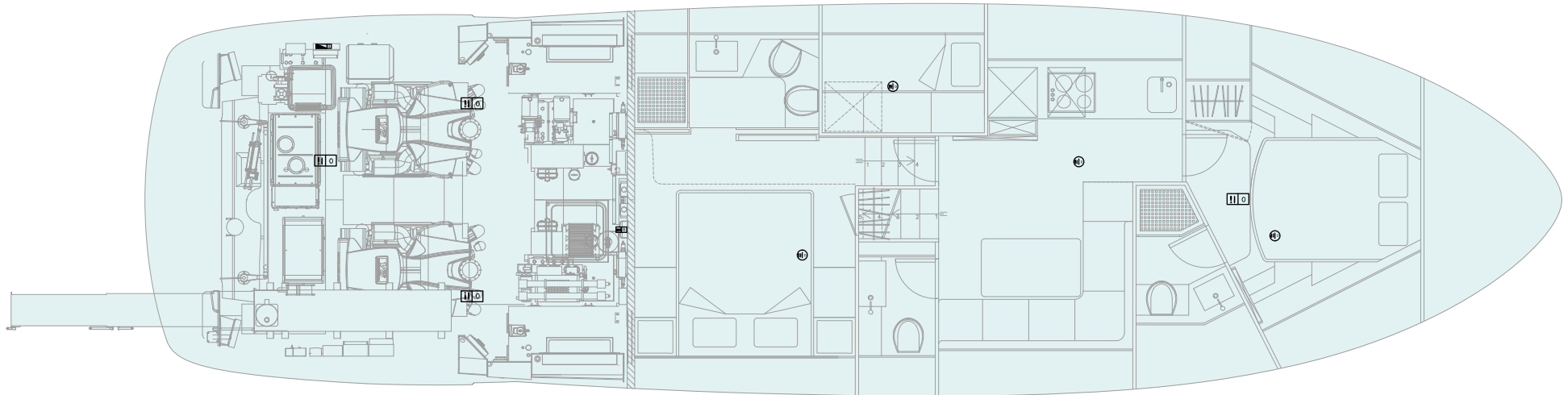

ICONA ICON	DESCRIZIONE DESCRIPTION
	Centralina di rilevamento incendi Fire detection control unit
	Segnalatore acustico Horn
	Rilevatore ottico fumo Optical smoke sensor
	Rilevatore ottico fumo Optical smoke sensor

2.10 ANTENNAS, NAVIGATION LIGHTS AND DAYLIGHT SIGNALS

2.10.1 Antennas



CAUTION

In the presence of TV-SAT (optional), stay more than 2 metres away from the antenna during transmission.

**DA RICEVERE IMPIANTO SPECIFICO
R56 RIVALE SUPER**

NON RICEVUTO PER R56 RIVALE

2.10.2 Navigation lights

The rules relevant to the navigation lights must be observed from sunset to dawn and during this period no other lights must be visible except the lights that cannot be exchanged for those specified in this manual.

Although the lighting system is preset by the Manufacturers, the Owner/Captain has the responsibility for the observance of the local rules.

Please note that the local and international rules relevant to lighting can slightly vary, we suggest therefore to gather information about the local rules of your area.

Night navigation requires more precaution. All rules are applicable but apart from the right of course, it is advisable to slow down and to keep the proper distance from other boats.

It is a good rule to remember that bright lights reduce visibility at night.

Mast head light (white)

Visibility range 225°.

Shown by every engine-driven yacht.

Side lights or navigation lights (red port, green starboard)

Visibility range 112° 30' each.

Shown by any moving yacht and caused by any reason.

Aft light (white)

Said also stern light, visibility range 135°.

Shown by any moving yacht and caused by any reason.

Anchor riding light (white)

Visibility range 360°, can be seen from any point of the horizon.

Seen from every anchored or under navigation yacht, or in specific circumstances.

MAINTENANCE

At least once a week check the operation of the navigation lights.

At least once a week carry out accurate cleaning of glasses and headlights.

At least once every six months check the presence of corrosion in the connections of the navigation light cables.

At least once every six months, tighten the cable connections of the navigation lights.

The use of headlights during the various situations of use of the yacht during night navigation are illustrated below:

- **Navigation:** Masthead lights, side lights and stern lights ON.
- **At anchor:** Anchor lights ON.
- **Adrift:** Two red lights ON (no steering mast installed).
- **Aground:** anchor light and two red lights ON (no steering mast installed).



WARNING

Navigation lights, shapes and sound signals.

Where navigation lights, shapes and sound signals are installed, they must be in conformity with COLREG 1972 (II International Regulations for Preventing Collisions at Sea) or CEVNI (European Code for Inland Waterways). Regulations depending on the case.

**CAUTION**

The positioning of the navigation lights is optimised by adapting the regulatory requirements to the geometry of the boat, providing lights where they are most easily visible.

Non-steering lights (N.U.C. = Not Under Control) and a bell are not included in the on-board equipment. The fitting of lights and sound signals is subject to the approval of the Flag Administration where the boat is registered.

Navigation lights:

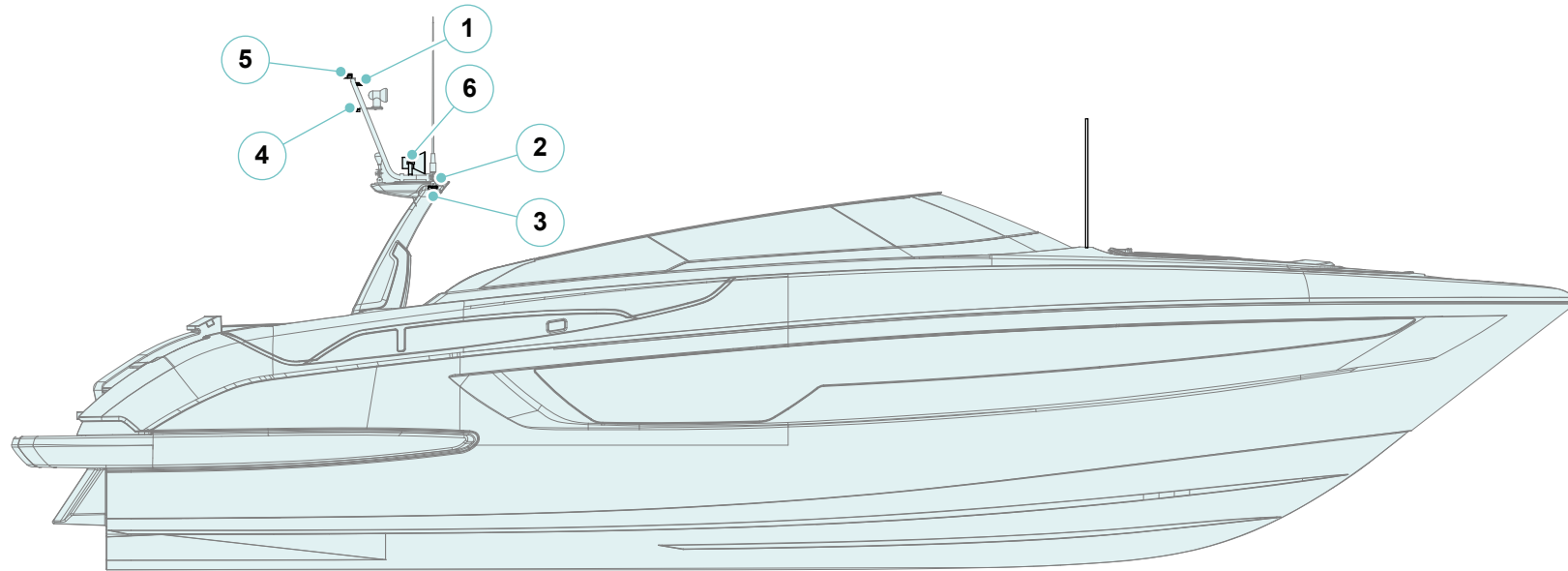

N°	COMPONENTE COMPONENT	COLORE / ANGOLO COLOR / ANGLE	VISIBILITÀ VISIBILITY
1	Fanale di testa d'albero 225° White mast head light 225°	Bianco / 225° White / 225°	3nm
2	Fanale di via destro verde 112.5° Starboard green navigation light 112.5°	Verde / 112,5° Green / 112,5°	2nm
3	Fanale di via sinistro rosso 112.5° Port red navigation light 112.5°	Rosso / 112,5° Red / 112,5°	2nm
4	Fanale di coronamento 135° White stern light 135°	Bianco / 135° White / 135°	2nm
5	Fanale di fonda 360° White anchor light 360°	Bianco / 360° White / 360°	2nm
6	Fischio elettrico Electric whistle		

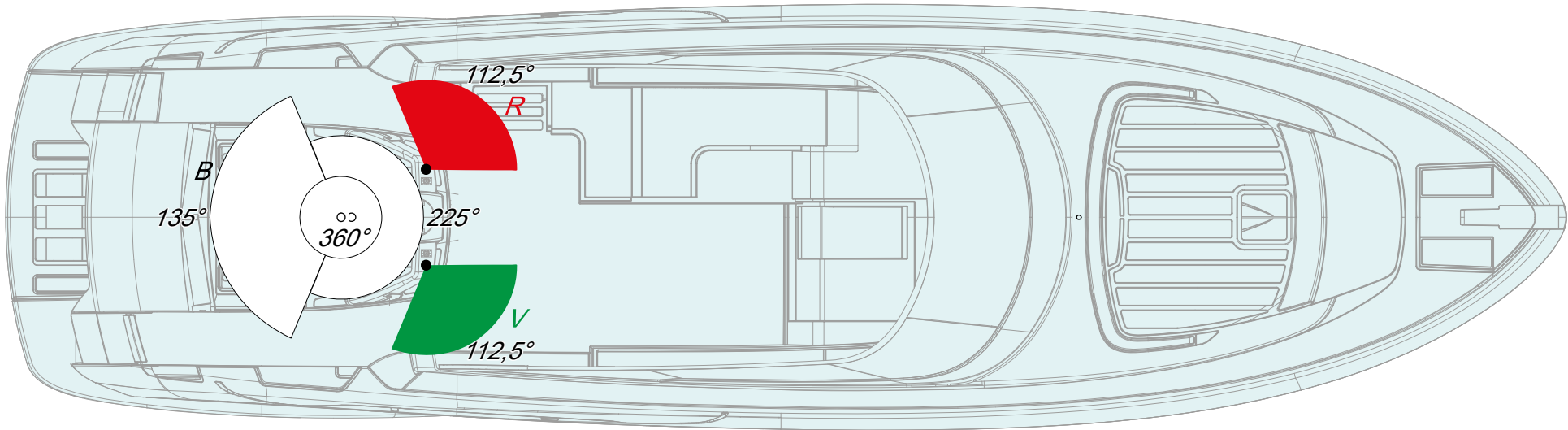

ICONA ICON	DESCRIZIONE DESCRIPTION
■	Rosso Red
■	Bianco White
■	Verde Green

2.10.3 Mast daylight signals

In order to increase the safety of people on board, the manufacturer has provided the installation of a mast for daytime shapes, in accordance with Directive 2013/53/EU.

NOTE

The combined use of shapes, sound signals and navigation lights increases the visibility of the yacht, reducing the risk of collisions.

Daytime signals have the same function as navigation lights but are more visible during the day than navigation lights.

Depending on the situation, appropriate signalling templates shall be used.

Hereunder is a list of the most common ones to adopt after installing the relevant mast:

- Boat at anchor:
- Not Under Command boat:
- Stranded boat:
- Boat with limited manoeuvrability:
- Boat to trailer or towed:

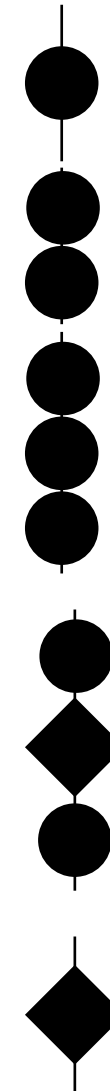

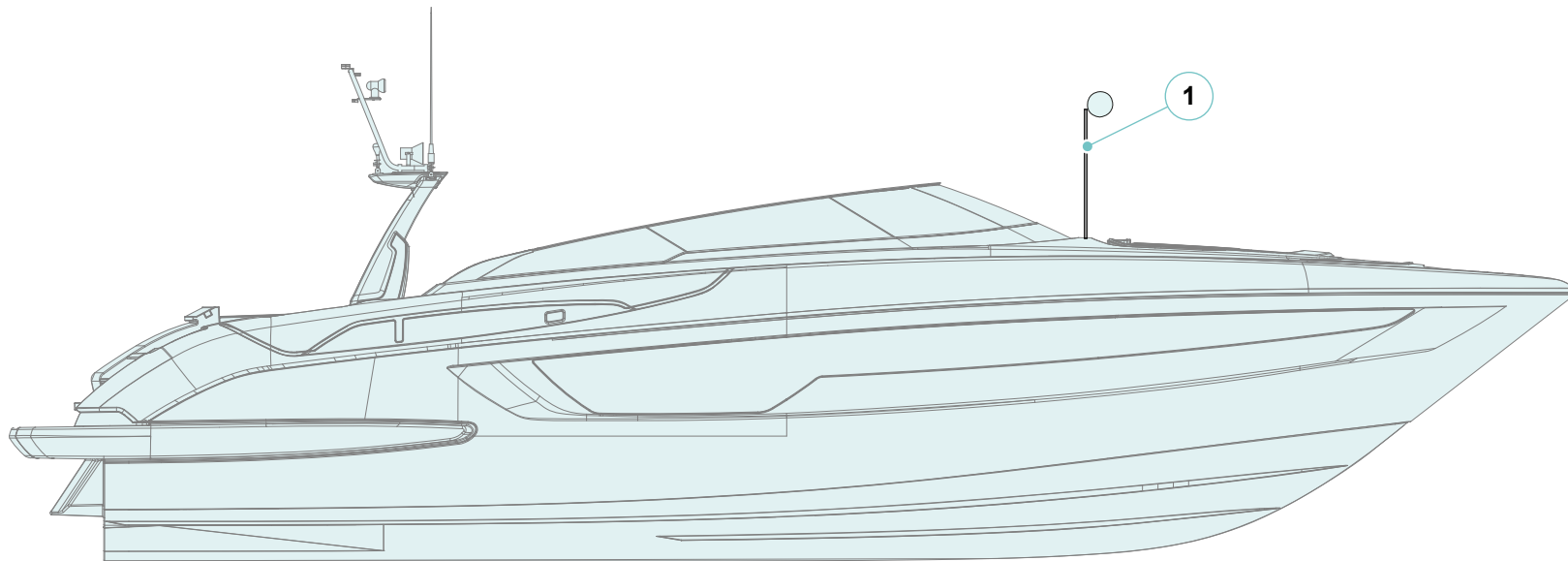
Mast daylight signals:

ICONA ICON	DESCRIZIONE DESCRIPTION
1	Albero segnali diurni Mast daylight signals

2.11 MANDATORY SAFETY EQUIPMENT

In order to ensure the maintenance of the intrinsic safety conditions of the yacht, the Owner must keep the yacht in good operational conditions (as regards to the hull, and the propulsion, electrical and fire-fighting systems), and also to provide for the replacement of any system, rescue and safety equipment showing signs of wear or deficiencies capable of impairing their efficiency.

In addition to the equipment provided by RIVA, the Owner is responsible for providing the yacht with any further system and safety/marine equipment required by the rules in force in the nation where the yacht is used, according to weather and sea conditions and to the distance from safe harbours along the intended course.



DANGER

Rescue equipment must be arranged so as that when it is launched there are no obstacles to free floating and must be equipped with proper fitting allowing for quick release from the yacht when at sea.

The Owner is responsible for equipping the yacht with some of the equipment listed.



WARNING

The above-mentioned safety systems must comply with existing local and international navigation regulations, and must be periodically inspected and maintained by specialized companies and qualified technical personnel, prior to the expiry date indicated on the systems.



CAUTION

Refer to the local Port Authorities for instructions and changes of the Safety Rules in force in the country where you are.

2.12 LOCATION OF SAFETY PLATES

The plates applied on the yacht are used to point out special risks: each plate is located on the part of the yacht which can be a source of risk. Before working with or on this part of the yacht, read the safety warning carefully.

Keep all the plates clean and readable, replace them if missing or damaged.

The fire extinguisher plates are located adjacent to each fire extinguisher.



CAUTION

It is forbidden to remove the plates attached to the yacht.

2.13 SCHEDULE

Minimum rescue facilities and safety equipment to be kept on board of yachts and pleasure yachts with no limit of distance from the shore and with expiry date.

	2028	2029	2030	2031	2032	2033	2034	2035	2036
Self-inflatable life raft (for all persons on board)									
Individual life belt (for each person on board)									
Life jacket with rope (floating type)									
Light buoy									
Smoke buoy									
Red light hand fires									
Red signal rockets with parachute									
Compass and deviation schedules									
Nautical charts									
First aid kit									
RTF inspection									
Property tax									
Insurance									
License (pilot)									
Portable fire extinguishers									
Fixed fire extinguisher in the engine room									
E.p.i.r.b.									

Riva

56 RIVALE *supera*

DESCRIPTION OF THE YACHT

CHAPTER 3

3.1 MAIN DIMENSIONS AND CHARACTERISTIC DATA



Overall length (Loa)	17,27 m	56 ft 8 in
Hull length (Lh)	17,16 m	56 ft 3 in
Waterline length (yacht fully laden)	___ m	__ ft _ in
Anchor + aft platform	0,11 m	0 ft 4 in
Overall height from keel to roll-bar (H)	4,30 m	14 ft 1 in
Depth under propellers (yacht fully laden)	1,60 m	5 ft 3 in
Maximum beam (included saddle tanks)	4,74 m	15 ft 7 in
Displacement unladen	___ ton	___ lb
Displacement laden	___ ton	___ lb

Features		
Hull type		Warped hull with spray rails and aft deadrise 17,8°
Construction material		GRP
Propulsion	Model	STD: MAN V8 - 1000 OPT: MAN V8 - 1200
	Configuration	8 V-cylinders
	Power	STD: 1000 HP (735 kW) OPT: 1200 HP (882 kW)
	rpm	2300
Dry weight	kg (lb)	STD: 1780 kg (3924 lb) OPT: 1941 kg (4280 lb)
Displacement	Litres	16,16 lt
Gear box	Model	ZF 510V
Fuel tank capacity	Litres - Gallons (approximately)	2300 lt - 608 gal
Water tank capacity	Litres - Gallons (approximately)	530 lt - 140 gal
Black water tank capacity	Litres - Gallons (approximately)	170 lt - 45 gal
Grey water tank capacity	Litres - Gallons (approximately)	120 lt - 32 gal
Total weight of liquids (full tanks)	kg	2660 kg - 5.864 lb
On board electric power supply	(V)	230 V single-phase by power generator
	(V)	24 V from batteries
Power generator	Model	19 kW ONAN MDKDV 50 Hz
	Voltage (V)	230 V single-phase
	Frequency (Hz)	50
	Power (kW)	11
Batteries	Engines (no.)	4 x 12V 180 Ah
	Services (no.)	4 x 2V 180 Ah
	Generator (no.)	2 x 12V 180 Ah
Bilge pumps	Engine room (no.)	2
	Owner's cabin (no.)	1

**CAUTION**

RIVA yachts are designed to obtain a correct transversal trim with full optional equipment, as well as spare propellers and shafts.

If the yacht is not provided with full optional and with spare propellers and shafts, some weights are inserted to correct the transversal trim.

The above-mentioned weights can be removed or displaced as soon as the yacht is provided with a new equipment.

NOTE

The technical specifications and the performances indicated are merely indicative, do not constitute an offer with the value of a contract in any way, and are referred to standard models of the yachts built by the Shipyard in the European version.

The only technical indications or descriptions with contract value for the purchaser are those relevant to the specific yacht purchased and contained in the sale documents.

**WARNING**

When loading the yacht, never exceed the maximum recommended load.

Always load the yacht carefully and distribute loads appropriately to maintain design trim (approximately level).

3.2 GENERAL YACHT LAYOUT AND SECTORS

This chapter contains a general description of the yacht and is supported by a set of illustrations thanks to which it is possible to easily locate the main areas and the different devices.

Advice and information on the correct use of the various instruments are also given.

The structure of the yacht has been divided as follows:

1. Main Deck
2. Engine room
3. Lower Deck

The yacht is provided with both electronic and mechanical devices and instruments; some of these are provided with their own user's manuals. The information contained therein are an integral part of this Owner's Manual.

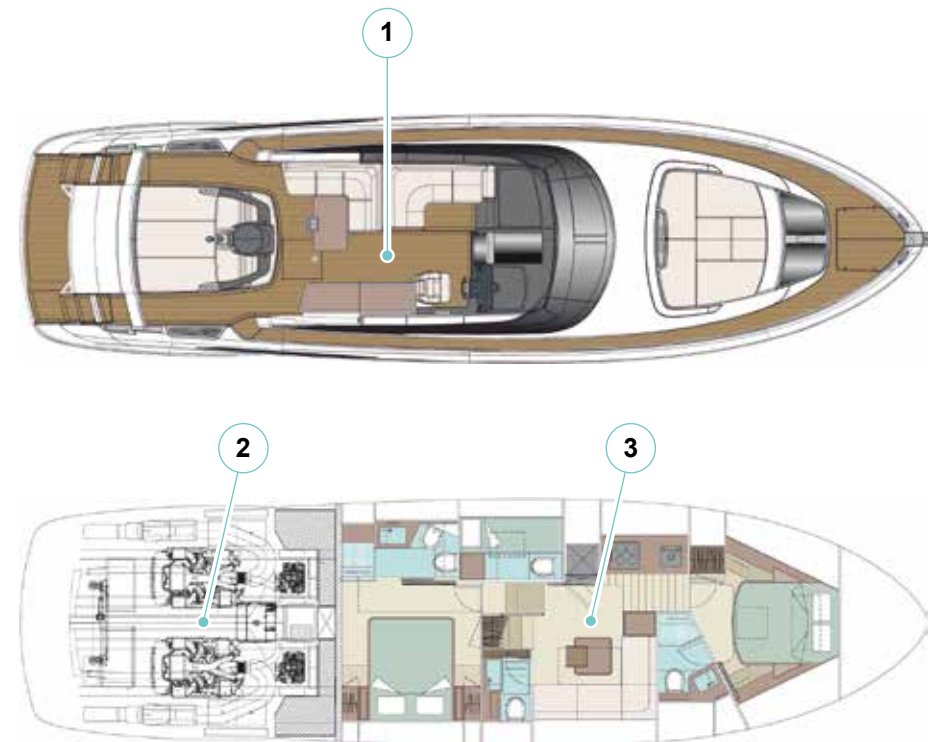

3.3 MAIN DECK

1. Stern platform
2. Shore black water discharge nozzle
3. Garage hatch
4. Port mooring peaks
5. Fuel boarding (DIESEL)
6. Antennas
7. Port side walk-around
8. Cockpit with sofas and table
9. Crew cabin access (Standard Version)
10. Lower deck access companionway
11. Bow sundeck area
12. Chain, anchor winch and fenders peak
13. Bow fairleads and cleats
14. Helm station
15. Freshwater boarding (WATER)
16. Engine room access hatch
17. Stern sundeck area
18. Starboard mooring peaks
19. Gangway
20. Shore electrical socket
21. Freshwater boarding from shore
22. Swim ladder

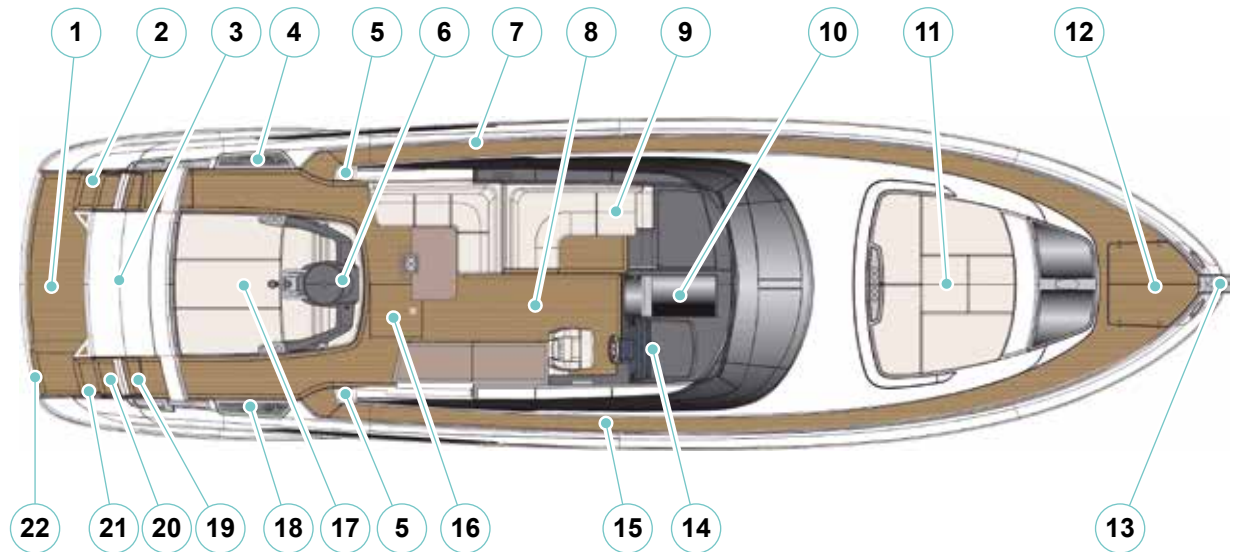

**CAUTION**

The removable awnings and their support poles must always be dismantled and stored in the appropriate places before starting navigation. When the poles are not in use, they should be stored in the appropriate places. The awnings should only be installed when the yacht is at a standstill and the weather conditions are favourable. Do not leave the awnings open in case of heavy rain. Do not leave the awnings installed unattended. Do not let them stagnate the water on the curtain fabric. When not using the awnings keep the holes to engage the poles closed with the appropriate lids.

The access to the yacht from shore is enabled by a gangway located on the starboard side and stowed under the steps.

**CAUTION**

Always use the gangway to board the yacht; any other access system is potentially dangerous.

From the sea level it is instead possible to climb on board by means of the swim ladder located starboard of the stern platform, from which you can reach the deck through the two lateral ladders.

On the aft transom is the garage hatch, the garage can stow inside a tender. The garage hatch can be activated through a switch located in the stern cockpit starboard.

**DANGER**

Never stay on the stern platform during navigation, because this is not equipped with protection rails preventing a possible fall at sea.

**DANGER**

Never start navigation with gate, swim ladder, gangway and garage hatch not correctly retracted or closed.

**DANGER**

The garage hatch must always be closed during navigation, it can stay open only with yacht stationary and with favourable sea weather conditions. Loads stowed inside the garage, in particular a possible tender, must be fastened with the utmost care. During navigation nobody should stay inside the garage.

**DANGER**

As the opening/closing of the garage hatch is performed by an electronic mechanisms, always check that no obstacles or persons are standing nearby before its activation, this operation has to be performed exclusively by skilled crew.

**CAUTION**

Periodically check that groundings are in order. Keep connections dry and protected with anti-corrosion grease.

**CAUTION**

In case a jet-ski is used, each passenger must wear a life jacket; the driver must also have a regular license and keep to the rules of the country where the jet-ski is driven.

**DANGER**

Stop using the on-board handlings if the sea-weather conditions (wind, currents, weather factors) could jeopardize the yacht's stability.

On both sides of the yacht inside the mooring lockers are stowed the aft cleats and the warping winches, useful for shore approaching manoeuvres (see chapter "Auxiliary equipment on board").

**CAUTION**

Do not use the warping winches as permanent mooring points.

Both walk-around, protected by external handrail, allow the access to the bow area.

**WARNING**

When leaning on the outside handrail, be careful so as to prevent any accidental fall at sea.

The bow skylight allows lighting and ventilating the VIP cabin and can also be used as an escape route in case of emergency.

**CAUTION**

At bow, an open skylight is cumbersome and creates an obstacle on the main deck.

**DANGER**

During navigation it is compulsory to unlock the safety retainer of the bow skylight so as to ensure a safe and quick escape.

**DANGER**

Pay particular attention to rotary pieces, keeping your feet, hands, clothing and hairs at due distance.

If you control the anchor winch from the helm station make sure that nobody is near it and that your visual field is free.

The anchoring area is located on the bow of the yacht.
The anchor winch is positioned centrally.

The two side cleats are also positioned on the bow.

Inside the bow peak there are also the remote control for the anchor winch, the hose connection for deck washdown, the solenoid valve controlling the anchor and chain washdown and a fresh water tap.



CAUTION

The protection railing is interrupted at bow for the anchor weighing.



WARNING

During navigation, the yacht's normal movement in the water can cause the slipping or falling of persons with the potential hazard of serious injury or even death. Persons should remain seated in secure locations when the yacht is underway.

Helm station:

The main helm station is situated in the starboard side of the yacht.

The main helm station, allows the use and oversight of the whole yacht steering instrumentation.



DANGER

The personnel operating the yacht during the various activities on board must not be under the influence of alcohol, narcotics or drugs.



CAUTION

For the correct use of the various devices installed in the main helm station, see the relevant instruction manuals.



WARNING

To prevent circumstances that could lead to property damage, injury or death from the improper use of the helm and its controls, the yacht's owner/operator must ensure that inexperienced or unauthorized persons are never permitted to be at the helm station.

Next to the helm station are ladders leading to the main cabins and the galley.

3.4 LOWER DECK

1. Owner's bathroom
2. Crew cabin (Standard Version) / Guest's cabin (Optional Version)
3. Galley
4. VIP cabin
5. VIP bathroom
6. Salon
7. Main deck access ladder
8. Service bathroom
9. Main electrical panel
10. Owner's cabin
11. Engine room

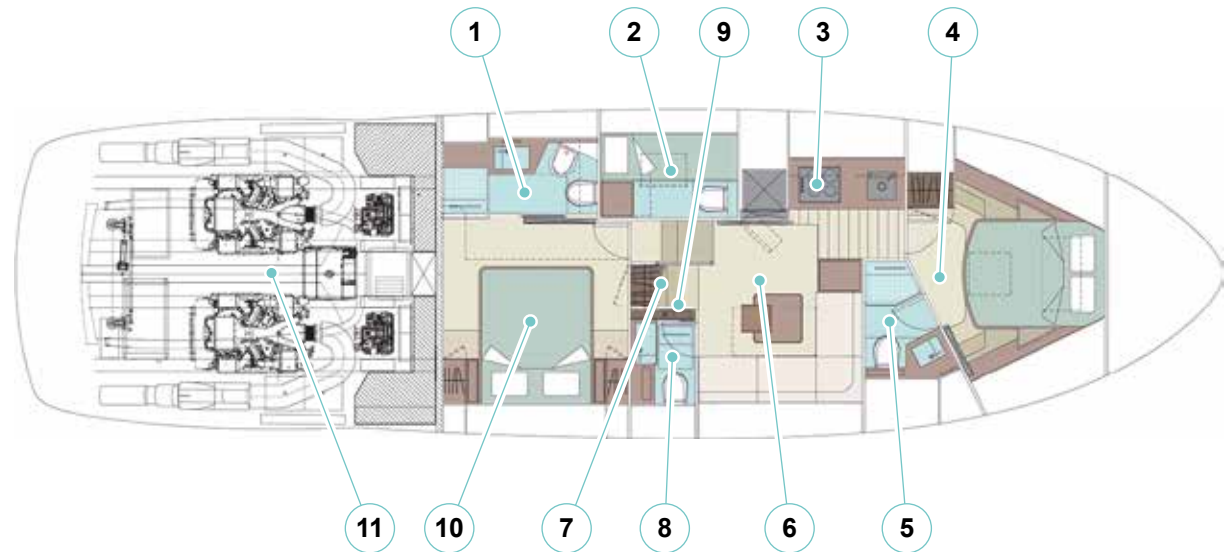

The lower deck consists of two areas, which are accessible from different not-connecting places. The areas are:

- Galley and cabins with bathroom:
 - Owner;
 - Guest's (Optional Version);
 - VIP;
- Engine room;
- Crew Cabin (Standard Version).

**CAUTION**

Before undertaking any navigation, check the closure of the cabs access doors and hatches. You will avoid unpleasant banging and accidental dangers.

3.4.1 Galley

The galley is practical and gathers all the essential household appliances. During navigation it is advisable to properly close all doors. The dishwasher takes water from the cold fresh water system. It is connected with the sink draining and discharges at sea. In the galley, above the electric burners there is a suction hood to eliminate the cooking smokes.

**CAUTION**

Always check the absorption of the household appliances and deactivate them in case they are not used.

**CAUTION**

It is recommended not to fill pots more than 50% with water and not to use pressure cookers.

**CAUTION**

When using the galley, increase the ventilation of the inner rooms as much as possible. Never use the cooking top to heat the room.

**CAUTION**

Do not leave pans unattended when they are on the burner.

**CAUTION**

Do not put liquid food into the oven.

**CAUTION**

Never place metal containers with metal inserts in the oven.

**CAUTION**

In order to eliminate smells, vapour or fumes, it is necessary to turn on the suction hood at cooking start and to keep it on at cooking end for 10-15 minutes.

NOTE

For the procedures and the correct use of the various household devices of the galley, refer to relevant manuals.

**CAUTION**

In case of navigation with rough sea, we recommend not to use the galley.

**CAUTION**

Children are allowed to use the galley only when they are able to use its items correctly and to understand the dangers specified in the special instruction manuals. The help of an adult is required.

**DANGER**

Please remember that the plate, even after use, can still be very hot for a long time, and that it may cause damage to property or scalds.

3.4.2 Cabins

Crew cabin and bathroom (standard):

The crew cabin and bathroom are accessible by means of a passage located in the port stern cockpit. When opening the access hatch you get access to a stair.

The starboard cabin has two berths arranged in a bunk structure.



CAUTION

Close the portholes during navigation or when the yacht is left unattended for a long period.

The cabin is equipped with a self-adjustable air conditioning. For adjustment refer to specific chapter.

Guest's cabin (optional):

The guest cabin are accessible through a door on the port side of the salon.

The starboard cabin has two berths arranged in a bunk structure.

Owner's and VIP cabins with bathroom:

After descending the stairs, illuminated by spotlights, on the left is the access door to the owner's cabin.

The Owner's cabin is placed at mid-yacht, to take advantage of the whole hull width.

The Owner's cabin is also arranged with a roomy wardrobe with mirror and a coat hanging bar.

From the Owner's cabin through a door, you reach the Owner's bathroom equipped with a large shower.



CAUTION

The extremely precious finishing of woods used for the bathrooms floors and for the cockpit tables is the result of an accurate work, water resistant but at the same time delicate and needing accurate maintenance. Such surfaces must therefore be dried after use, after being exposed to rain and or washed, and a regular maintenance must be carried out.

The VIP cabin is the only one having a skylight to be used as an escape route in case of danger.

The skylight opens on the main deck after the sun-deck area.

All cabins are equipped with self-adjusting air conditioning.

3.4.3 Porthole

The porthole consists in a fixed part (frame) and a moving part (window). For opening, it is necessary to unlock the window by turning the handles 90° outwards. Closing is done by means of a thick seal on the porthole frame.



CAUTION

Close the portholes and the skylight when navigating or when the yacht is left unattended for a long period.

The yacht can be equipped with a monitoring system for the porthole closures, with status indicators on the helm station.

3.4.4 VIP cabin skylight

This skylight has the function of a window and of a passage way. The skylight structure is made of stainless steel and unbreakable glass. The skylight is equipped with three locking levers ensuring a perfectly watertight closure. The skylight is equipped with two locks ensuring its opening in complete safety.

MAINTENANCE

At least once a month check the correct operation of the closing system.
At least once every three months check the watertight status.
When necessary, clean the seals or replace them, if required.

3.5 ENGINE ROOM

The engine room can be reached from two different points: through the central hatch in the cockpit or through the bow side hatch.

Before entering this room, switch on the lights.

**DANGER**

You are not allowed to enter the engine room during navigation.

**DANGER**

In the engine room, thermal engines create highly radiated areas which keep temperature high for a long time. Protect yourself and wait until they are cool before entering the engine room.

**CAUTION**

Do not store free-to-move items in the engine room, as they might skid during navigation.

**CAUTION**

Only authorized personnel should have access to the engine room and also be informed about the components operation and about the features of the fire-fighting system.

**DANGER**

For safety reasons the watertight hatches to access the engine room, must be kept closed at all times and under all situation. They must be open only during the passage.

1. Generator
2. Tenderlift hydraulic control unit
3. Generator battery
4. Smoke detector control unit
5. Water heater
6. Port engine
7. Port air extractor
8. Port fuel tank
9. Port air inlet intake
10. Multifunction control unit
11. Engines and services batteries
12. Port engine control panel
13. Engines fuel filter
14. Service inverter
15. Generator fuel filter
16. Bow thrust battery switch
17. Generator battery switch
18. Port engine fuel filter
19. Starboard engine control panel
20. Starboard engine fuel filter
21. Engines and services batteries
22. Watermaker
23. Starboard air inlet intake
24. Starboard fuel tank
25. Starboard air extractor
26. Starboard engine
27. Gangway
28. Engines control unit
29. Switches contactors box
30. Warping box
31. Shore socket unit
32. Garage hatch units box
33. Gangway units box
34. Generator exhaust
35. Generator exhaust separator

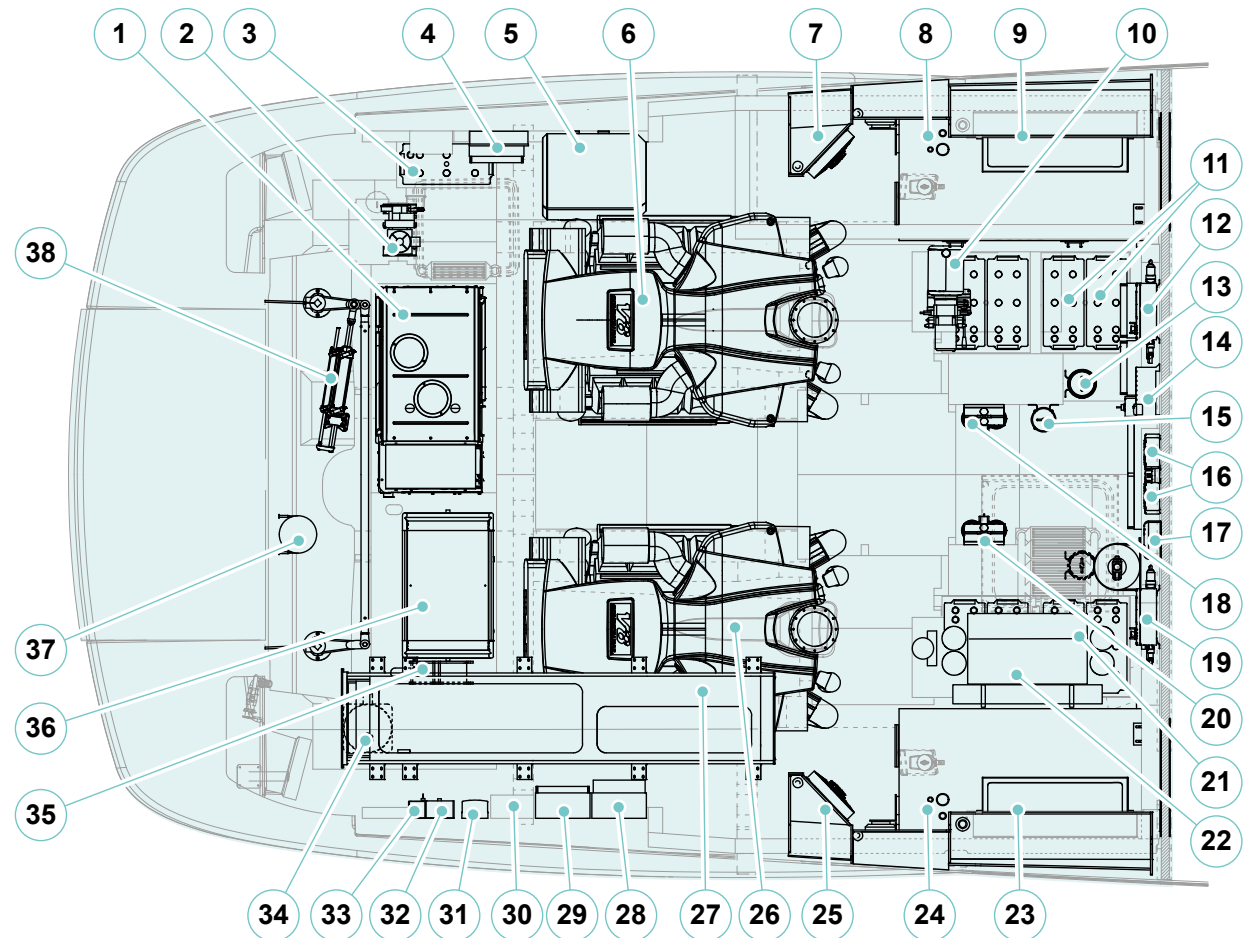

36. Air conditioning unit
37. Air conditioning group expansion tank
38. Steering

- 39. Port engine exhaust
- 40. Steering electro-hydraulic unit
- 41. Services sea water intake
- 42. Generator sea water intake with filter
- 43. Gyroscopic stabilizer sea water intake
- 44. Port engine exhaust muffler
- 45. Port engine exhaust
- 46. Multifunction pump
- 47. Grey water system pump
- 48. Port centralized exhaust
- 49. Black water system pump
- 50. Gyroscopic stabilizer
- 51. Port gearbox
- 52. Black water system exhaust
- 53. Port engine sea water intake
- 54. Fuel collector
- 55. Starboard engine sea water intake
- 56. Starboard gearbox
- 57. Watermaker pump
- 58. Starboard centralized exhaust
- 59. Sea water autoclave pump
- 60. Fresh water autoclave pump
- 61. Starboard engine exhaust
- 62. Starboard engine exhaust muffler
- 63. Air conditioning unit pump
- 64. Starboard engine exhaust
- 65. Services sea water intake
- 66. Stern thrust (optional)
- 67. Gyroscopic stabilizer water intake
- 68. Bilge pump
- 69. Air unit

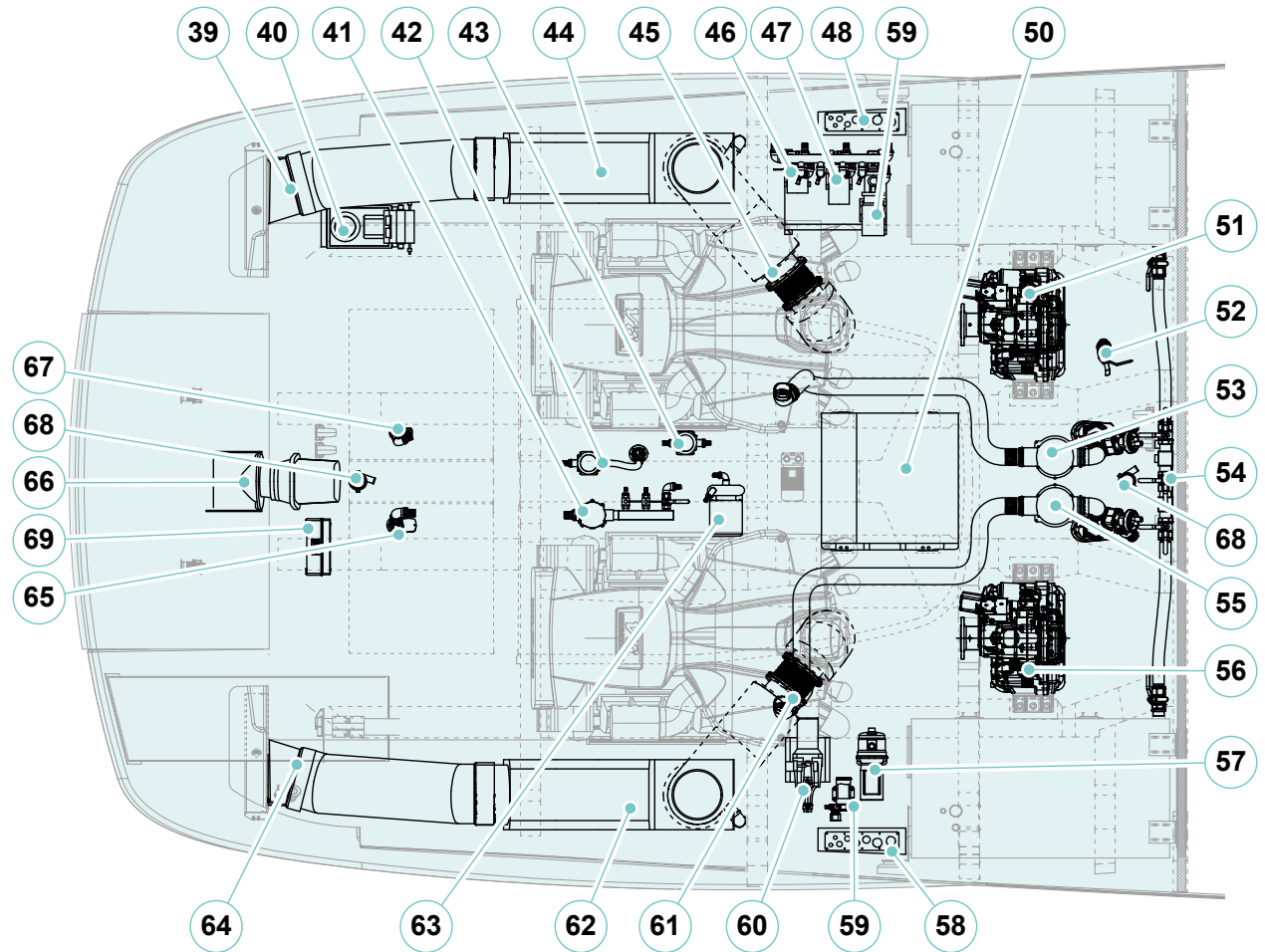

Riva

56 RIVALE *supera*

HELM STATION

CHAPTER 4

4.1 YACHT HELM STATION

The yacht is equipped with a helm station with rudder on the main deck.

The various navigation controls, instruments and devices are mounted in the helm station.



CAUTION

Herewith only general information for first start-up is given: for the practice and the specific use of the individual systems, consult the manuals of the Manufacturers or the RIVA After Sales & Service Department.



CAUTION

It is a good rule to keep the instruments clean by washing them with wet and clean rags, avoid using chemical or abrasive products. After navigation, it is advisable to cover instrumentation and equipment.

The helm station is divided into four sections, described below:

- A** Front section
- B** Port section
- C** Starboard section
- D** Starboard side panel

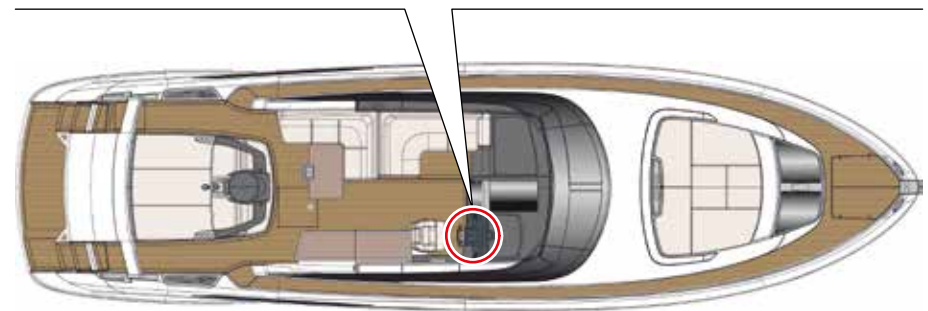
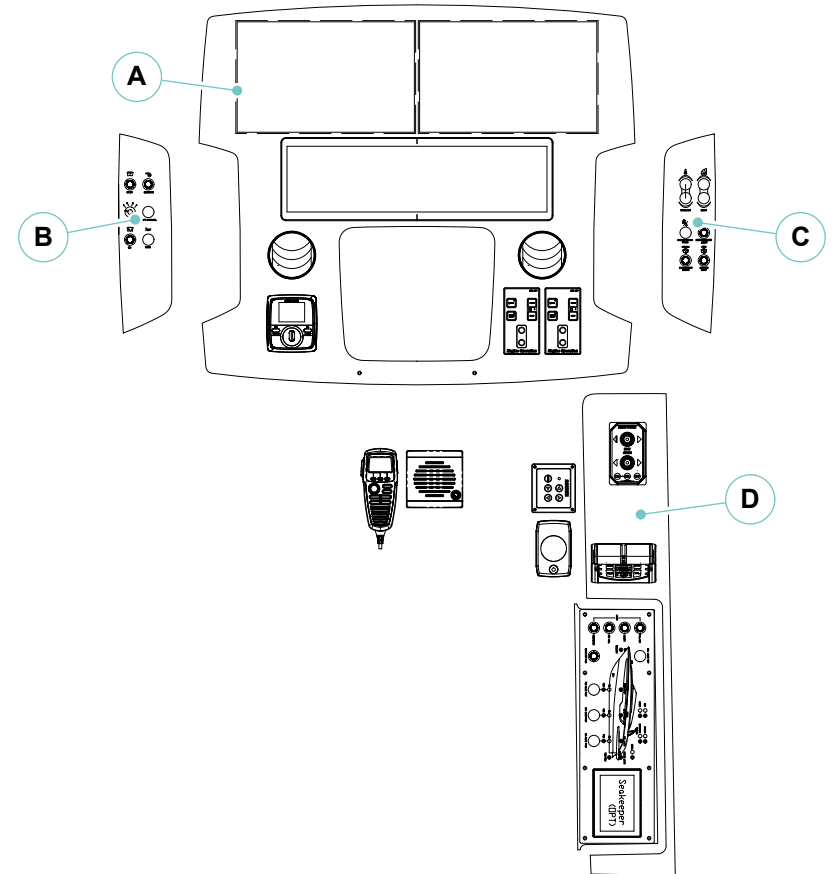

**CAUTION**

The helm station must be used only by the Captain or by the crew members authorised by the same.

The accidental activation of the controls installed in the helm station is a source of danger for the ship and its passengers.

**CAUTION**

HORIZONTAL FIELD OF VISION - View toward the stern.

Manoeuvres requiring visibility toward the stern must be performed from the helm station on the main deck in accordance with the requirements of ISO 11591.

**CAUTION**

All electric appliances for navigation, whose parameters can be configured and set by software through the control panel, have been configured and tested upon delivery. These operations must be performed exclusively by authorized service personnel. Any modification of the preset configurations can alter the operation and reliability of the concerned system. Appliances must be used by the personnel in charge of driving the yacht and of using the systems.

**CAUTION**

Refer to the specific manuals relating to the instrumentation on the helm station.

Strictly follow the instructions contained therein.

Field of view from the helm station

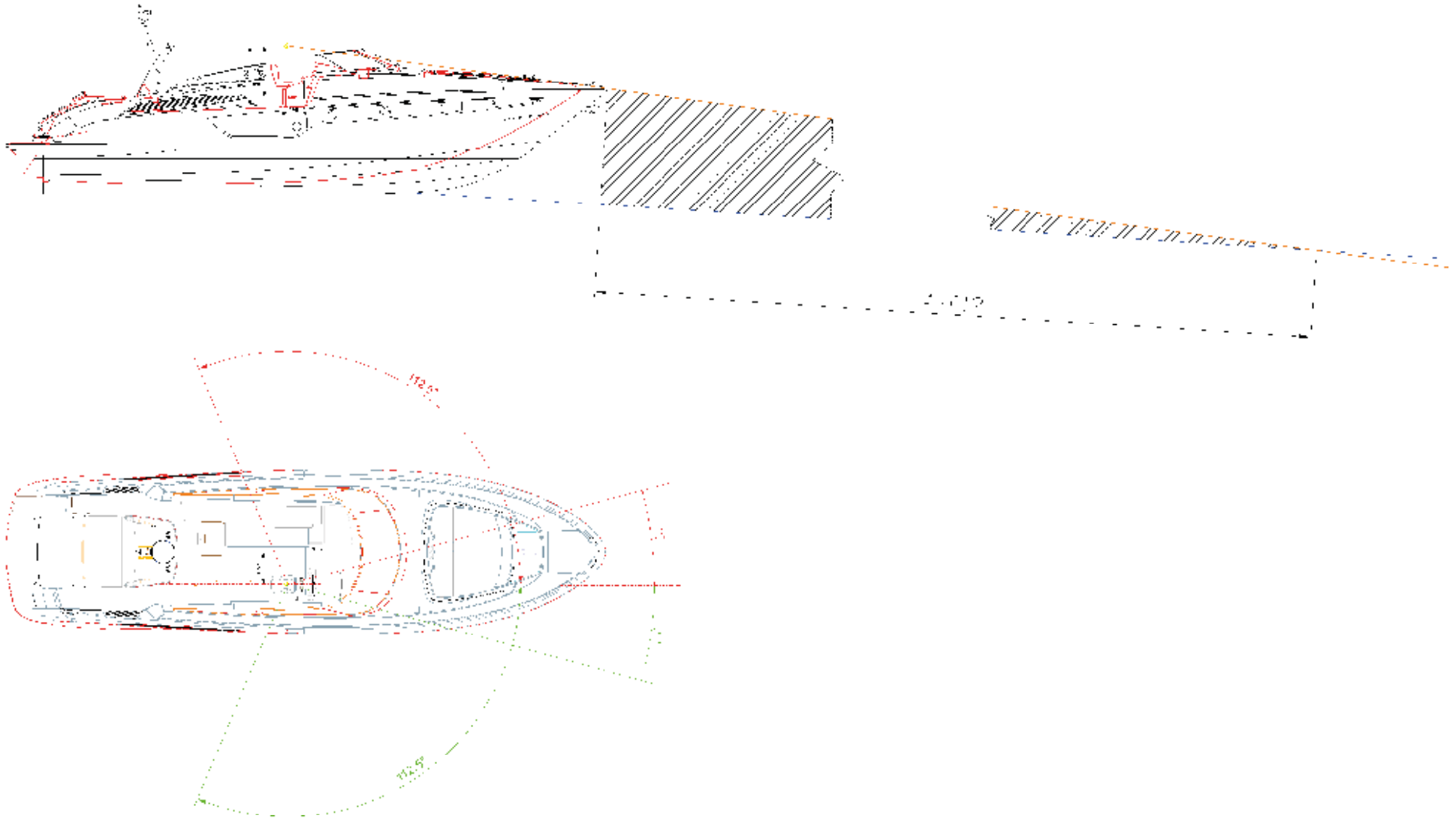

4.1.1 Front section

The front section of the helm station has the following utilities.

1. **Multifunction display**
Allows monitoring and management the navigation instruments, engines and on-board systems.
2. **Steering wheel**
It allows to govern the yacht's steering system.
3. **Air conditioning vents**
It allows to regulate and direct the flow of air conditioning.
4. **Engines ignition, start and stop panel**
It enables, by approaching the electronic key, the activation, switching ON and OFF of the engines and, if necessary, also allows the emergency stop of the engines.
5. **Interceptors control panel**
It allows to control / operate the interceptors system.

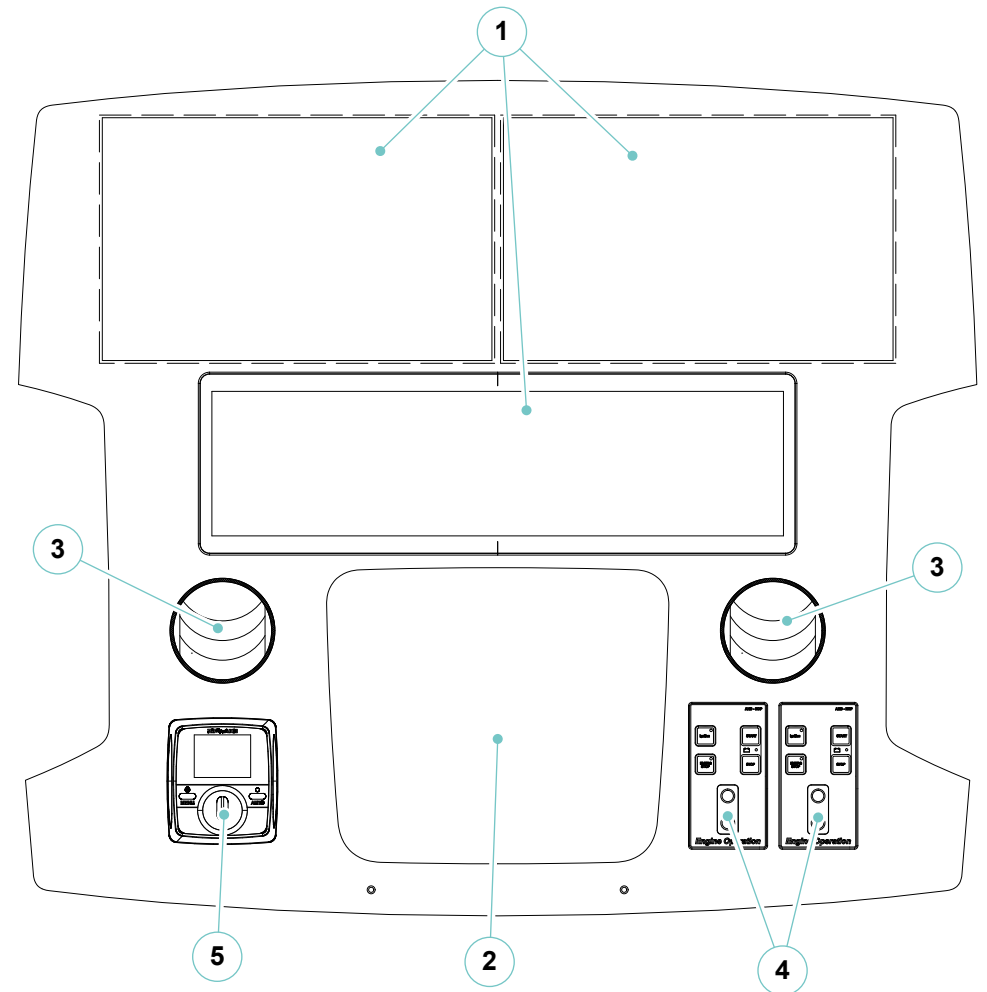

4.1.2 Port section

The port section of the helm station has the following utilities.

1. **Engine room air extractor activate button**
It allows to activate the engine room air extractor to facilitate the ventilation.
2. **Horn activation button**
It allows, if pressed, to activate the horn sound (for the pressure time).
3. **Wipers speed regulator**
It allows to increase or decrease the speed of the windscreen wipers.
4. **Wipers activation button**
It allows to activate or deactivate the wipers functioning.
5. **Washer activation button**
It allows to activate the dispensing of washer fluid.

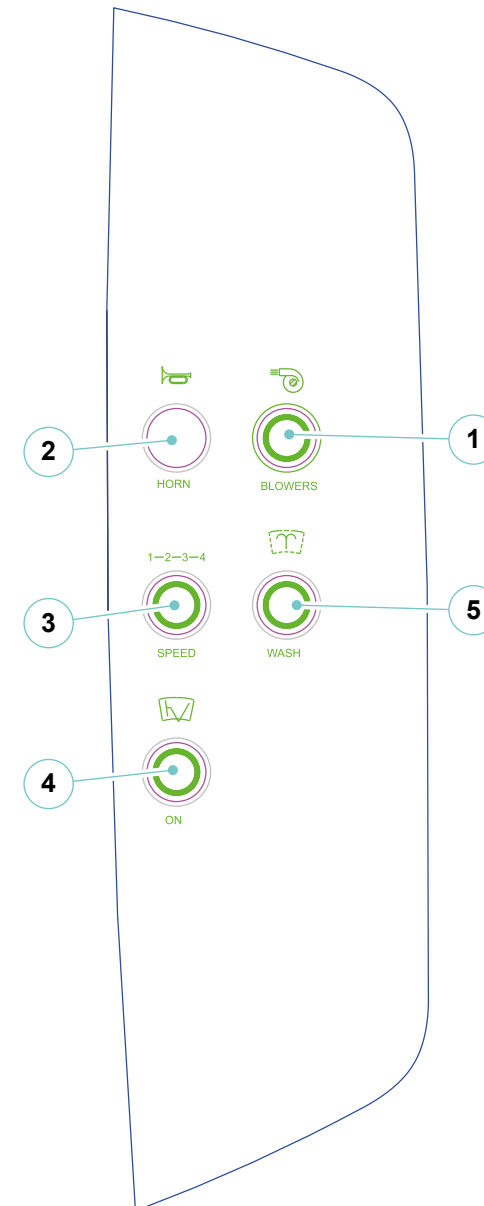

4.1.3 Starboard section

The starboard section of the helm station has the following utilities.

1. **Bimini control buttons**
Allow to control the bimini.
2. **Instruments lights activation button**
Allow to switch ON the instruments lights to improve the night navigation.
3. **Anchor light activation button**
Allow to switch ON the anchor light for the night navigation.
4. **Navigation lights activation button**
Allow to switch ON the night navigation lights.
5. **Chain wash activation button**
Allow to activate the anchor chain wash.
6. **Windlass activation button**
Allow to activate the winch to sail and drop anchor.

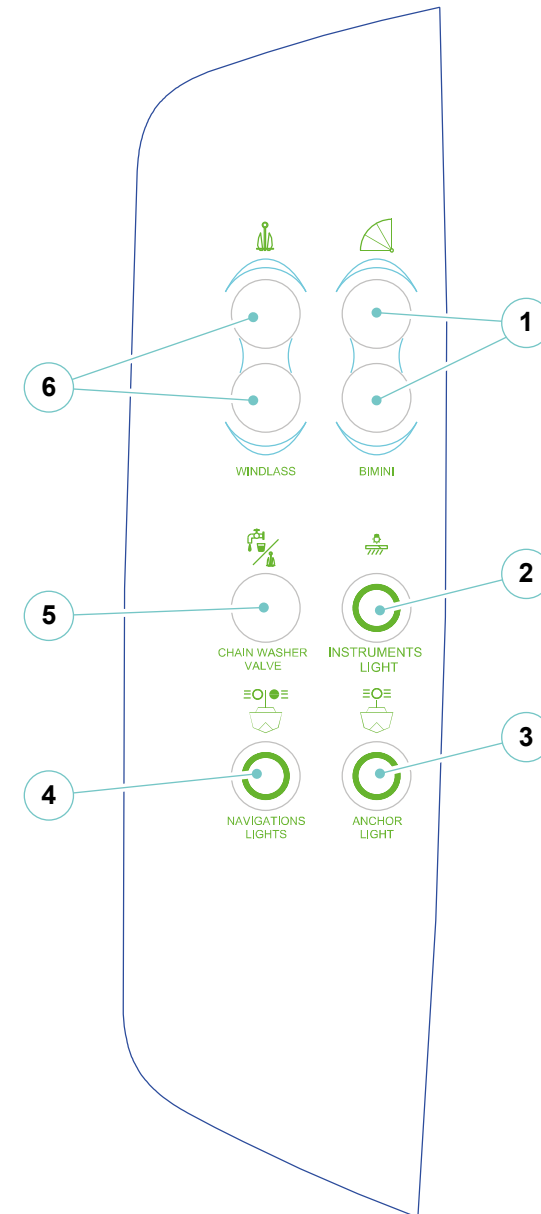

4.1.4 Starboard side panel

The starboard side of the dashboard is divided into two parts (upper and lower) and has the following utilities.

Upper section

1. Throttles

They allow the operation of motors and gearboxes to be controlled.

2. Thrusters control panel

They enable the operation and management of the thrusters.

3. Manoeuvring thrusters and main engines control joystick (optional)

It allows to make manoeuvres in confined waters easier, coordinating the whole steering instrumentation, including thrusters, inverters and positioning instrumentation, and controlling the yacht movements and rotations.

4. Synoptic panel

It allows, by means of relative buttons and lights to activate and manage the functioning of the bilge pumps, the windlass winch and to switch ON the on-board lights.

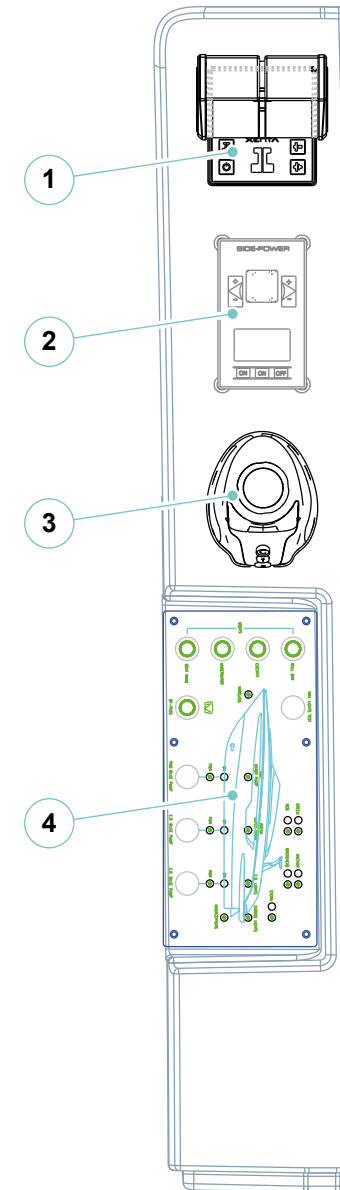

Lower section**1. Searchlight controls**

It allows to control the functioning of the searchlight.

2. Double USB port**3. VHF speaker with loudspeaker**

This device is a radiotelephone with digital selective call (DSC). The distress keys and calls are protected against accidental press. Single or group calls can be carried out with the key-pad taking advantage of the device directory or by dialling the number directly.

Your yacht is equipped with the AIS (Automatic Identification System) which allows to exchange informations with other AIS equipped yachts. This system allows to communicate the position, the course and the speed of your yacht.

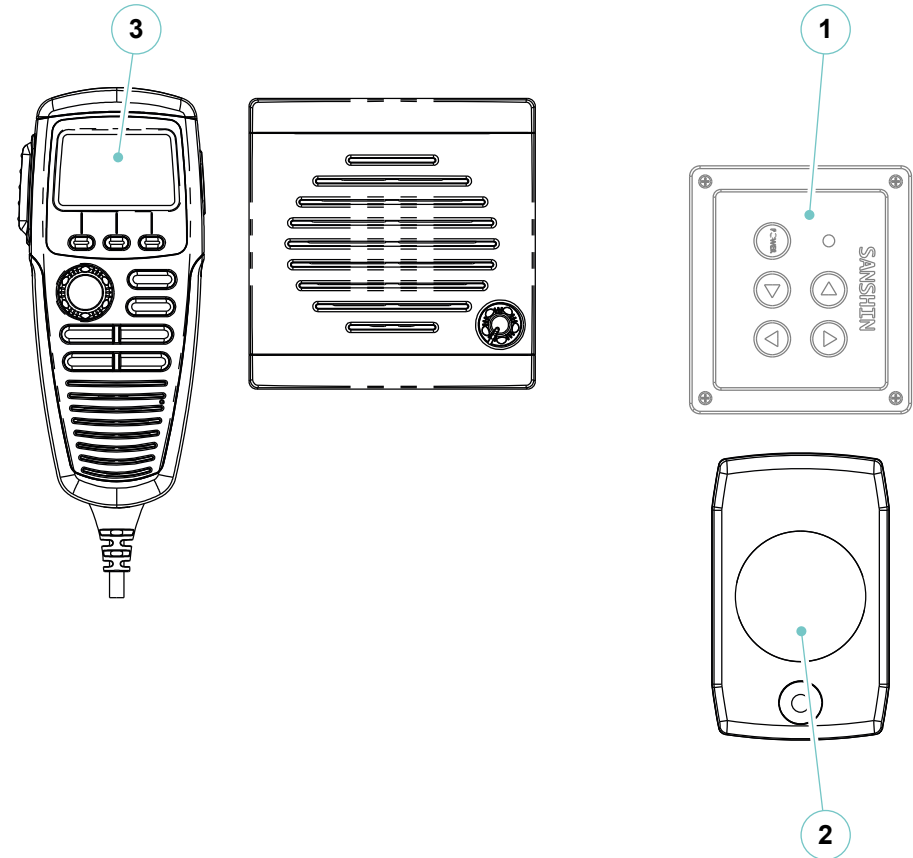

4.2 INSTRUMENTS

4.2.1 Synoptic panel

The synoptic panel is located on the starboard side of the helm station and has the following commands.

1. Lights switch ON buttons:

- Rollbar / Hard top (optional)
- Cockpit
- Underwater
- Boat name

2. Navigation lights test button

If pressed, switch ON all on-board lights to control any malfunction.

3. Wipers by-pass activation button

Allow to activate the wipers by-pass. The relative light indicator signal the functioning.

4. Forward bilge pump activation button

Allow to activate the forward bilge pump. The "PWR" indicator signal that the pump is correctly functioning, instead the "ON" indicator signal the effective functioning of the pump.

5. Engine room bilge pump activation button

Allow to activate the engine room bilge pump. The "PWR" indicator signal the pump is correctly functioning, instead the "ON" indicator signal the effective functioning of the pump.

NOTE

Moreover, is possible to control the functioning of the navigation lights by means the indicators located above the yacht profile. Other indicators allow to control the functioning of the fresh and sea water pumps and stern interceptor.

Versione roll bar standard / Roll bar standard version

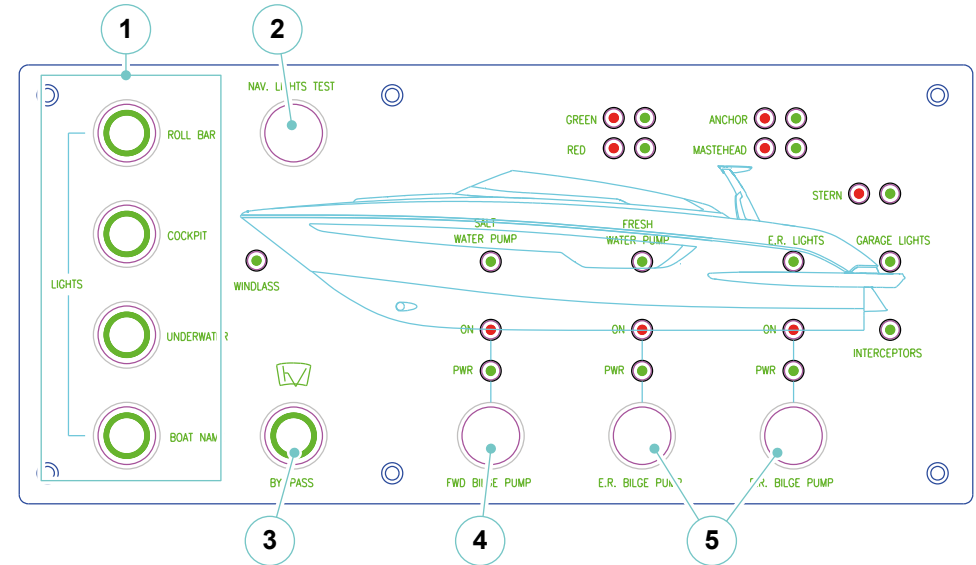

Versione hard top optional / Hard top optional version

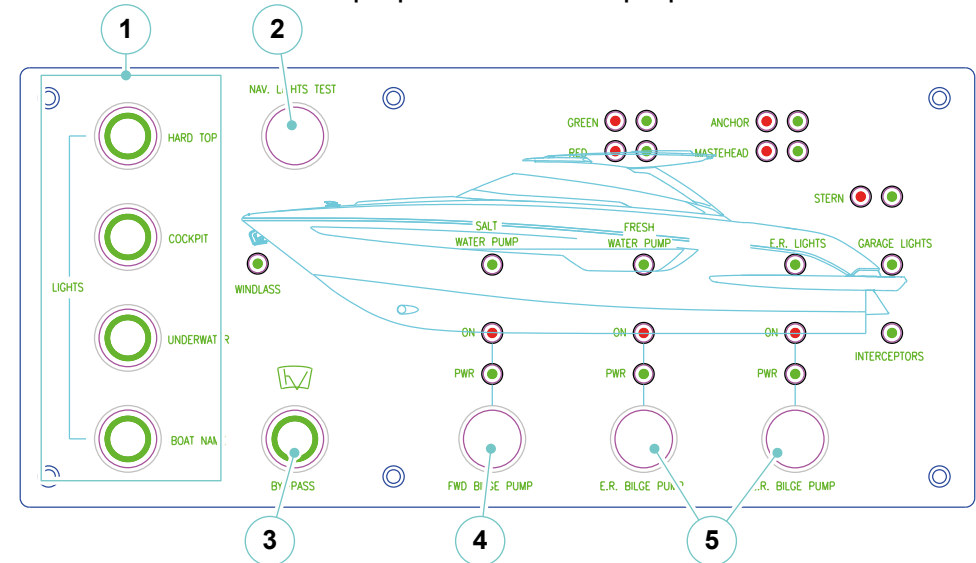

4.2.2 VHF-DSC Radiotelephone

Operate the radiotelephone according to following instructions:

- Power the device with the magneto-thermal located on the main electrical panel.
- Press ON/C key; as default setting the device switches on the priority channel (16) frequency. If the function “LAST CHANNEL USED” has been previously set, the radiotelephone will switch on the frequency of the last channel selected.

The display shows the channel number, the volume, and squelch levels.



WARNING

For channel selection or special function instructions, please refer to the radiotelephone Manufacturer's manual.

The keyboard has digital keys for the selection of the channels and function keys for the adjustment of the volume, of the squelch and of the scanning function.

The SHIFT key allows the access to the secondary functions.

The PTT key (press for transmission) located on the port side of the device, is activated when the receiver is unhooked from the holder.

Key 16 allows selecting the channel for vocal rescue request. It is however possible to carry out selective digital calls, quicker and simpler than the traditional calls. To obtain this, lift the protection flap placed on the front side of the radiotelephone.

Then press the DISTRESS key to get access to the various functions.

The VHF device allows communication on channels dedicated to Port Authority, rescue and radio stations.

To ask for rescue it is necessary to use the suitable VHF/FM channel: after each hour, as a legal rule, follow 6 minutes of silence, from minute 0 to minute 3 and from minute 30 to minute 33, so as to enable a better listening of the distress communications.

If the VHF is used, the distress call must be preceded and ended by the wording “**MAYDAY, MAYDAY, MAYDAY**”.

It is therefore necessary to give your position, the yacht's name, the kind of damage and the kind of help you require (medical, mechanical, etc..).



CAUTION

Perform the “**MAYDAY**” rescue call, only in case of real need.

If, listening to the distress channel, a distress call that has not yet received an answer is picked up, it is possible to send a “**MAYDAY RELAY, MAYDAY RELAY, MAYDAY RELAY**” forwarding the communication of the person who requested rescue.

It can in fact happen that the distress call, carried out on the open sea or by means of a poorly powered sender, is not received by the rescue team. Acting as a spokesman, you can help the message reach its destination successfully.



CAUTION

Perform the call “**MAYDAY RELAY**” only if there is a reasonable certainty that the message has not been collected by the rescue team so as not to engage the distress channel uselessly.

The use of the standard procedure avoids creating confusion and shortens the transmission time. In case of danger, use only the phonetic alphabet recommended.

The VHF device is a vital and important communication line; please remember some fundamental rules:

- No transmission should be performed without reason;
- Listen before transmission so as to avoid interference with other senders;
- For distress calls, use and hold the best possible wireless contact;
- Always use your call identification or the name of the yacht in order to make yourself identifiable. The use of names or family names is not allowed;
- Send short and clear messages;
- For distress calls it is important to give the yacht's position, the kind of danger, the time passed in water, the kind of yacht and the number of persons involved;
- For other calls, once the contact with the person called has been established, transfer the call on an operation channel;
- Cut out transmission if required by a coastal station;
- Retune the radio when the call is ended.

MANUAL DISTRESS CALL:

- Select the distress channel by pressing the 16/C button or by scrolling through the channels with the volume buttons.
- Press the transmission key "PTT" on the radiotelephone and carry out the communication.

MAYDAY - MAYDAY - MAYDAY THIS IS:

repeat the yacht's name for 3 (three) times.

MAYDAY THIS IS:

repeat the yacht's name.

AT POSITION:

specify the position of the yacht.

SPECIFY THE DISTRESS CAUSE.

- Release the "PTT" transmission key.
- Wait for the reply for a few seconds.
- If you do not receive any reply, repeat the message at regular intervals, until receiving a reply.
- When you receive an answer, continue the conversation:
 - Hold down "PTT" while talking.
 - Release "PTT" while listening.
- It may be required to switch to a working channel.

AUTOMATIC DISTRESS CALL:

- Lift the cover and press the DIST key; the display will show the wording “Distress call Undefined”.
- DIST hold for about 3 seconds, then displays the message: “DISTRESS CALL SENDING” and the radio beeps.
- The distress message will be automatically transmitted and repeated at irregular intervals on channel 70. Channel 16 will be available for communication after each transmission.
- If you do not receive a response after a short time, try to send the distress message manually.

**WARNING**

After the automatic SOS has been activated, it must be turned off by pressing the ON/C, otherwise the help message continues to be transmitted.

The SOS function is automatically locked until the number of DSC has been entered. Consult the manual provided by the manufacturer for the correct entry operations.

- You can press ▲ or ▼ to scroll through the transmitted Distress call information.
- You now have the following soft-key options:

RESEND

Displays “HOLD DISTRESS 3 SECONDS TO SEND”. You can then:

- Hold down the red “DISTRESS” key for 3 seconds to resend the call, or
- Press the “EXIT” soft key to return to waiting for an acknowledgement.

PAUSE

Pauses the call repeat mode. You can then:

- Press the “EXIT” soft key to resume the same call.

CANCEL

Displays “DISTRESS CALL SEND CANCEL.” You can then:

- Press the “NO” soft key to send the DISTRESS CANCEL signal.
- Press the “YES” software button to send the “Distress Cancel” signal;
- Press “PTT” and report your situation using the handset.
- When finished talking, press “X” to return to standby mode.

NOTE





For further information on use and maintenance, please refer to the manufacturer’s manual.

4.2.3 Throttle





The throttle is a system intended for control engine revolutions and inverter gears. It has the following features and performance functions.

- Sequential inverter and engine speed;
- Start interlock;
- High/low idle;
- Engine synchronization for several thrusters;
- Trolling solenoid valve control;
- Emergency protection against inversion;
- Inverter oil pressure interlock (optional).

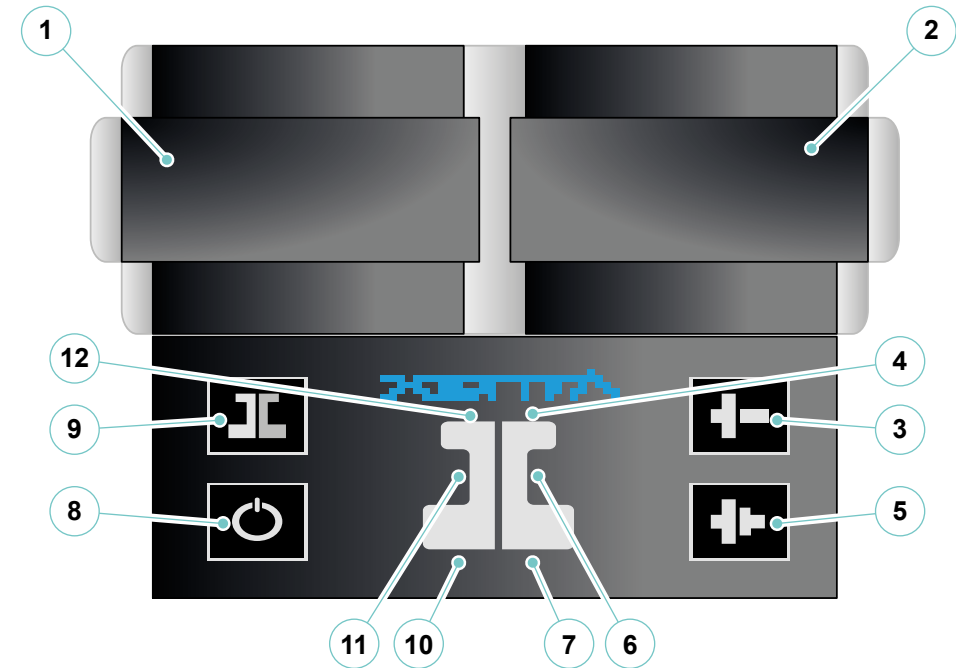
These features and functions make lever group use easier.

1. Throttle of port engine/inverter
2. Throttle of starboard engine/inverter
3. WARM UP  button
4. Control indicator – starboard
5. TROLLING  button
6. Throttle indicators – starboard
7. Gear and mode indicators – starboard
8. COMMAND  button
9. SINGLE LEVER  button
10. Gear and mode indicators – port
11. Throttle indicators – port
12. Control indicator – port



- **SINGLE LEVER** button  (9): it allows the activation of the **SINGLE LEVER** mode (after authorisation by means of the **COMMAND** button).
- **COMMAND** button  (8): it activates the throttle levers station and allows to confirm the activation of all the other operative modes.
- **WARM UP** button  (3): it activates the **WARM UP** mode (prior authorization by **COMMAND** button).
- **TROLLING** button  (5): it activates the **TROLLING** mode (prior authorization by **COMMAND** button). The **TROLLING** mode is an optional feature.
- Control indicator (4 and 12): it indicates the status of the starboard/port lever and reports the errors.
- Throttle indicators (6 and 11): they indicate the level of throttle requested by starboard/port lever.
- The more throttle is requested, the higher is the number of lights activated.
- Gear and mode indicators (7 and 10): In **THROTTLE** mode, they are both ON in solid blue if the port/starboard lever is in neutral. When the lever is in forward position, the top LED is ON in solid blue. When the lever is in backward position, only the bottom LED is in solid blue. In **SINGLE LEVER** mode, they are both on in fixed blue if the control lever is in neutral. When the lever is in forward position, the top LEDs are ON in solid blue. When the lever is in backward position, the bottom LEDs are ON in solid blue. In **WARM UP** and **TROLLING** modes they flash in blue giving an indication on the active operational mode.

The lights on the control panel of the control level provide information on the operational conditions of the system.

Control taking stages

- Make sure the throttle are in neutral. The station cannot take control when the levers are in other positions.
- Press twice the throttle switching on button, the LEDs go on indicating that the throttle is active.



WARNING

The following movement of the group lever of the throttle will engage the gear.

- Start engine and the neutral control at the same time. If the levers of the lever group are not in neutral, the interlock switch will not allow engine starting.
- Move the levers to the stop backward or forward. The drive system starts.

Basic operation

The throttle has three stops: backward, neutral, and forward.

With the throttle positioned on the “Neutral detent” stop, the system sends the neutral control and idle revolutions per minute.

By moving the lever of the throttle forward “Astern detent” or backward “Ahead detent” by 15° the backward/forward clutch engages.

The engine runs at the idle revolution number.

By moving the lever further, the engine revolution number increases proportionally compared to the lever of the throttle.

Indicator	Lever position
A	Full speed astern
B	Stop backward (idle astern)
C	Neutral stop
D	Stop forward (idle ahead)
E	Full speed ahead

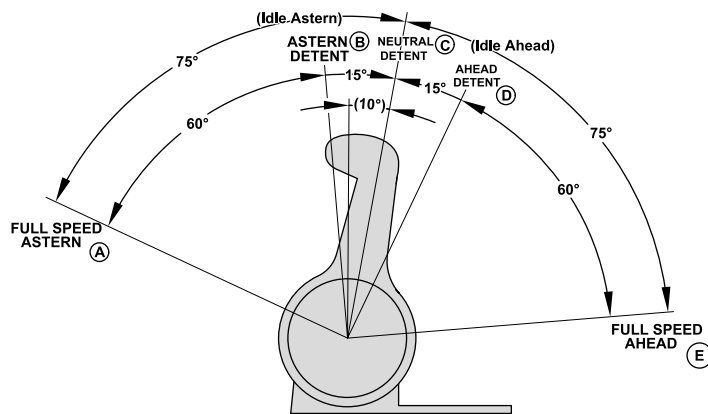

4.2.4 Magnetic compass

A magnetic compass fitted on the dashboard of a yacht is inevitably close to the magnetic fields produced by the electric and electronic systems on board. This condition is called “variation”.

Only a skilled technician should set the compass to correct the variation and supply an accurate deviation schedule. This procedure is called “compass compensation” or “compass setting”.

Compensate the compass after the yacht launch or when replacing it, in order to eliminate possible mistakes due to the compass position.

Do not approach the compass to steel or iron objects or objects made of other ferrous materials (e.g. tools, wrenches, batteries, etc..). The ferrous materials close to the compass alter the readings and make them unreliable. Remove any unnecessary object near the compass.

NOTE

The compass delivered with the yacht is not compensated for change or deviation. Any electrical or metallic item located in its proximity may influence the compass. The yacht’s owner is responsible for the compass compensation. Compensation should be carried out after installing additional electronic equipment or once a year after a prolonged period of mooring or ground lay-up. Compensation should be carried out only by authorized and qualified personnel. As a compass can rarely be set to zero variation on all courses, the technician in charge of its compensation should give you a card containing the corrections to be applied to navigation calculations. Always keep this card available on the main helm station.



CAUTION

The neutral stop (central position of the throttle movement) is 10° forward. The moving degrees are measured from this position, not from the vertical one.

NOTE

For further information on use and maintenance, please refer to the manufacturer’s manual.

NOTE

To compensate the compass , read the manual provided by the manufacturer.

4.2.5 Thrusters control joystick

The thruster control panel consist of an activating pushbutton (ON/OFF) and of a bi-directional joystick (starboard/port).

The joystick controls the 24V electric engines that drives the thrusters.

By remote control, you can access all the functions and commands of the various tools allowing safe navigation.



CAUTION

Remember to disconnect the power supply of the system when manoeuvres are ended or during normal navigation.



DANGER

During the thruster operation, pay attention to possible swimmers or small yachts which may be close to the thruster tunnels.
Always stop the thruster before undertaking inspection or maintenance tasks by disconnecting the switches and possibly also the battery terminals.

NOTE

For further information on use and maintenance, please refer to the manufacturer's manual.

4.2.6 Multifunction display

Radar/Chartplotter/Fishfinder:

The radar/chartplotter interlocks radar, Fishfinder, plotter, ais, autopilot.



DANGER

Radiation danger

The radar antenna emits radiations, which can damage the human body, especially the eyes.

When the radar is operating, never look straight at the transmission aerial from a distance shorter than 1m.

When the radar is in operation it is essential to stay out of the antenna's flow direction.

Turn OFF the radar when not strictly necessary for navigation.



WARNING

Be very careful when navigating, as a radar shadow forms near the yacht.



CAUTION

The electronic chart is an aid to navigation, designed to facilitate the use of authorized government charts, not to replace them. Only official government charts and notices to mariners contain all information needed for the safety of navigation and, as always, the Captain is responsible for their proper use.

MAINTENANCE

At least once a week carry out the cleaning of the LCD.
At least once every six months check the connection and the presence of corrosion on the cables.

MAINTENANCE

At least once a week check the correct operation.
At least once every six months check all connections.
When necessary have it calibrated.

Automatic pilot (autopilot):

The operation modes of the autopilot are following:

- AUTO (automatic control of the current heading as set course);
- NO DRIFT (advanced control of bow heading, cancelling the effects of wind, tides and rolling);
- NAV (track control);
- STBY (yacht control by means of the steering wheel).

The autopilot functions are checked by simply pressing the keys.

**DANGER**

When navigating with the autopilot enabled and if there is an obstacle in front of the yacht's bow, the best thing to do is set the device to standby in order to definitively take control of the yacht. Once by-passed the obstacle the device can be switched on by setting the track again.

**WARNING**

This instrument has been designed in order to offer the maximum precision and reliability; anyway its performance can be influenced by many factors. For this reason we recommend its use only as an help to navigation.

A careful and continuous monitoring has always to be kept also under the best navigation and sea conditions.

**WARNING**

Never place electric and/or electronic sources of any kind closer than 1 meter from the autopilot compass (particularly in presence of loudspeakers, transceivers, tool boxes, etc..) because they could jeopardize the operation and reliability of the autopilot.

**WARNING**

An autopilot is a very useful navigational aid, but DOES NOT replace under any circumstances a human navigator.

Do not use automatic steering when:

- In heavy traffic areas or in narrow waters;
- In poor visibility or extreme sea conditions;
- When in areas where use of autopilot is prohibited by law.

When using an autopilot:

- Do not leave the helm unattended;
- Do not place any magnetic material or equipment near heading sensor used in the autopilot system;
- Verify at regular intervals course and position of yacht.
- Always switch to Standby mode and reduce speed in due time to avoid hazardous situations.

NOTE

For further information on use and maintenance, please refer to the manufacturer's manual.

4.2.7 Steering wheel

The rudder wheel is connected by means of an electric actuator to an electro-hydraulic control unit, which moves the rudders via hydraulic drive systems (cylinders).

4.2.8 Steering joystick (optional)

It allows to make manoeuvres in confined waters easier, coordinating the whole steering instrumentation, including bow thrusters, inverters and positioning instrumentation, and controlling the yacht movements and rotations.

1. Joystick;
2. Command button and indicator (C);
3. Thruster button and indicator (T);
4. Engine button and indicator (E).

- **Joystick (1):** Controls all manoeuvres.
- **Command indicator (C) (2):** A blue light indicates the correct operation of the system. It turns red in case of problems. This button is used to activate the combined control of engines and thrusters.
- **Thruster indicator (T) (3):** A blue light indicates the correct operation of the thruster(s). It turns red in case of problems or malfunctions. This button is used to activate control of the thruster or the rudders.
- **Engine indicator (E) (4):** A blue light indicates the correct operation of engines. It turns red in case of problems or malfunctions. This button may be used to activate optional features.

The three lights on the joystick control panel provide information on the operational conditions of the system. They show both the system status and any malfunction, providing information about the first troubleshooting level:

- **C:** indicates the overall system status.
- **T:** indicates the status of the thruster(s).
- **E:** it indicates the status of the engines.



Each indicator has five possible states, providing a greater level of detail:

Solid red:	operation is blocked.
Flashing red:	operation failure.
Flashing blue:	operation is available for use.
Solid blue:	system in operation.
OFF:	system either turned OFF or unavailable.

All of functions of the system are activated via the **C**, **T** and **E** buttons situated on the joystick control panel. To activate the system, proceed as described below:

1. Make sure the Joystick is in neutral.
2. Switch both keys on.
3. Wait until the system switching on procedure is complete.
4. At the end of the procedure, the system will start the **STANDBY** mode automatically.

DYNAMIC POSITIONING mode (optional)

The **DYNAMIC POSITIONING** mode, when active, maintains the position and the heading of the boat. In calm wind conditions, with low currents, the **DYNAMIC POSITIONING** mode allows the pilot to hold the boat steady within 5 meters of a selected position.

When **DYNAMIC POSITIONING** is active, the boat's heading will also remain steady. **DYNAMIC POSITIONING** is based on GPS and compass data. The system automatically controls engines, gearboxes and thrusters to maintain the selected position and heading.

This allows the captain to keep the boat almost steady when, for example, waiting for refuelling, for a bridge to open or where anchoring is not allowed or feasible.

It is anyway always under captain's responsibility to keep under control the movements of the boats and the surroundings, watching for obstacles or any other kind of danger. It is captain's solely responsibility to always stay close to the helm station and react to any kind of danger that may occur.

When **DYNAMIC POSITIONING** is active, the pilot can still use the joystick to perform every action, as in **MANOEUVRE** mode.

When the joystick is put back in neutral, the system detects the boat's new position and heading and automatically controls engines, gearboxes and bow thruster to keep the position and heading steady.

To activate the **DYNAMIC POSITIONING** mode, proceed as follows:

1. Make sure the Throttle levers are at neutral position;
2. Make sure the Joystick is in neutral;
3. Press the C button to open the selection mode;
4. Press the T button once to reach the DP mode;
5. Press the C to confirm the activation.

X-AID (option)

X-AID automatically controls engine, gearboxes and thrusters to perform high-precision maneuvers, by carrying out controlled movements.

This allows the captain to have total control of the boat no matter how restricted the waters they maneuver in or the environmental conditions are. In fact, by integrating the management of engines and thrusters, **X-AID** has the ability to counter wind and current, making the use of the joystick even more effective, safe and intuitive.



CAUTION

It is always under captain's responsibility to keep under control the movements of the boats and the surroundings, watching for obstacles or any other kind of danger.

It is captain's solely responsibility to always stay close to the control station and react to any kind of danger that may occur.

To activate the **X-AID**, proceed as follows:

- Make sure the Joystick is in neutral;
- Press the **C** button to open the **SELECTION** mode;
- Press **T** button to scroll through the activable modes
- Press **C** to confirm the **X-AID** activation.

An intermittent sound will confirm activation of the **X-AID**.

If the joystick is not in neutral during the activation of the **X-AID**, the system will abort the request to prevent the boat from moving involuntarily.

When **X-AID** is active, the pilot can use the joystick to perform every action, as in **MANEUVER** mode and **DYNAMIC POSITIONING** mode is excluded. When the joystick is put back in neutral, the system slows the vessel down until it stops and it at this point automatically controls engines, gearboxes and bow thruster to keep the position and heading steady.

X-AID controls the acceleration and speed of movements for maximum safety, therefore it is recommended to activate **X-AID** just in the final stages of docking and it is recommended to use instead **MANEUVER** mode, when faster movements are necessary.

If any problem or malfunction would occur, the intermittent sound will be faster and may become fixed and may become fixed and prolonged.



CAUTION

It is captain's solely responsibility to react to this situation and take control of the yacht's commands.



CAUTION

X-AID is able to control the maneuver and maintain position within the yacht's capacity limits.

If the limits are exceeded, the captain must be ready to take the command and continue the maneuver in the traditional way.

When **X-AID** is active, swimmers must be kept away from the yacht because the engine and thrusters may cause sudden and dangerous water movements. The captain must make this clear to passengers before activating **X-AID**.

Before activating **X-AID**:

- Inform passengers that **X-AID** mode is about to be activated and can cause sudden or abrupt multi-directional movements.
- Check that no one is in the water near the yacht.
- Check that no one is sitting or standing where it could be possible to fall overboard during sudden or abrupt multi-directional movements.

While **X-AID** is active:

- It is captain responsibility for safe operation of the yacht. The captain should stay close to the engine controls and pay close attention to the area around the yacht.
- Always be ready to immediately disengage the **X-AID** at any time for any reason you determine could cause an unsafe situation (i.e. change in environment, low or lost GPS signal, diminished thruster performance due to low batteries, thermal protection or any other causes affecting the performance of the yacht).

Follow the normal safety procedures applicable when engine and thrusters are running.

Do not activate **X-AID**:

- When fast movements are necessary.
- When swimming people or any other kind of obstacles.
- When the anchor is in the water.
- When the yacht is tied or restricted in movements.

NOTE

For further information on use and maintenance, please refer to the manufacturer's manual.

4.2.9 WATCHIT system (optional)

WATCHIT is an advanced system intended to assist the captain in operating the boat in a safer way by providing an alert about potential risks both over and under the water.

This system processes data from the on-board sensors (GPS position, heading, speed, rudder angle, LOG, wind indicator, etc..) and from the maps data which allows to constantly assess the risk of collision and issue warnings in real time to prevent accidents at sea.



CAUTION

Do not use the system as a navigational tool as it is not intended as such. This system is intended only as an aid to navigation and does not substitute safe and alert yacht navigation and operation by a qualified operator.

Once the system was installed on board your yacht and was calibrated, there is no need to actively operate the system. The only action needs to be taken before leaving your port or marine is making sure the power supply switch/fuse is ON and the system will automatically power up.



The system has 4 modes of operation:

- **Normal Mode** – In this mode the system will generate a vocal an obstacle alert in case it has detected a potential hazard on the yacht's path. The alert will be heard 30 seconds before impact in order to allow enough time for the skipper to react.
- **Crowd Mode** – Whenever the system detects multiple objects in the near surrounding and the yacht speed is less than 15 Knots - the system will automatically switch to Crowd Mode and the vocal alerts will be replaced with Beeps to inform the captain about any potential risks. The beeps frequency will increase as the risking object will get closer to the yacht.
- **Anchor Mode** – Whenever the system has detected that the yacht has stopped – it will automatically switch to Anchor Mode. In case the system has detected the yacht is drifting, it will pop-up a Drifting Notification. After 5 minutes in case no one acknowledge the notification – a drifting alert will be triggered.
- **Marina Mode** – Whenever the yacht has entered a marina, the system will switch to Marina Mode. In this mode no vocal alerts will be heard.

NOTE

For further information on use and maintenance, please refer to the manufacturer's manual.

4.2.10 Back-up control panel

The XENTA system can be integrated with a **BACK-UP** control system, which guarantees the manoeuvrability of the yacht in the event of failure of the main electronic system.



CAUTION

It is always under captain's responsibility to keep the movements of the yacht and the surrounding area under control, paying attention to any obstacles or dangers. It is the captain's only responsibility to remain close to the helm station and to react promptly in case of danger.

- **BACK-UP panel (1)**: ensures navigation with reduced functions in case of XENTA system malfunction.
- **Power switch (2)**: activates the engines back-up commands.
- **Power switch (3)**: activates the rudders back-up commands.
- **LED operative indicator (4)**: a red light indicates the ignition and operation of the engines back-up commands.
- **LED operative indicator (5)**: a red light indicates the ignition and operation of the rudders back-up commands.
- **Port gear switch (6)**: activates the port engine control.
- **Starboard gear switch (7)**: activates the starboard engine control.
- **Port steering switch (8)**: activates the port rudder control.
- **Starboard steering switch (9)**: activates the starboard rudder control.

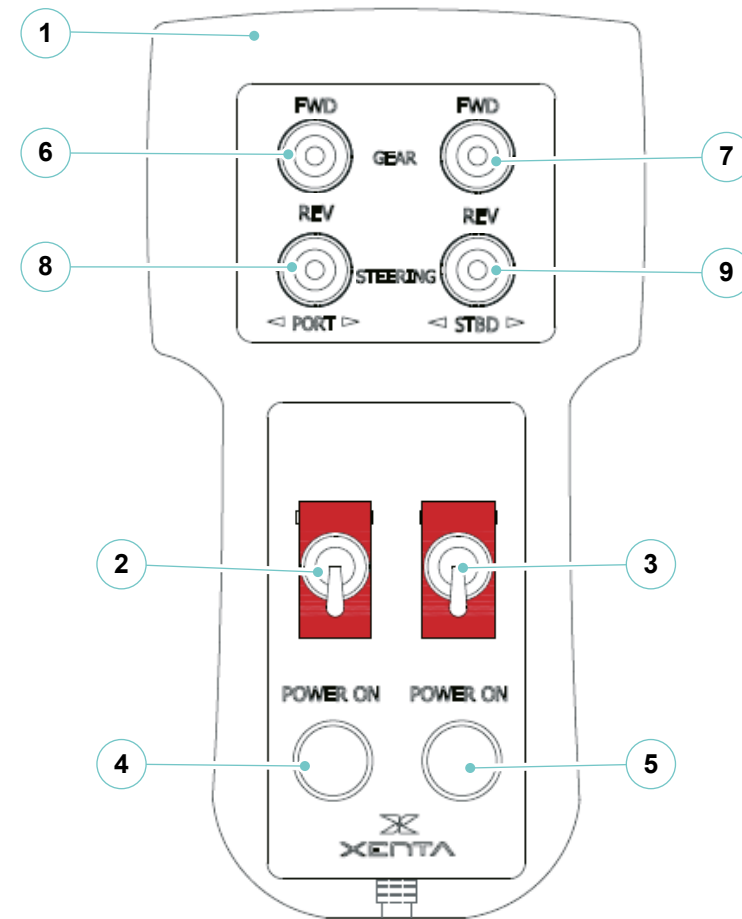

Functions:

Connect the **BACK-UP** panel to the relative connector installed on the helm station.

Activate the **BACK-UP** system, lifting the safety guard and bringing up the power switch of the back-up commands to be activated: the relative LED will light red to signal the activation of the required back-up commands.

Through the two upper switches (**6** and **7**) it is possible to gear the port and starboard engines forwards and backwards respectively, with a limited number of revolutions.

Through the two lower switches (**8** and **9**) it is possible to move both port and starboard rudders to port and starboard, allowing, therefore, the movement in emergency conditions of the steering system, ensuring the minimum manoeuvrability necessary to arrive in port and put the yacht in a safe condition.

**CAUTION**

In the event of a failure of the main steering system and, therefore, during the use of the back-up system, the relevant rudder position indicators may not function correctly. It is therefore the captain's responsibility to adapt the position of the rudders in accordance with the direction of travel of the yacht.

NOTE

For further information on use and maintenance, please refer to the manufacturer's manual.

Riva

56 RIVALE *supera*

WATER SYSTEMS

CHAPTER 5

5.1 FRESH WATER SYSTEM

The system consists of:

- Fresh water tanks;
- Shore connection;
- Freshwater inlet nozzle;
- Watermaker (opt);
- Autoclave pump;
- Water heater;
- Water distribution manifold.

The fresh water system includes two tanks with a total capacity of 530 litre located in the middle of the yacht.

The following connections are installed:

- **Water inlet**
The inlet is located on the starboard walkaround.
- **Fresh water suction**
It supplies water to the autoclave pumps which pressurise the entire cold/hot water circuit. The autoclave pump, in order to work, must be powered via the magneto-thermal breaker located on the main electrical panel.
- **Tank water level transducer**
It checks the fresh water level in the tank. The water level in the tank may be monitored through a panel on the helm station.

The system can also be supplied from shore.

The various utilities can thus be served without the aid of the on board autoclave thanks to the pressure of the shore water system.

The fresh water system is equipped with an autoclave pump with electronic pressure regulator, which requires:

- Less use of the batteries, as the pump activates only with high delivery requests;
- The pump continuous operation, eliminating the connection and disconnection phases;
- The device stopping the pump in case of water lack is installed on pump;
- The pump start after reaching the minimum pressure value set.

The panel with warning lights displays the various operation stages:

- Power ON (green light - voltage);
- ON (yellow light - pump runs for some seconds and brings the system under pressure 2.8/3 bar).

At utility connection the system starts the pump automatically, this latter stops when the utility disconnects, after resetting the system under pressure.

When faults occur, such as water leak or pipe clogging, the electronic regulator indicates the faults by means of "Failure" red light and stops the pump. The system restarts either by pressing the red Restart button, or by handling on the magneto-thermal on main electrical panel (by cutting out/in the pump voltage supply).



CAUTION

Before refilling the fresh water tank, check that the water supplied by the shore fresh water system is drinkable.

**CAUTION**

The fresh water circuit, and particularly the tanks, must be sanitized periodically by pouring in the case a specific disinfectant solution. We recommend in any case that the water coming from the on-board system not be drunk.

**CAUTION**

The inlet plug is marked "WATER" to avoid accidental introduction of different liquids. To avoid damage to the system and tanks, we recommend replenishing by gravity and not by pressure.

**CAUTION**

On yacht equipped with direct connection to shore fresh water, the maximum operation pressure should not exceed 2.8 bar and the pipes must be disconnected for safety reasons, if the yacht is left unattended. Although there is a pressure reducer, check the pressure from the pressure gauge installed on this regulator.

**WARNING**

It is a good norm to optimise the use of water, especially if navigating at open sea!

**CAUTION**

Regularly inspect the fresh water and bilge circuits for leaks. Repair any leaks by releasing the pressure in the system, in order to avoid damaging the furniture and the electrical equipment.







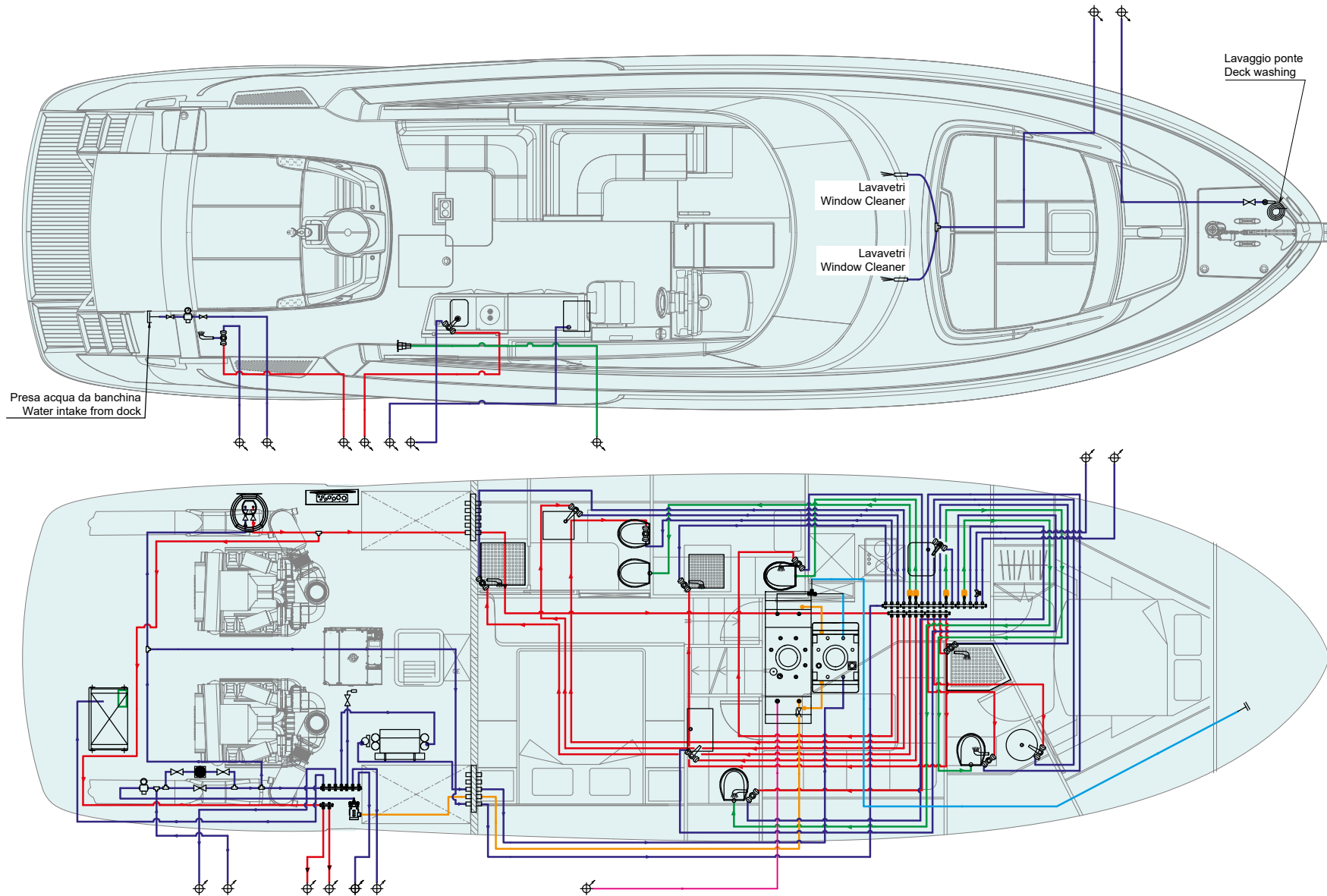



**CAUTION**

The pressure regulator at autoclave pump output is set at the factory; do not modify.

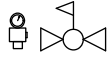
Fresh water system diagram:



ICONA ICON	DESCRIZIONE DESCRIPTION
	Valvola a sfera Ball valve
	Elettrovalvola per tergi Windshields electro valve
	Riduttore di pressione Pressure reducing valve
	Rubinetto lavastoviglie Tap
	Rubinetto lavasciuga Tap
	Gruppo lavello Wash basin
	Gruppo doccia Shower group
	Gruppo doccia Shower group
	Gruppo bidet Bidet group
	Preso acqua da banchina Shore water intake
	Tubo che sale Going up pipe
	Tubo che scende Going down pipe

ICONA ICON	DESCRIZIONE DESCRIPTION
	Elettrovalvola + filtro Electro valve + filter
	Valvola a sfera a tre vie Ball valve three way
	Valvola di non ritorno Non-return valve
	Ice-Maker Ice-Maker
	Riduttore di pressione Pressure reducing valve
	Filtro autopulente Self-cleaning strainer
	Autoclave Autoclave
	Collettore 1 via con saracinesca One way manifold with gate valve
	Collettore 2 vie con saracinesche Two way manifold with gate valve
	Collettore 3 vie con saracinesche Three way manifold with gate valve
	Collettore 4 vie con saracinesche Four way manifold with gate valve

ICONA ICON	DESCRIZIONE DESCRIPTION
	Boiler Water heater
	Rubinetto porta manichetta Hose basin
	Serbatoio acque dolci Fresh water tank
	Serbatoio acque dolci Fresh water tank
	Ugello lavavetri Windshield sprinkler
	Sfiato cassa acqua dolce Fresh water air vent
	Tappo imbarco acqua dolce Fresh water intake cap
	Passapatia Bulkhead connector
	Manichetta lavaggio ponte Deck washing
	Dissalatore (optional) Watermaker
	Unità aria condizionata Air conditioning unit

5.1.1 Cold fresh water system

The system is kept under pressure by a autoclave pump.

The pump supplies the system by drawing water from the tank; the water flowing through pipes and manifolds supplies following services:

- Bathroom;
- Galley sink;
- Windscreen wiper;
- Air conditioning unit;
- Dishwasher;
- Water heater;
- Icemaker;
- Deck washing hose;
- Cockpit sink;
- Shower on stern platform.
- Chain washer;
- Cockpit fridge.



WARNING

Before activating the system, ensure the proper position opening/ closing of the manifold valves: valve open, lever parallel to input hose, valve closed, lever perpendicular to input hose.



WARNING

During navigation and, in general, when the water in the tank is used, we remind closing the valve fitted on the shore inlet line, located in the engine room.

If the yacht is moored in a marina that includes running water service, the equipment can be supplied without using the yacht's autoclave, due to the shore system's pressure.

The connection to the running water system from the shore is carried out by means of the water inlet located at the stern on the starboard side.

A pressure reducer, located in the engine room, protects the yacht's water system against harmful pressure variations.

The fresh cold water reaches all utilities through the distribution manifolds, provided with check valves in order to enable the sectioning of the system in case of failure or maintenance. The distribution manifolds are located in the engine room and in the galley bilge.

NOTE

For further information on use and maintenance, please refer to the manufacturer's manual.

5.1.2 Hot fresh water system

The autoclave pump takes cold water from the freshwater tank and sends it to the electric water heater, positioned located on the port side of the engine room.

The water contained in the water heater is heated and subsequently reaches the following uses:

- Shower on stern platform;
- Bathrooms;
- Galley sink;
- Cockpit sink.

Hot freshwater reaches all uses through distribution manifolds, which are equipped with shut-off valves to allow the system to be sectioned off in the event of a breakdown or for maintenance.

The water heater is powered by 230 V electricity supply.

To use hot water:

- The magneto-thermal switches for the water heater and autoclave, on the main switchboard, must be in the ON position;
- A power source (generator or shore) must be active;
- The service battery cut-off switch must be in the ON position.

The water inlet and outlet lines from the water heater can be shut off by means of ball valves.

A non-return valve is fitted to the inlet line to prevent hot water from flowing back into the circuit.

This valve shall be checked and replaced according to the indications given by the manufacturer.

NOTE

The water heater is not an accumulator: wait that goes up to temperature.



WARNING

To activate the water heater, either activate the generator or get connected to shore mains, without forgetting to check the current amperage of the harbour you are moored into.



WARNING

Never switch on the electric resistance if the water heater is empty.

NOTE

For further information on use and maintenance, please refer to the manufacturer's manual.

5.1.3 Watermaker (optional)

To solve the problem of water supply and to ensure a constant availability also during long navigations, the yacht has been provided with an efficient watermaker system.

The watermaker is installed in the engine room and, by means of an electric pump, sucks sea water through the service sea cock and, after filtering and treating it, sends it to the on-board tank.

Before the sea water is treated, it is filtered in order to remove all “suspended” particles, such as small seaweed and impurities in the water, which could clog the inner membranes of the watermaker, even within a short amount of time.

The watermaker can produce bacteriologically pure water which can therefore be used for all on-board applications.

Excess water and salt concentrate are discharged overboard. In order to prevent the problem of the deposit of salts on the inner membranes and their crystallization over time, the system has been provided with an end-of-cycle flushing system which uses fresh water. Given the importance of this operation, clean the inner membranes of the watermaker according to the procedures and the schedules indicated by the manufacturer.

On the general electrical panel in the engine room (230V mains), there is a magneto-thermal breaker which supplies and protects the watermaker system.



CAUTION

The watermaker is to be kept in good condition by scrupulously following the indications in the specific manual.
Bad maintenance can lead to production of non-potable water unsuitable for food use.



CAUTION

The watermaker does not eliminate all dangerous agents present in polluted waters (see specific manual).
Use the watermaker only in clean waters, to avoid contamination of its membranes, tanks and of the whole circuit.



CAUTION

In order to prevent clogging the watermaker filters and membranes, do not use the system where sea water is dirty or contains a great deal of sand in suspension.

MAINTENANCE

At least once a month verify:

- The correct operation;
- The oil level in the pump.

Periodically perform a fresh water washing cycle. At least once a year, change the oil of the pump.



When necessary clean the filters.

NOTE





For further information on use and maintenance, please refer to the manufacturer's manual.

5.1.4 Maintenance fresh water system

Component	Maintenance	Notes and precautions
Fresh water tanks	Cleaning and checks	<p>At least every month, drain the fresh water tanks completely and rinse them a couple of times with clean fresh water for change completely the water stowed in the storing tanks and at the same time to wash them too.</p> <p>Periodically pour a specific disinfectant, in the quantity recommended by the Builder, into the tanks, through the intake filler, in order to prevent the formation of bacteria in the system.</p>
Electric water heater	Cleaning and checks	<div style="border: 1px solid black; padding: 5px; margin-bottom: 10px;"> <p style="text-align: center;">MAINTENANCE</p> <p>At least once a month check the operation of the water heater. At least once a month check the operation of the relief valve. At least once a year carry out the thermostat calibration, and if necessary, have it calibrated again. At least every two years descale the resistor.</p> </div> <div style="border: 2px solid yellow; padding: 10px;"> <p style="text-align: center;"> CAUTION</p> <p>If warm water is not available, because of the fresh water circuit discharge, switch OFF the water heater to prevent damaging it resistor.</p> </div>

Component	Maintenance	Notes and precautions
Fresh water system	Checks	<p>In case of need or of maintenance, by acting on the valves installed on the distribution manifolds, it is possible to cut out parts of the system or single uses, without involving the operation of the general system.</p> <p>Check if along the hydraulic circuit, where possible, are present leaks due to the damage of piping.</p> <div data-bbox="857 472 2074 663" style="border: 1px solid orange; padding: 10px; margin: 10px 0;"> <p style="text-align: center;"> WARNING</p> <p>The high temperature can cause the softening of the pipes and the following slackening of the fittings. Always check the pipes tightening, especially those located near heat sources.</p> </div> <div data-bbox="857 707 2074 898" style="border: 1px solid orange; padding: 10px; margin: 10px 0;"> <p style="text-align: center;"> WARNING</p> <p>During the winter, if you do not use the yacht, it is advisable to drain all the circuits where there is fresh water to avoid cracks due to frost.</p> </div>

Component	Maintenance	Notes and precautions
Autoclave pump	Cleaning and checks	<p>The maintenance of the pump should be serviced by qualified personnel only, after having been disconnected from the power mains.</p> <p>No routine maintenance is required so long as the following precautions are taken:</p> <ul style="list-style-type: none"> • In case of freezing risk, it is necessary to empty the pump body; then refill the pump before operating it but make sure the ambient temperature is higher than the water freezing temperature. • Make sure the pump never works dry. • If the pump remains unused for a long time, it is better to empty the body and clean it. • Periodically check the efficiency of valves and strainers. • To Direct Current motors the brushes must be periodically checked for consumption and spring pressure. <p>Protect electric components of the pump with proper products.</p> <div style="border: 1px solid black; padding: 5px; text-align: center;"> <p>NOTE</p> <p>For further information on use and maintenance, please refer to the manufacturer's manual.</p> </div>

Component	Maintenance	Notes and precautions
Autoclave pump	Cleaning and checks	<div data-bbox="864 264 2074 600" style="border: 1px solid orange; padding: 10px;"> <p style="text-align: center;"> WARNING</p> <p>The surge tank pump is self-priming but it needs though, in order to operate, to have its body filled with liquid. For a correct use, we recommend priming first or after a long period of idling, to fill the pump body with liquid, to check the pressure inside the tank (it must have the same pressure priming the electric pump) and to verify the clockwise rotation of the pump (seen from the engine side).</p> </div> <div data-bbox="864 639 2074 831" style="border: 1px solid orange; padding: 10px;"> <p style="text-align: center;"> WARNING</p> <p>If the control panel shows the pump operating led remains always lit, but the connected uses are not in use, check for leaks.</p> </div> <div data-bbox="864 879 2074 1110" style="border: 1px solid orange; padding: 10px;"> <p style="text-align: center;"> WARNING</p> <p>When anomalous situations occur, such as lack of water or pipes clogging, it indicates the presence of faults by means of the red light "Failure" and stops the pump. By pressing red button (reset) the system restart.</p> </div> <div data-bbox="864 1158 2074 1313" style="border: 2px solid red; padding: 10px;"> <p style="text-align: center;"> DANGER</p> <p>Before carrying out maintenance on the fresh water pump, avoid its accidental priming.</p> </div>

5.2 GREY WATER SYSTEM

Grey drainage waters are collected inside the structural tank located at the center of the yacht, which has a capacity of 120 liters (32 gal).

The tank collects the discharge water from basins, showers and the condense water of the air conditioning system fan-coil.
The tank, not being airtight, does not need any air vent.

From the tank, through a pipe that reaches the grey water pump located in the engine room, the water is discharged into the sea through a centralized drain located in the engine room.

The pump supply magneto-thermal switch is located on the 24V main switchboard, together with a light indicating its operation.

The pump is automatically controlled by an electronic level switch installed inside the tank. The grey water pump starts when the sensor detects a high water level and deactivates once the water level has lowered.
Furthermore, to facilitate the collection of grey water inside the tank, there are two collection boxes with a dedicated pump.

The grey water pump has two operating modes, automatic and manual, which can be selected via a control on the main switchboard.
In "AUTOMATIC" mode, reaching the medium level enables the pump, which remains active until the low level is reached.
If the pump is active, switching the auto/manual selector stops the pump.
In "MANUAL" mode, press the "MAN" button to start the pump.

The pump remains active until the low level is reached.
If the level is lower than the low level, the pump will not start, not even pressing the "MAN" button.

NOTE

The tank level should always be checked using the warning lights on the main electrical panel or, in any case, it should be emptied under manual control before entering port to avoid having to sail out to the sea again to empty it.



CAUTION

The alarm is triggered with the high contact of the main grey water tank, but the fresh water pump is not disabled.



ENVIRONMENT

Do not discharge soapy waters drained by washing machines and dishwashers in the harbour, inside marinas or near beaches, because of the large amount of foam produced.

To allow a regular flow and to avoid the formation of bad smell and gas, the tank is equipped with anti-odour siphons.



WARNING

Do not pour any corrosive product into the washbasins or showers or products at high temperatures, as they could cause damage to the grey water system.

**CAUTION**

Totally empty the system and the grey water tank before the lay-up period in order to prevent any problems with freezing.

MAINTENANCE

At least once every three months:

- Carry out the complete cleaning of the tank;
- Carry out the complete cleaning of the pump.







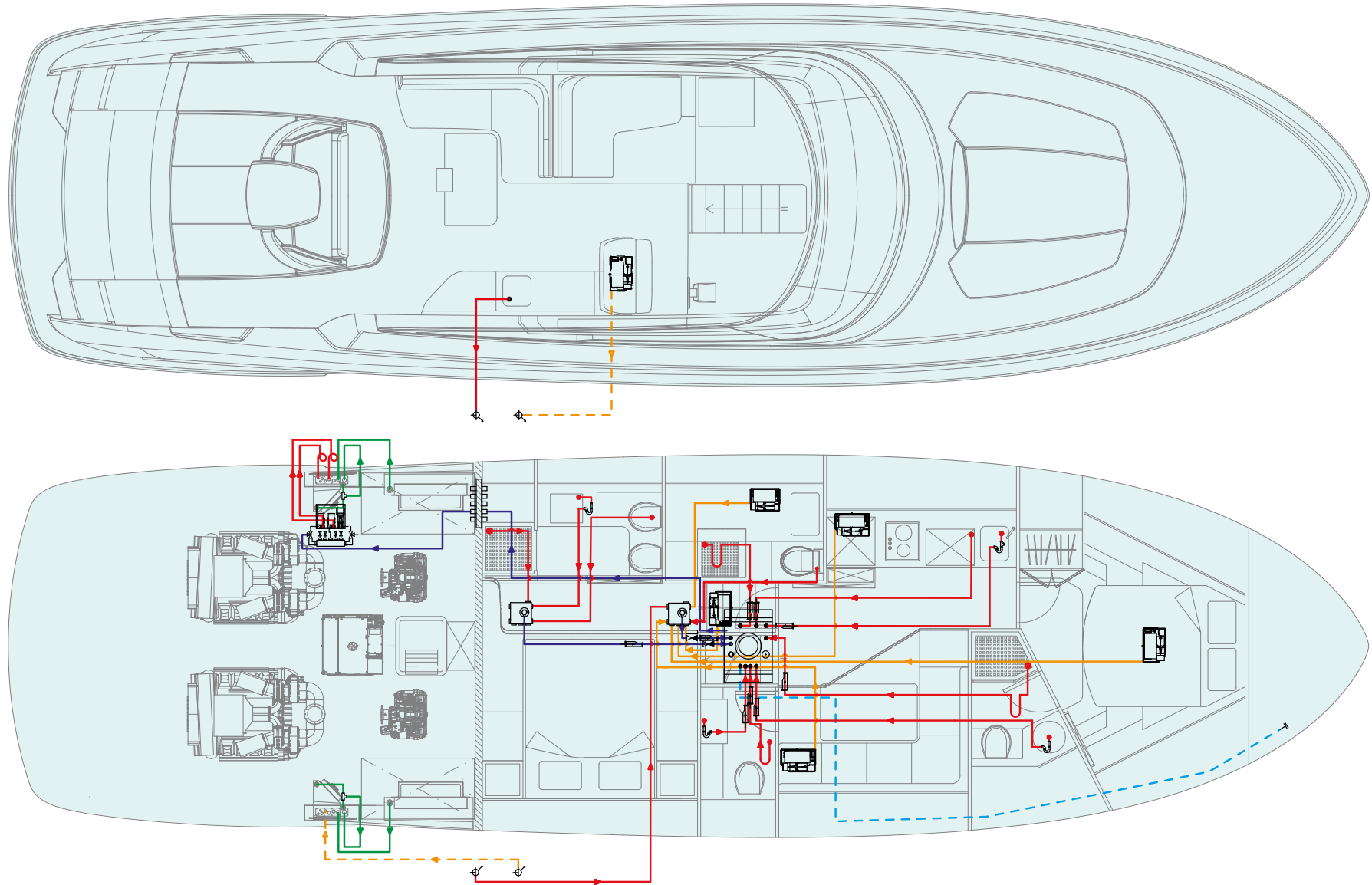

At least once every six months check the status of the pump.

**CAUTION**



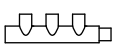





Do not activate the grey water pump manually if the level for the automatic stop is the lowest, to keep the pump primed.

Grey water system diagram:



ICONA ICON	DESCRIZIONE DESCRIPTION
	Valvola a sfera a 3 vie 3 way ball valve
	Valvola a sfera Ball valve
	Elettropompa Electropump
	Collettore 3 vie 3 way manifold
	Collettore 4 vie 4 way manifold
	Vasca raccolta condense Condensate collection tank
	Scarico fuori bordo Overboard discharge
	Bocchetta sfiato aria Air vent outlet
	Passaparatia Bulkhead

ICONA ICON	DESCRIZIONE DESCRIPTION
	Collettore di raccolta Collection manifold
	Tubo che sale Pipe going up
	Tubo che scende Pipe going down
	Collettore 4 vie 4 way manifold
	Collettore scarico a murata centralizzato Centralized sidewall exhaust manifold
	Fan-coil Fan-coil
	Cassa raccolta acque grigie Grey water collection tank
	Sensore elettrico allarme funzionamento pompa Electric pump operation alarm sensor
	Valvola di non ritorno Non-return valve

ICONA ICON	DESCRIZIONE DESCRIPTION
	Sifone lavelli bagno Bathroom sink siphon
	Sifone lavello cucina Galley sink siphon
	Sifone antidori Anti-odor siphon
	Linea di scarico Discharge line
	Linea scarico condense Fan coil Fan coil condensate discharge line
	Linea di ventilazione Vent line
	Aspirazione dalla cassa Suction from the tank
	Linea di scarico condense prese aria Condensate drain line for air intakes

5.3 BLACK WATER SYSTEM

The black water system installed on board the yacht consists of a 170 litre (45 gal) capacity black water collection tank, positioned amidships.

The system vent is located at the stern, on the port side. Before being discharged outside, the vented air passes through an activated charcoal filter to eliminate unpleasant odours.

The tank is equipped with a level switch which starts the discharge pump when it detects a high black water level, and deactivates it once the level has decreased.

The level switch measures the water level inside the tank and sends alarm signals to the main electrical panel and to the WC control pushbutton panels.

The electric WC system is supplied and protected by the magneto-thermal switch located on the main electrical panel; it must be activated in order to allow WC operation.

A pump, in the engine room, empties the tank via a suction line, which discharges through the WASTE outlet located at the stern, on the port side.

The pump has two operating modes, automatic and MANUAL, which can be selected via a control on the main switchboard.

In "AUTOMATIC" mode, reaching the mid-level threshold triggers the pump, which remains active until the low level threshold is reached.

In "MANUAL" mode, the "MANUAL DISCHARGE" control on the main switchboard must be activated to start the pump.

The pump remains active until the low level is reached.

If the level is lower than the low level, the pump will not start, not even pressing the "MAN" button.



CAUTION

Within 12 nautical miles from the coast it is forbidden to discharge the black water tank into the sea; it is necessary to keep the discharge pump inactive and to exclude the automatic activation.

The option of unloading the sewage tank at the shoreside and transferring its contents to the on-shore sewerage system is the solution with the least environmental impact, which should be adopted whenever the yacht is moored in an equipped place.



CAUTION

Before leaving the harbour, check the indicators of level of the black water tank on main deck panel to perform, if necessary, the suction from the shore supply.

Procedure for emptying through the shoreside nozzle.

- Handle the hose by paying attention not to soil the teak, and dampen it ahead of time.
- Correctly fit the outlet for shore drain by means of the screw connection.
- Take advantage of harbour services for sewage intake with vacuum system.
- Once the operation is completed, disconnect the hose correctly by paying attention again so as not to soil the teak. If necessary, rinse.

Before entering shore, you should check the tank level and decide whether you should discharge at sea or use the port facilities by checking in advance if the your destination port is equipped for tank emptying through the aft starboard nozzle.

To increase the reliability and safety of the system, in case of a fault in the black water pump, it is possible to drain by means of the grey water pump. Under such conditions, it is necessary to ensure the proper opening of the concerned manifold valves.

**CAUTION**

During the suction black water from the shore is strictly prohibited to:

- Use the toilet;
- Press the command button then operate the pump discharge over-board.

**WARNING**

Before use, make sure:

- Enabling the utility by setting the WC system magneto-thermal switch on the main switchboard to ON if necessary;
- The absence of the high tank level warning light.

**CAUTION**

It is advisable to routinely monitor the sewage level via the indicators on the main switchboard in order to optimise the use of the retention system in accordance with local environmental regulations.

**CAUTION**

The suction outlet, is labelled with a “WASTE” indication, in order to avoid the accidental penetration of liquids such as water or fuel.

**CAUTION**

In case of sinking hazard, if escaping condition allow you this, close the ball valve of the black water drain.

**CAUTION**

Totally empty the system and the black water tank before the lay-up period in order to prevent any problems with freezing.

**CAUTION**

For all pleasure yachts, drain at sea of on-board toilets is forbidden inside harbours, landings and moorings dedicated to yachts' anchor riding, and also within the limit of beaches visited by swimmers, as stated in the single regulations of the Port Authorities.

**CAUTION**

Direct sea discharge can only be carried out in the event of an emergency.

The holding tank is equipped with a sea water washing system. In order to wash the tank, you have to open the valve concerned, located on the tank door, and start the concerned pump.

This operation has to be performed periodically at a variable time interval, according to the use of the tank.

In addition to this, we recommend constantly checking the filling of the tank, so as to disconnect the pump when necessary.

**WARNING**

The valve for washing the holding tank must always be closed, except for during washing operations. If the valve remains open, the tank can be flooded and sea water can be boarded.

**WARNING**

The holding tank washing must be performed only in compliance with legislation in force, in the harbour, only under provided it is connected to the disposal facilities on land.

**WARNING**









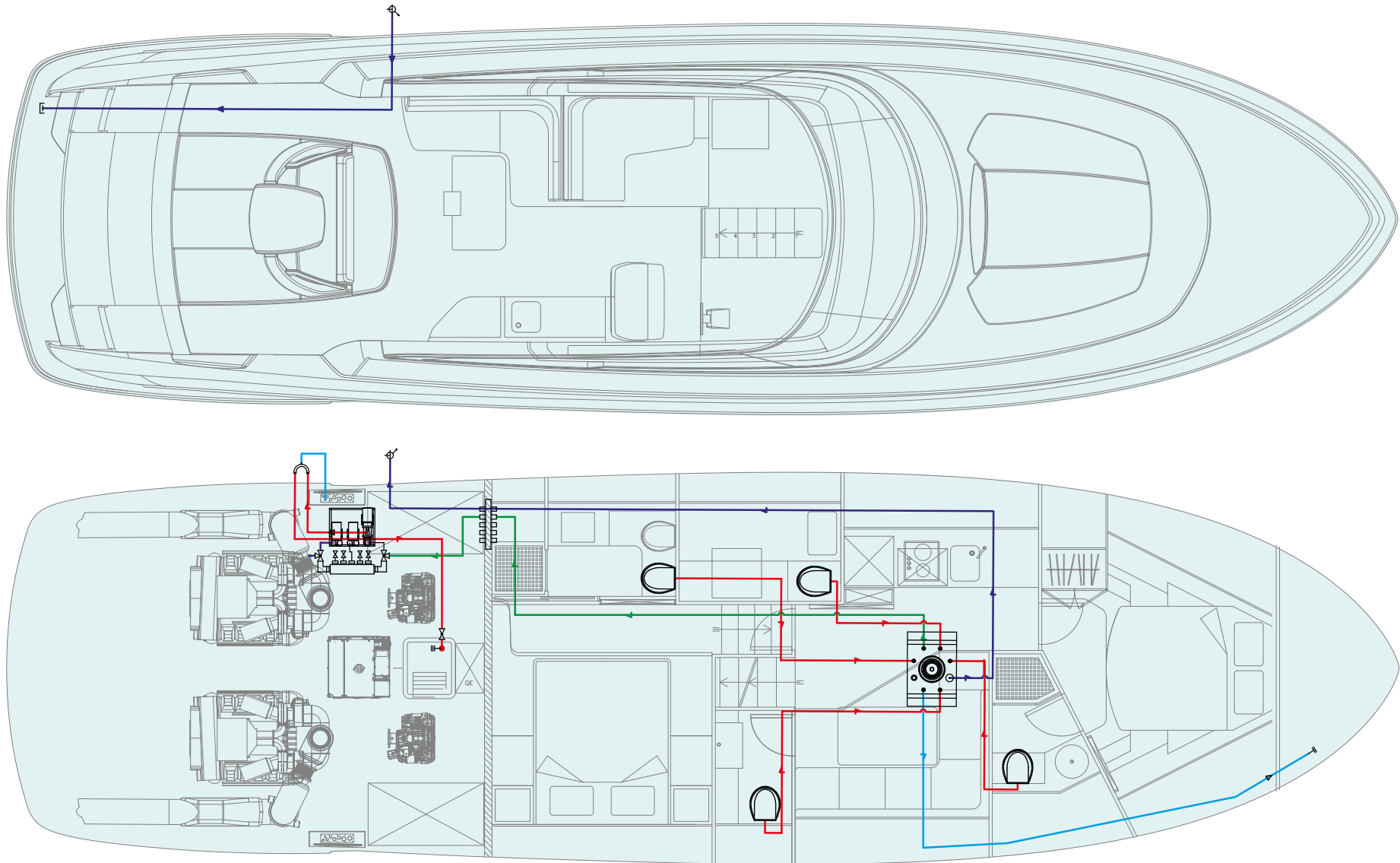

When using chemical products, follow the manufacturer indications meticulously and use the suitable protection devices.

**DANGER**

Holding tank washing must be performed by experienced personnel and followed carefully until the tank is empty.
An excessive pump operation can cause the intake of a large quantity of water with consequent overfilling and bilge flooding.

Black water system diagram:



ICONA ICON	DESCRIZIONE DESCRIPTION
	Linea di scarico Discharge line
	Scarico cassa di banchina Dock discharge
	Linea di ventilazione Vent line
	Linea di ventilazione Vent line
	Linea ausiliaria Auxiliary line
	Valvola a sfera Ball valve
	Valvola a sfera a tre vie 3 way ball valve
	Tubo che sale Pipe going up
	Tubo che scende Pipe going down
	Sfiato aria Air vent

ICONA ICON	DESCRIZIONE DESCRIPTION
	Bocchetta di scarico Discharge nozzle
	Curva di sfogo Vent curve
	Tappo di scarico Discharge cap
	Collettore quattro vie 4 way manifold
	Passaparatia Bulkhead
	Serbatoio raccolte acque nere Black water collection tank
	Elettropompa Electropump
	Filtro antiodori Anti-odor filter
	Collettore di scarico a murata centralizzato Centralized side exhaust manifold

5.3.1 Operation of the toilet

The bathroom toilets are made of ceramic and their control panels contain two backlit buttons:

- Button “BEFORE USE”;
- Button “AFTER USE”.

After 2 minutes of service the backlit buttons 1 and 2 switch OFF and the device sets to energy saving mode.

Approaching the hand to the panel, the backlight will be restored and the operation panel.

In case of alarm for a full tank, the two button icons are illuminated permanently.

To clean the surface of the panel, you can turn it OFF by pressing briefly one of the two buttons.

This prevents the accidental activation of the toilet control.



CAUTION

We suggest not to use the **residential function** of the toilet, as the water inside the toilet could splash out and wet the floor due to the yacht's rolling.



CAUTION

Except for organic waste, only very thin toilet paper can be discharged into the sea toilets. Paper tissues or handkerchiefs and sanitary napkins may clog and damage the sanitary system.



CAUTION

Make sure that toilets are electrically powered and that the black water system is operating before using them.



CAUTION

Forcing the toilet discharge can cause overflow of the tank.



CAUTION

The full tank condition is indicated by the red light of the tank indicator on the main electrical panel.





CAUTION

The disabling of toilet drain protection can cause the tank to overflow.

NOTE

For further information on use and maintenance, please refer to the manufacturer's manual.

5.3.2 Maintenance of black and grey waters draining system

Component	Maintenance	Notes and precautions
Black and grey water tank	Rinse the tanks (at least every month)	<p>Have the tanks filled with clean water and drain them two or three times. To prevent the formation of bacteria and of bad smell, pour periodically a disinfectant into the toilet, sink and bidet drains.</p> <div style="border: 1px solid yellow; padding: 10px; margin: 10px 0;"> <p style="text-align: center;"> CAUTION</p> <p>Should deodorants or disinfectants be used, avoid abrasive substances or acids, because they could damage tubes and seals.</p> </div> <div style="border: 1px solid yellow; padding: 10px; margin: 10px 0;"> <p style="text-align: center;"> CAUTION</p> <p>In case of need, break or pollution of the tanks, they can be replaced. Contact the RIVA After Sales & Service Department.</p> </div> <div style="border: 1px solid gray; padding: 10px; margin: 10px 0;"> <p style="text-align: center;">MAINTENANCE</p> <p>At least once a week check the correct operation:</p> <ul style="list-style-type: none"> • Of toilets; • Of the black/grey water pump. <p>At least once every three months check the status of the tubes and connections.</p> <p>At least once every six months protect with proper products:</p> <ul style="list-style-type: none"> • Of Toilets solenoid valves; • The black/grey water pump. <p>When necessary, at least once a year, carry out the accurate cleaning of the holding tank.</p> </div>

Component	Maintenance	Notes and precautions
Pumps	Replacement of impeller and mechanical seal	<p>This is a complex operation and should only be undertaken by skilled personnel.</p> <div style="border: 2px solid yellow; padding: 10px; text-align: center;">  <p>CAUTION</p> <p>The electric motor may become hot when running (see manual of the electric pumps). Pay attention. The electric pump must only be repaired by competent or qualified personnel, using manufacturer's spares; if this procedure is not followed, the manufacturer is relieved of any responsibility and warranty is void and null.</p> </div>

Component	Maintenance	Notes and precautions
Pumps	Operation check and cleaning (at least every month)	<p>Electric pumps usually do not need ordinary maintenance, as long as some precautions are taken, which extend their lives (address to the pumps' Manufacturer).</p> <div style="border: 2px solid red; padding: 10px; text-align: center;">  <p>DANGER</p> <p>Before each intervention make sure that voltage is disconnected and that there is no possibility of accidental connection.</p> </div> <ul style="list-style-type: none"> • If there is a risk of freezing, it is necessary to empty the pump casing from the liquid and to fill it, before restarting the pump. • Make sure that the pump never runs dry. • The DC motor brushes must be periodically checked for consumption and spring pressure. • If the pump does not work for a long time, it is better to empty the pump casing and clean it. • If a strainer and a foot valve are installed, check periodically for their efficiency and cleaning. • Check that the impeller is jammed, this could cause heavy damages to the electric motor; if this happens, descale the impeller and pump body. • At least once a month, have the operation of the grey/black water pumps checked, having their tanks filled with clean water until the pump activates and having the correct overboard draining checked.

5.4 SCUPPERS SYSTEM

The scupper system, by means of suitable holes and drainage channels, allows rainwater, seawater or other water that may fall onto the main deck to flow quickly off the yacht.

All waters collected by the scuppers are conveyed by means of manifold tubes, placed along the bulwarks.

The total or partial clogging of one or of more scuppers must absolutely be prevented, because it is a cause of flooding and consequent loss of stability by the yacht and its structures.



CAUTION

Always check the correct water flow towards the scuppers.
The partial or total clogging of one or more scuppers is a possible cause of damage for the yacht structure and of loss of stability.



CAUTION

Avoid that incorrectly stowed objects clog the scuppers.

Scuppers system diagram:

DA RICEVERE IMPIANTO SPECIFICO
R56 RIVALE SUPER

NON RICEVUTO PER R56 RIVALE

5.5 BILGE SYSTEM

5.5.1 Main bilge system

The centrifugal diving pumps for bilge suction, driven by suitable float switches, suck water from the bilge and deliver it to the outboard exhausts positioned at the side.

Another float for alarm activation, located a little higher than the first one, actuates the acoustic alarm in the stern cockpit.

The pumps are connected directly to the batteries and can therefore start even if the battery master switch is positioned to OFF, thus ensuring water drain at any time (keep the magneto-thermal breakers on the electrical panel to ON).

The suctions of the pumps are equipped with strainers; their purpose is to prevent the penetration inside the circuit of foreign bodies, which may damage the pump or cause pipe clogging.

- Engine room bilge pumps (230 l/min) [61 gal/min];
- Midship bilge pump (230 l/min) [61 gal/min].

The bilge pumps can operate both in automatic mode, thanks to float switches and in manual mode.

To activate the pump manually it is necessary to activate the relevant buttons located on the synoptic panel in the helm station. To enable the running of the bilge pumps, switch on the relevant thermal breakers located on the main electrical panel.



WARNING

In case of emergency it is possible to extract the bilge water in the engine room through the sea pumps placed on each engine.



WARNING

Keep the bilge dry to allow the detection of water and to reduce the risk of slipping, as well as creating a less aggressive environment for the fixtures.

Should the automatic bilge pumps of the engine room, as well as the auxiliary bilge pump not be able to drain the bilge water, the engine room is equipped with the bilge emergency draining system, operating by means of flywheel valves with manual activation, as a draining pump.

In case of emergency, use the handwheels of both valves, taking the valves to the emergency position; the suction of the pumps, driven by the engines, is diverted towards the bilge.

Should it be necessary to use this draining system, the bilge level must be checked continuously, because in case of complete drainage, the engines will not be cooled down.



CAUTION

Be careful to replace the valves to sea water suction position, when the water level in the engine room bilge is under control, so as not to impair the engines components.



CAUTION

A suction basket to collect accidental oil leakage is located under the engines and does not communicate with the bilge.

**CAUTION**

In case of water presence in some compartments of the lower deck, before getting alert, check if the bilge water is fresh or salted, this will be of fundamental help with checking its source.

**WARNING**

The bilges must be kept dry and clean.
Remove any rags or other residues from the bilge, to prevent any clogging of the pump intakes, causing serious damage to the pumps and impairing the safety of the yacht.

**WARNING**

The system total capacity is not designed for yacht draining in case of a hull leaks.

**ENVIRONMENT**

Possible oil or fuel spilled in the bilge must be collected and stowed.
It is forbidden to discharge bilge water mixed with oil or diesel fuel into the sea, because this can cause pollution.
During the maintenance operation in the engine room, it is compulsory to disconnect the magneto-thermal breakers of the bilge pump automatic suction system, avoiding in this way accidental spillages of liquids and consequently sea water pollution.

Bilge draining system diagram:

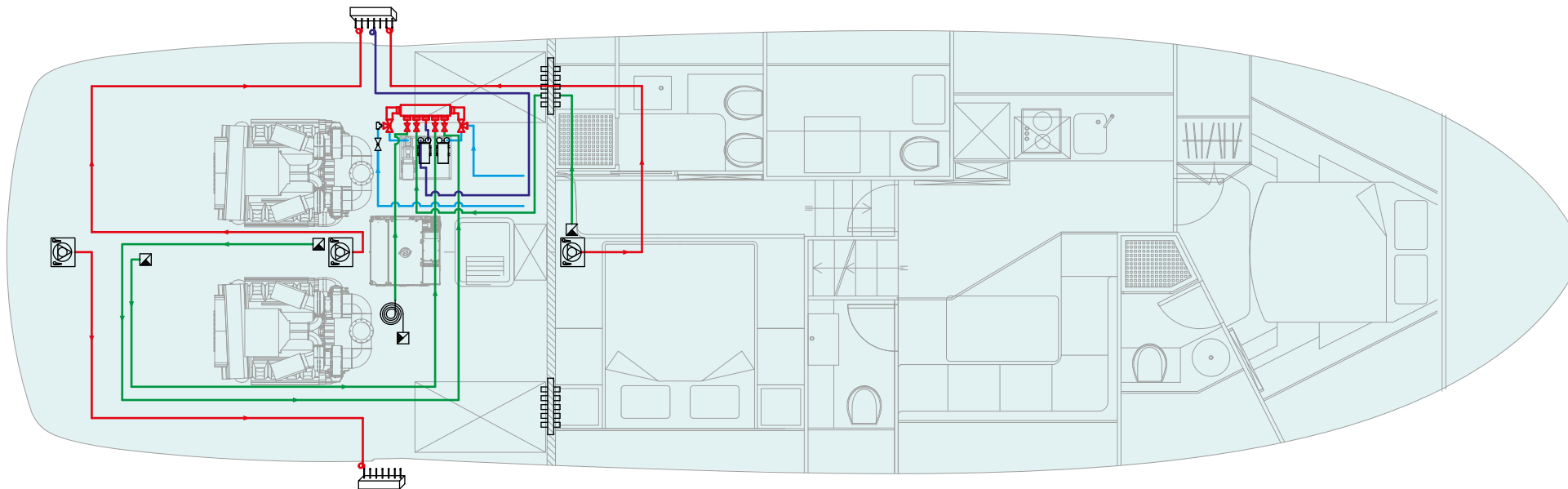

ICONA ICON	DESCRIZIONE DESCRIPTION
	Linea di sentina EL/P EL/P bilge line
	Linea di aspirazione sentina ausiliaria Auxiliary bilge suction line
	Linea di mandata sentina polivalente Multi-purpose bilge delivery line
	Linea scarichi vari/polivalente Various/multi-purpose discharge line
	Valvola di sicurezza a doppia aspirazione Double suction safety valve

ICONA ICON	DESCRIZIONE DESCRIPTION
	Valvola di fondo Foot valve
	Collettore di scarico Discharge manifold
	Passaparatia Bulkhead
	Elettropompa a immersione Submersible electric pump
	Filtro a gabbia per pompe a immersione Cage filter for submersible pumps

ICONA ICON	DESCRIZIONE DESCRIPTION
	Pigna di sentina Bilge strainer
	Elettropompa di scarico polivalente Multi-purpose electric drain pump
	Galleggiante allarme sentina Floating bilge alarm
	Galleggiante azionamento pompa Floating pump actuation
	Sentina volante Flying bilge

5.5.2 Maintenance on the main bilge system

Component	Maintenance	Notes and precautions
Bilge pumps	Operation check Bilge pump operation check	As shown in the following sequence.
Non-return valves	Operation check	As shown in the following sequence.

Bilge pumps functionality check:



DANGER

Before each intervention make sure that voltage is disconnected and that there is no possibility of accidental connection.

Check that the pump shaft turns freely (this is possible by inserting the screwdriver in the back end of the engine shaft).

Check the rotation direction, that the pump motor works within its output range and that the absorbed current is not higher than the one indicated in the tag.

These pumps, normally, do not need ordinary maintenance, provided that some measures are taken which extend their operation.

- Make sure that the pump never runs dry.
- The brushes, on DC motors, must be checked at regular intervals.
- If the yacht must remain inoperative for a long period, it is advisable to drain the pump body and to clean it.
- If a strainer and a foot valve are installed, check their efficiency and cleaning periodically.

- Check that the impeller is not jammed, this could cause serious damages to the electric motor; if this happens, descale the impeller and pump body.
- Have the operation of each bilge pump checked, having the bilge filled with clean water up to the activation of each pump and having the correct draining overboard checked.
- Have the operation of each bilge pump checked also manually.



CAUTION

Never run the electric pumps dry.



CAUTION

Check the operation of all bilge pumps at regular intervals. Clean debris from pump inlets.

Non-return valves

The on-board hydraulic system consists of check valves (or non-return valves) "EUROPE" type (1) and "CLAPET" type (2).

They require extraordinary maintenance only, due to their lack of operation, which can be caused by a foreign body inside the valve itself, or by a mechanical break; in both cases, check the failure, if it is not removable, carry out the replacement.



5.5.3 Centralised pump system

The yacht is equipped with a multi-purpose pump 90 l/min (24 gal/min), which can be used, in case of emergency, to help or to replace the various automatic bilge pumps, in order to drain water from the bilge.

The multi- purpose pump, activated manually, by correctly shunting the valves on the relevant manifold, can replace the following pumps:

- The black water pump;
- The grey water pump;
- The automatic bilge pumps.

In case of failure of black or grey water pumps, the multi-purpose pump replaces the suction of one of the two pumps, by means of two deflecting valves installed on the multi-purpose pump manifold.



CAUTION

After the use of the multi-purpose pump, it is advisable to carry out a check of the impeller. For the procedure ask RIVA After Sales & Service Department.



CAUTION

To use the multi-purpose pump, activate the magneto-thermal located on the main electrical panel.



CAUTION

Never run the electric pumps dry.



ENVIRONMENT

The bilge drains can be discharged at sea only if they do not contain polluting substances.

If polluting agents are present in the bilge waters, dispose of them using the suitable containers for polluting agents located in harbours.

5.6 SEA WATER SYSTEMS

The sea water systems on board are:

- **Engine cooling system**
This consists of two circuits, one for the starboard engine and one for the port engine. Sea water is sucked directly by the inner pumps of the same engines, by means of two sea cocks equipped with two cut-OFF valves and strainers. The water sucked in by the engines flows through the strainers and is then delivered to the heat exchangers of the gear boxes and to the heat exchangers of the same engines, and then discharged overboard. Moreover, suitable circuit branches cool the exhaust manifolds.
- **Generator cooling system**
Seawater is sucked in by the generator pump through the seawater intake equipped with a shut-OFF valve and strainer. The water sucked in by the generator, after passing through the strainer, is sent to the generator heat exchanger and then discharged overboard. To discharge water and exhaust fumes outboard, the generator channels the discharge through a muffler and then to a separator.
- **Fire extinguishing system**
This consists of an electric pump that sucks in seawater through a seawater intake fitted with a shut-off valve and strainer and sends it to the fire hose.
- **Air-conditioning unit cooling system**
This circuit consists of a seawater intake with shut-OFF valve, an inspectable seawater strainer and a connection for distribution to the air-conditioning unit.

- **Gyroscopic stabilizer cooling system**
Seawater is sucked in by the pump used to cool the stabiliser via a seawater intake equipped with a shut-OFF valve and strainer. The suctioned water, after passing through the strainer, is sent to the stabiliser heat exchanger and then discharged outboard.
- **Watermaker unit supply system (optional)**
This circuit consists of a seawater intake with shut-OFF valve, an inspectable seawater strainer and a connection for distribution to the watermaker unit.
- **Propeller shaft seal cooling system**
This circuit consists of a seawater intake with shut-OFF valve, an inspectable seawater strainer and a connection for distribution to the propeller shaft seals.



CAUTION

Before cleaning the seacock strainers, check that any uses supplied with seawater are switched OFF and not in use.



WARNING

It is good practice to close all sea cocks when leaving the yacht in the water for a long time.



CAUTION

In case of sinking hazard, if the escaping conditions allow it, close all ball valves of the sea intakes.

**DANGER**







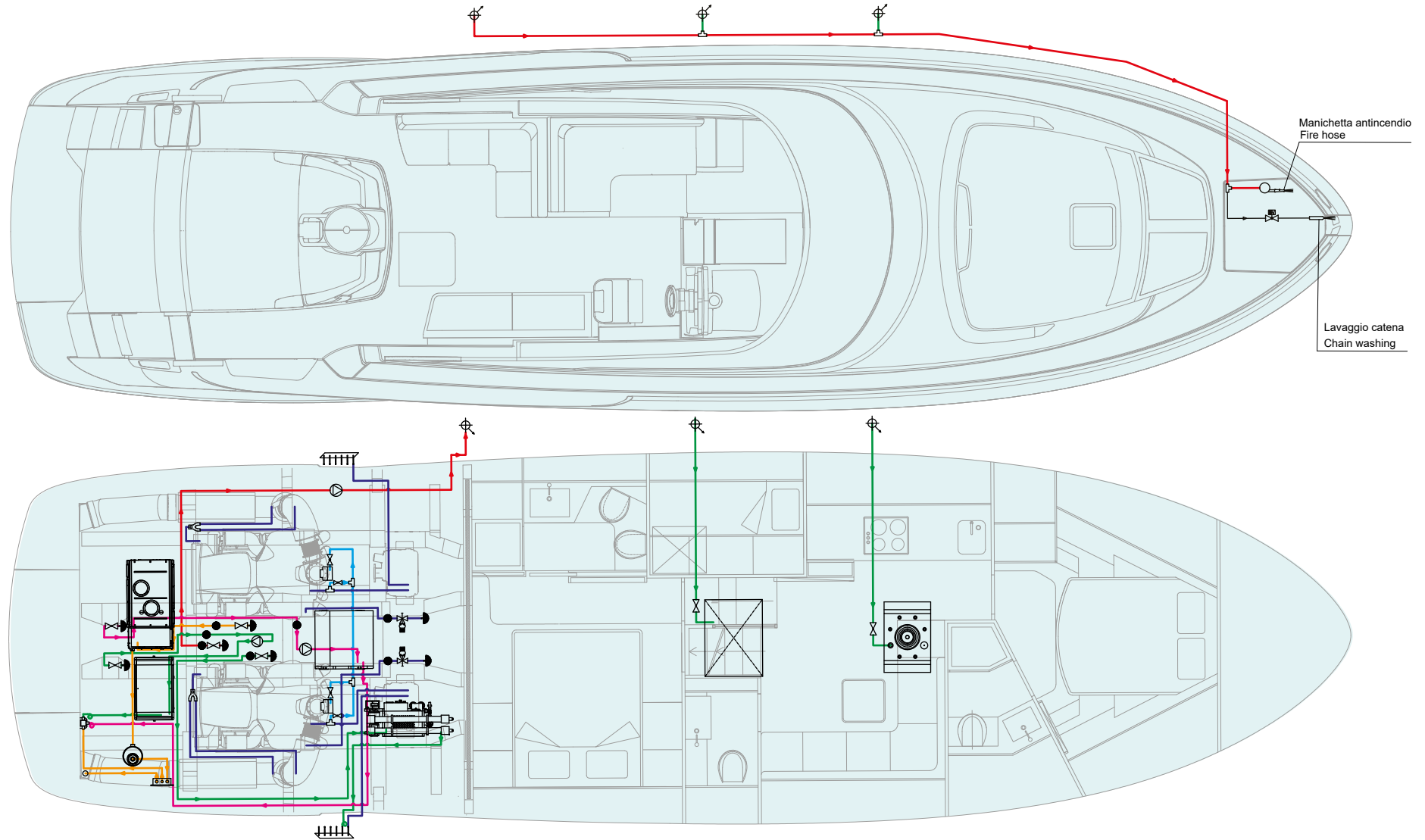

The lack of care while cleaning each sea intake strainer can cause serious damage to the on-board devices and, in some cases such as fire, it may have extremely serious consequences. Check before undertaking the navigation and at regular intervals during navigation, the condition of the sea cock strainers of the various devices through the transparent cover.







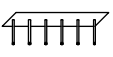

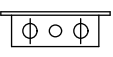
**WARNING**

It is good practice to close all seacocks when leaving the yacht in the water for a long period of time.

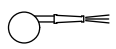
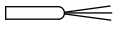

Sea water distribution system:







ICONA ICON	DESCRIZIONE DESCRIPTION
	Valvola a sfera Ball valve
	Elettropompa per acqua di mare Sea water electropump
	Valvola presa mare filettata Threaded sea water intake valve
	Filtro Strainer
	Presa a mare Sea cock
	Scarico immerso centralizzato Centralized submerged discharge
	Scarico a murata centralizzato Centralized wall discharge
	Valvola di fondo Foot valve
	Silenziatore Muffler
	Separatore acqua gas Water gas separator

ICONA ICON	DESCRIZIONE DESCRIPTION
	Elettrovalvola di lavaggio catena Chain washing solenoid valve
	Unità principale aria condizionata Air conditioning main unit
	Unità principale aria condizionata Air conditioning main unit
	Manichetta antincendio Fire hose
	Lavaggio catena Chain washing
	Linea mare motori Engines sea water line
	Linea mare generatore Generator sea water line
	Linea mare stabilizzatore giroscopico Gyroscopic stabilizer sea water line
	Linea mare servizi / A/C A/C services sea water line
	Linea mare antincendio Fire-fighting sea water line

5.6.1 Maintenance of sea cocks and strainers

Component	Maintenance	Notes and precautions
Seacocks and strainers	Cleaning (as required depending on the shoring area, but at least every month)	<p>Seacock cleaning This operation has to be carried out outside, therefore the yacht must be in a dry shore or you can ask the intervention of a diver.</p> <ul style="list-style-type: none"> • Have the sea cocks cleaned (removal of seaweed or barnacles. If necessary have them removed with a brush). <div data-bbox="1072 544 2074 735" style="border: 2px solid red; padding: 10px; margin: 10px 0;">  <p>DANGER</p> <p>When the yacht is in the water, disable start-up of the engines, generator and seawater pumps before working on the shaft lines.</p> </div> <p>Inspection and cleaning valves and strainers:</p> <ul style="list-style-type: none"> • Cleaning is to be carried out more frequently if the water drawn in is particularly dirty (seaweed, mucilage, etc..). <div data-bbox="1072 922 2074 1114" style="border: 2px solid orange; padding: 10px; margin: 10px 0;">  <p>WARNING</p> <p>Before removing the strainer, it is necessary to close the valve fitted to the sea cock, to prevent flooding the bilge with water.</p> </div>

Component	Maintenance	Notes and precautions
Seacocks and strainers	Cleaning (as required depending on the shoring area, but at least every month)	<p>Inspection and cleaning valves and strainers:</p> <ul style="list-style-type: none"> • Check for barnacles or corrosion on the control levers of the cut-OFF valves of the strainer to be checked. • Clean the control levers of the valves with a brush. • Move the levers repeatedly. • Close the cut-off valve upstream the strainer. • Remove the strainer cover by loosening the screws. • Remove the filter element, clean it with a brush and rinse it in water (replace as necessary). • Clean the strainer housing. • Check and, if necessary, replace the gasket of the strainer cover. • Fill the strainer with water to avoid the pumps running dry or that the system does not prime. • Reposition the strainer, the cover and tighten the nuts. • Reopen the cut-off valve and check whether the strainer cover is leaking. <div style="border: 1px solid orange; padding: 10px; margin-top: 10px;"> <p style="text-align: center;"> WARNING</p> <p>Before servicing the sea water lines, disable the operation of the connected utilities. Before restarting the utilities, make sure that the cut-OFF valve is completely open.</p> </div> <div style="border: 1px solid orange; padding: 10px; margin-top: 10px;"> <p style="text-align: center;"> WARNING</p> <p>During navigation, regularly check the cleanliness of the sea water strainer baskets. If the yacht is crossing a dirty sea area, check the condition of the strainers and proceed with their cleaning. Taking suitable precautions is very important to prevent damage to mechanical parts (engines, generator, etc.), discharge systems and to not jeopardize the safety of the yacht.</p> </div>

Component	Maintenance	Notes and precautions
Utility electric pump	Cleaning and checks	<p>At least each week, check the operation of the sea water pump.</p> <div data-bbox="1075 327 2072 694" style="border: 2px solid orange; padding: 10px;"> <p style="text-align: center;"> WARNING</p> <p>The pump is self-priming but, in order to operate, it needs to have its body filled with liquid. For a correct use, we recommend at first priming or after a long idling period, to fill the pump body with liquid and to verify the rotation direction of the pump (it should be clockwise, seen from the engine side). Besides, if on the control panel the pump operating led remains always lit, but the connected utilities are not in use, check for leaks.</p> </div> <div data-bbox="1075 742 2072 893" style="border: 2px solid red; padding: 10px;"> <p style="text-align: center;"> DANGER</p> <p>Before servicing the pump, disable its operation.</p> </div> <ul style="list-style-type: none"> • Have the inner cleanliness of the pump checked; possibly, have it cleaned with well diluted detergent and dried. • Have the fittings for well tightening and corrosion checked. • Frequently check and keep the suction filter clean. • Check that the electric power supply cables are in good conditions. <div data-bbox="1075 1157 2072 1276" style="border: 2px solid gray; padding: 10px;"> <p style="text-align: center;">NOTE</p> <p>For further information on use and maintenance, please refer to the manufacturer's manual.</p> </div>

Seacocks, strainers and valves:

The sea cock cleaning operation must be carried out from the outside, therefore with the yacht dry or with the intervention of a diver.

- Have the sea cocks checked for cleanliness (absence of algae or encrustations). If necessary, have them cleaned with a brush).

**DANGER**

If the yacht is in water, before working on the shaft lines, inhibit the starting of the engines, generator and sea water pumps.

- Check that there are no deposits or corrosion on the shut-OFF valve control levers of the strainer to be checked.
- Clean the valve control levers with a brush.
- Operate the levers repeatedly.
- Close the shut-OFF valve upstream of the strainer.
- Remove the strainer cover by loosening the screws.
- Remove the filter element, clean it with a brush and rinse it with water.
- Clean the strainer container.
- Check and, if necessary, replace the strainer cover gasket.
- Fill the strainer with water to prevent the pumps from running dry or the system from starting up.

- Replace the strainer, cover and tighten the bolts.
- Reopen the shut-OFF valve and check for leaks from the strainer cover.

**CAUTION**

Before reactivating the system, ensure that the shut-off valve is open.

**DANGER**

Before working on the sea water lines, inhibit the operation of the fed systems.

Riva

56 RIVALE *supera*

ELECTRIC SYSTEM

CHAPTER 6

6.1 ELECTRIC SYSTEM

The electric system of the yacht has been designed paying the utmost attention to all aspects regarding your SAFETY and the SAFETY of your Guests and it has been manufactured using high-quality materials, fully in compliance with the rules in force.

The electric system of your yacht consists of three defined and separated sections.

- Service electrical system powered by a nominal voltage of 24 VDC supplied by four series-connected 12 VDC - 180 Ah storage batteries. This battery bank is recharged by the battery charger and the alternator of one of the two propulsion engines.
- Engine electrical system powered by a nominal 24 Vdc supply provided by four parallel-connected 12 VDC - 180 Ah batteries. This battery bank is recharged by the battery charger (second output) and by the alternator of one of the propulsion engines. One engine charges the service bank and the other charges the engine bank, so that both battery banks are guaranteed to be charged while cruising.
- 230 V uses electrical system powered by shore power or alternatively by the on board generator. Each generator unit is powered by a 12 VDC - 180 Ah battery located near the generator and is recharged by an alternator driven by the unit itself.

The yachts are equipped with electronic injection machines and electronic remote control systems. For this reason it is very important for the user to carry out some simple operation to prevent faults to the electric systems, which on their turn may cause problems to the propulsion system.



CAUTION

Before undertaking any navigation, check that the batteries are in good condition and that they supply the correct nominal current.



CAUTION

During navigation both the button switch of the service batteries and the button switch of the engine batteries must always be connected, that is positioned to ON. The parallel button switch on the two sets must be normally disconnected and therefore set to OFF.



CAUTION

If during navigation an operation fault on the re-charging alternators occurs, set to "ON" the button switch of the parallel connection between the batteries sets and leave it connected until the fault has been removed.



CAUTION

Never start navigation without having set to ON both the engines batteries switch and the services batteries switch and do not disconnect them during navigation.

**CAUTION**

The engine control systems: accelerator and gears engagement remote controls are electronic. Their reliability is very high, but in case of a sudden black-out, it is necessary to immediately switch OFF the engine which is not controllable any more by means of the relevant buttons located in the helm station.

**CAUTION**

Disconnect the shore power supply connections when the system is not in use.

**CAUTION**

Use electric devices with double isolation or grounding.

**CAUTION**

When the engines are switched ON, the engine and service battery chargers are automatically switched OFF to prevent them from working in parallel with the engine charging alternators.

**WARNING**

Do not allow the cable end of shore power supply to float in the water. This can cause an electric field and following injuries or even the death of the swimmers nearby.

**CAUTION**

Do not modify connectors of shore power supply cable, use only plug compatible connectors.

**WARNING**

Before stopping the power generator, disconnect the various on-board services supplied by this; stopping the power generator under load can irreparably damage the electronic control units of the various uses and have a negative influence on the generator operation.

The on board electrical system has been designed and installed in compliance with UNI EN ISO and RINA standards, applying the following criteria:

- All wiring, joints and line-feed protection devices such as magneto-thermal breakers, and fuses have been collected and grouped both within and on the front panels of the various on board electrical panels.
- All electrical lines are oversized, ducted and/or inspectable and implemented with flame-retardant cables laid inside special self-extinguishing conduit; all the aforesaid lines are connected with special spring-type terminal blocks, the latter positioned inside the engine room main electrical panel and in the various electrical sub-panels.
- The system is highly fragmented into sub-circuits and protected with magneto thermal breakers and fuses for each single load or homogeneous load groups in order to simplify the tracing of possible faults which, for any line, can only occur at the load and the electrical panel.

The protection of the single electric system sections is performed by automatic magneto-thermal breakers of different amperage and size, according to the absorption of the various services to be protected and by the size of cables used for their supply.

All metallic wet pieces are interlocked with equipotential connections and linked on sacrificial anodes installed on the underwater quick-work.



WARNING

Refrain from performing any modification or intervention on the system and on the panel and take advantage of experienced Companies and skilled staff. Avoid particularly derivations on electric lines and splices of services not provided for on the same panel. Finally, if you need to assign services to the switches available, make sure that their characteristics are suitable with the device installed.



NEVER:

- Work on the electric system while under voltage.
- Modifying the yacht's electrical system or related drawings: installation, modifications, and maintenance must be performed only by a qualified electrician.
- Alter or modify the intensity of rated current of protections against overcurrent.
- Install or replace electric equipment or devices with components exceeding the rated current intensity of the circuit.
- Leave the yacht unattended with the electrical system powered, except for the circuits of the bilge automatic suction pumps, of the fire-fighting protection and of the alarms.



DANGER

Electrocution hazard! Turn the power off before removing the cover and servicing any electrical equipment internal component.



DANGER

All electrical systems (included those at low voltage) if wrongly handled or subjected to overloads, can originate short-circuits and dangerous overheating with potential fire hazards!

**CAUTION**

If you are compelled to use the “battery parallel connection”, turn off all electronic devices, so as not to jeopardize their correct operation. In emergency conditions, use the battery parallel set for the shortest reasonable time.

**WARNING**

The services supplied by the inverter highly stress the batteries that could discharge as a result.

**DANGER**

We recommend, in order to operate in complete safety, to carefully read the safety rules relevant to the maintenance and contained in this manual.

**DANGER**

Before operating on the battery charger, disable the generator start and cut-OFF the shore power supply.

**DANGER**

When disconnecting the inverter by means of the switch located on the front panel, the connection with the mains is not broken OFF.

**WARNING**

Before carrying out the switching over of the AC sources (generator/shore), it is advisable to disconnect all AC services currently operating, to prevent damaging the electronic boards of the relevant devices.

**DANGER**

Do not work on the inverter or on its system if still connected to a current supply. Only qualified staff can carry out interventions on the electric system.

**CAUTION**

RIVA suggest to examine very carefully the whole documentation delivered by the manufacturers of the various components; and for any problem relevant to maintenance, to contact RIVA After Sales & Service Department directly.

**DANGER**

Before starting to work on electrical panels or devices, prevent the generators' operation by disconnecting the electric power supply from shore and the inverter.

**DANGER**

The system is similar to a domestic system in terms of features and risks and, if "wrongly" used, mishandled or serviced, it statistically represents one of the most frequent reasons for fire on board.

**DANGER**

Have the inner condition of the inverter and battery charger checked at least once a year by skilled personnel. Faults like loose connections, burnt wires, etc., with following risk of fire spreading, must be repaired immediately.

**WARNING**

Do not disconnect the battery master buttons with engines running or you may damage the engine alternators.

**CAUTION**

For the correct procedures of fuses replacement refer to the on-board electric manual delivered separately.

The on-board services are supplied by separate electric systems with different features:

- 24 V DC;
- 230 V AC (50 Hz).

6.1.1 Maintenance of the electric system

Component	Maintenance	Notes and precautions
Equipment and circuits	Cleaning and checks	At least once every six months, have the various connections of electric boards, panels and boxes checked by experienced personnel. Make sure that ground connections of electric equipment and electrical panels are tight and not oxidized. Have the absorption of the different electric motors periodically checked by skilled personnel. When cleaning the bottom hull, carefully clean the electronic instrument ground static discharger and the porous plate connected the power generator grounding. Moreover, check the condition of the protection anodes and if necessary, replace them. During the lay-up period, do not apply any antifouling on the ground static dischargers.\

MAINTENANCE

At least once a week check the operation of all electrical panels.

At least once every six months:

- Check the possible presence of damaged cables;
- Protect the various contacts.



DANGER

Before carrying out any intervention on the electric system, disconnect all circuits (shore, generator and inverter):

- Disconnect the shore sockets;
- Turn OFF the generator magneto-thermal switch;
- Set to OFF the magneto-thermal switches at inverter output and turn off the inverter (OFF button on the front).



DANGER

Do not modify the electric systems or relevant drawings. The installation, the modifications or the maintenance must be carried out only by a skilled naval electrician. Inspect the system at least once a year.



CAUTION

It is forbidden to use pressurized water on light appliances installed outside.

6.2 ELECTRICAL PANELS



CAUTION

Before removing the front panel for maintenance, stop the generator, disconnect the shore connections and the inverter.

NOTE

For a detailed description refer to the electric installation manual.

MAIN ELECTRICAL PANEL:

The electrical system is controlled from the electrical panel located on the access stairs to the lower deck.

The following main sections have been identified, in order to make the descriptions easier:

1. 230 V service magneto-thermal switches.
2. 230 V in-line ammeters and voltmeters, generator control and power switch.
3. Battery ammeters and voltmeters, alarm indicators, black and grey water control and saltwater and freshwater autoclave pump control.
4. 24V service magneto-thermal switches.



CAUTION

Always keep the safety systems and gangway powered. Operate the battery disconnect switch for safety systems and gangway only in the event of a short circuit or an emergency.

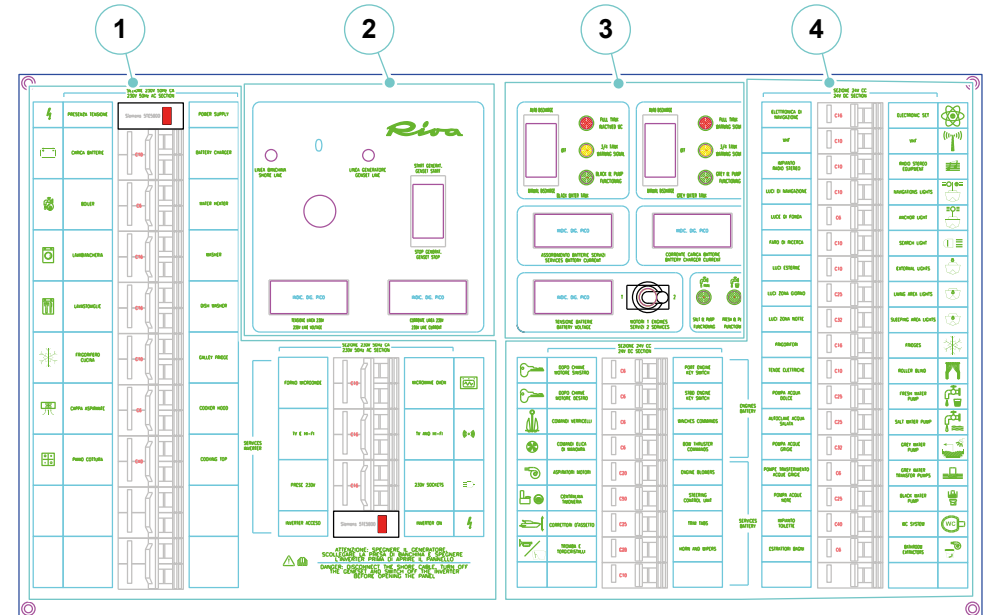

1. 230 V service magneto-thermal switches

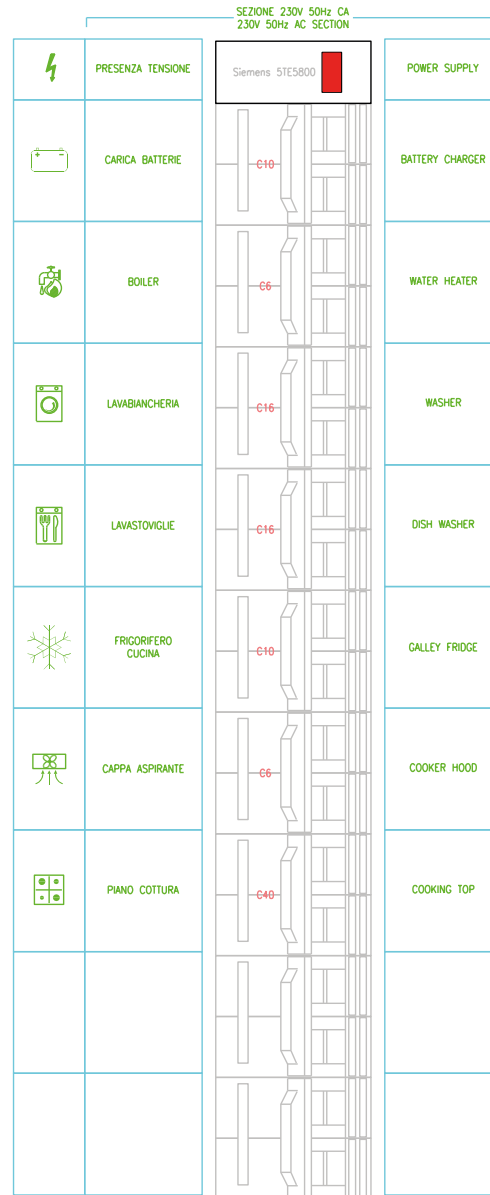

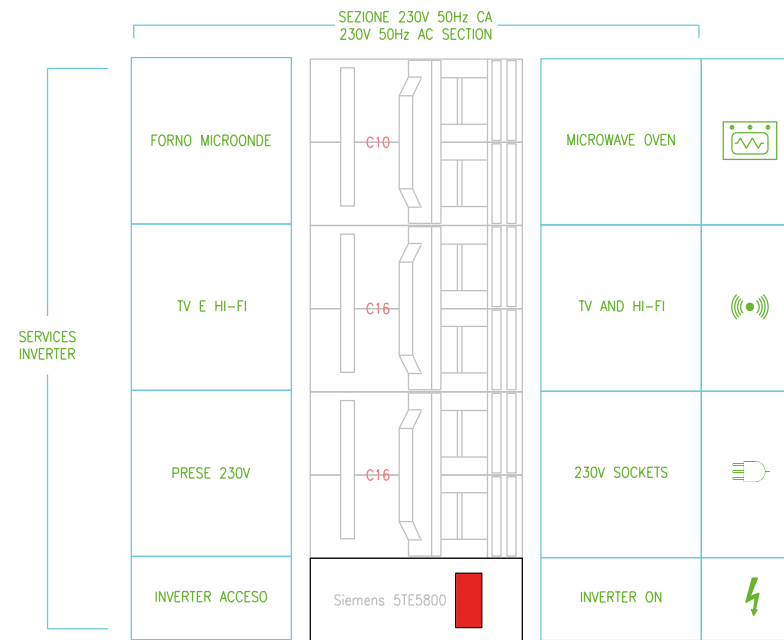

ATTENZIONE: SPEGNERE IL GENERATORE
SCOLLEGARE LA PRESA DI BANCHINA E SPEGNERE
L'INVERTER PRIMA DI APRIRE IL PANNELLO

DANGER: DISCONNECT THE SHORE CABLE, TURN OFF
THE GENSET AND SWITCH OFF THE INVERTER
BEFORE OPENING THE PANEL

2. 230 V in-line ammeters and voltmeters, generator control and power switch

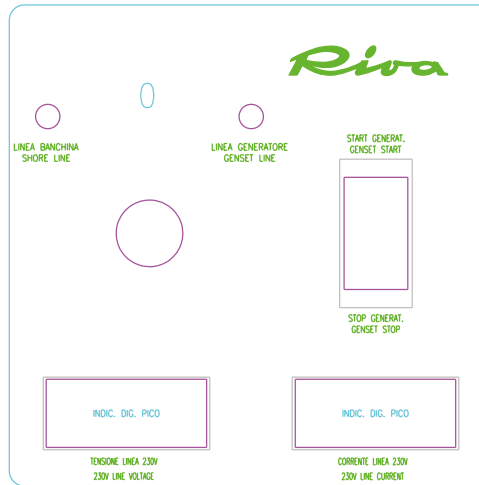

3. Battery ammeters and voltmeters, alarm indicators, black and grey water control and saltwater and freshwater autoclave pump control

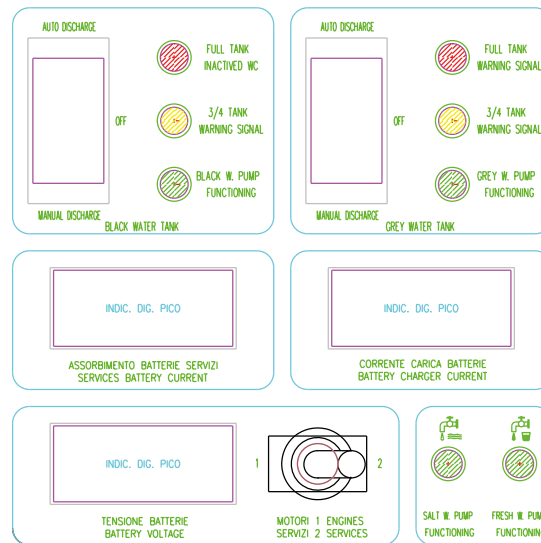

4. 24V service magneto-thermal switches

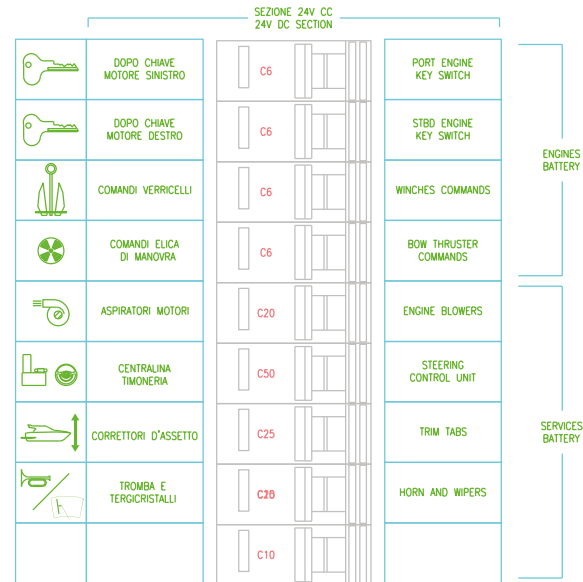

SEZIONE 24V CC 24V DC SECTION			
ELETTRONICA DI NAVIGAZIONE	C16		ELECTRONIC SET
VHF	C10		VHF
IMPIANTO RADIO STEREO	C10		RADIO STEREO EQUIPMENT
LUCI DI NAVIGAZIONE	C10		NAVIGATIONS LIGHTS
LUCE DI FONDA	C6		ANCHOR LIGHT
FARO DI RICERCA	C10		SEARCH LIGHT
LUCI ESTERNE	C10		EXTERNAL LIGHTS
LUCI ZONA GIORNO	C25		LIVING AREA LIGHTS
LUCI ZONA NOTTE	C32		SLEEPING AREA LIGHTS
FRIGORIFERI	C16		FRIDGES
TENDE ELETTRICHE	C10		ROLLER BLIND
POMPA ACQUA DOLCE	C25		FRESH WATER PUMP
AUTOCLAVE ACQUA SALATA	C25		SALT WATER PUMP
POMPA ACQUE GRIGIE	C32		GREY WATER PUMP
POMPE TRASFERIMENTO ACQUE GRIGIE	C6		GREY WATER TRANSFER PUMPS
POMPA ACQUE NERE	C25		BLACK WATER PUMP
IMPIANTO TOILETTE	C40		WC SYSTEM
ESTRATTORI BAGNI	C6		BATHROOM EXTRACTORS

Engine room electrical panels

These are located at the bow end of the engine room.
The following main sections have been identified, in order to make the descriptions easier:

1. 230V service magneto-thermal switches.
2. 230V service magneto-thermal switches.
3. 24V service magneto-thermal switches.

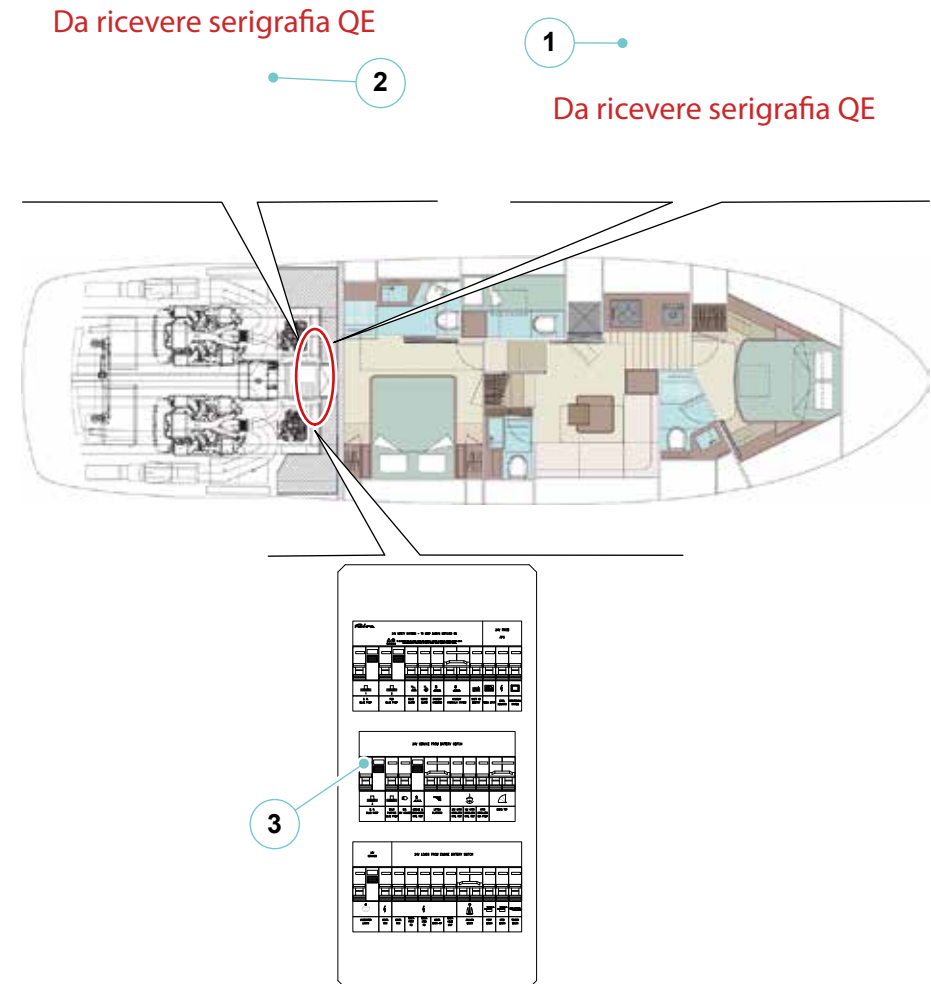

1. 230V service magneto-thermal switches











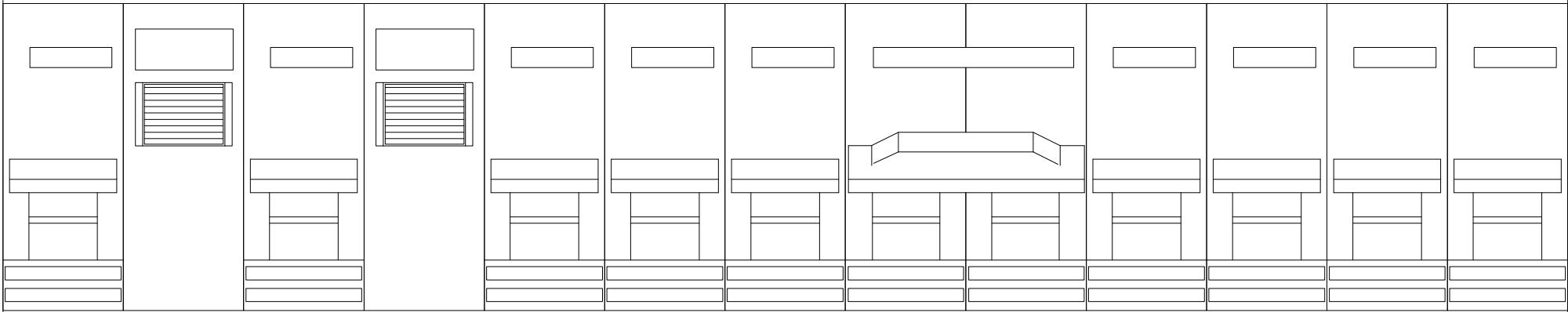
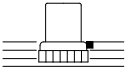
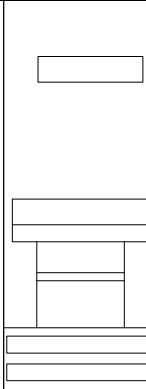
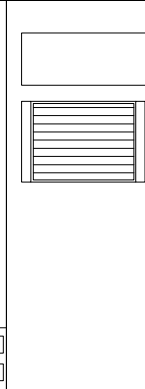
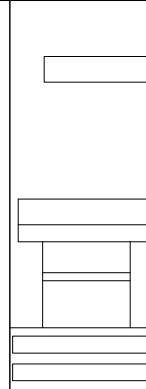

DA RICEVERE SERIGRAFIA QE
SPECIFICA R56 RIVALE SUPER

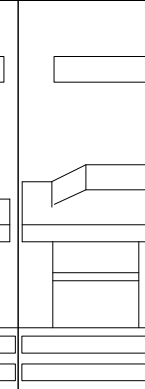
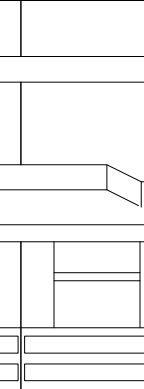
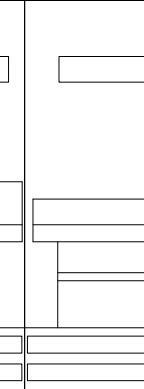
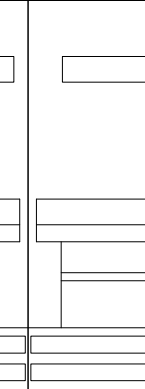
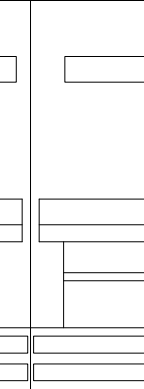
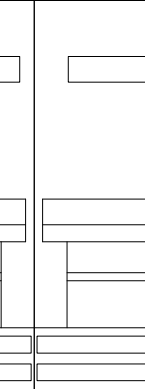
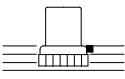
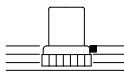
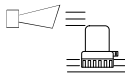
DA RICEVERE SERIGRAFIA QE
SPECIFICA R56 RIVALE SUPER

2. 230V service magneto-thermal switches

DA RICEVERE SERIGRAFIA QE
SPECIFICA R56 RIVALE SUPER

3. 24V service magneto-thermal switches

 <p>24V SAFETY SYSTEMS – TO KEEP ALWAYS SWITCHED ON</p> <p> WARNING TO DISCONNECT THE 24V SAFETY SYSTEMS AND HYDRAULIC GANGWAY IS INSTALLED A MANUAL BATTERY SWITCH IN ENGINE ROOM TO OPEN ONLY IN CASE OF SHORT CIRCUIT. REFER TO OWNER'S MANUAL</p>										<p>24V FROM APS</p>		
												
 1	 2											
E. R. BILGE PUMP	FWD BILGE PUMP	BILGE ALARM	SMOKE ALARM	GANGWAY COMMAND	GANGWAY HYDRAULIC SYSTEM	SINTO CD MEMORY	NMEA 2000	LEVEL SENSORS	MONITORING SYSTEM			

24V SERVICE FROM BATTERY SWITCH

<p>E. R. BILGE PUMP</p>		<p>MULTI PURPOSE BILGE PUMP</p>	<p>E.R. 24V SOCKET</p>	<p>GARAGE & SWIMLADDER CTRL UNIT</p>	<p>LIFTING PLATFORM</p>		<p>24V GYRO STABILIZER CTRL UNIT</p>	<p>12V GYRO STABILIZER CTRL UNIT</p>	<p>GYRO STABILIZER SEA PUMP</p>	<p>BIMINI TOP</p>

24V SERVICES		24V LOADS FROM ENGINE BATTERY SWITCH											
UNDEWATER LIGHTS	XENTA XCU	XENTA XCU	XENTA PORT RD	XENTA STBD RD	XENTA BACK-UP	XENTA HELM UNIT	ANCHOR WINCH	PORT WINCH	STBD WINCH	TENDER WINCH			

6.3 GROUND PROTECTION SYSTEM

On board there is an adequate grounding dispersion system fitted with a porous plate which constitutes the “means” of grounding the generator PE conductor, to which all the grounds of the alternating current systems are connected as well as all the negatives of the direct current systems.



DANGER

If the yacht is out of the water and connected to the shore power supply, check the presence of the shore-side system in the power supply system.



WARNING

Periodically check the status of sacrificial anode and porous plate: replace if the reduction for corrosion is more than 50% of their original mass. If their wearing is particularly quick, the on board electric system could be leaking. Have the electric system checked by experienced personnel.

6.4 BATTERY SET

The batteries are normally charged by the alternators during the operation of the engines. As an alternative, you can recharge them with the battery charger from shore or with the generator.

Description	Element number	Features element
Engine batteries	4	12 V 180 Ah
Generator batteries	1	12 V 180 Ah
Service batteries	4	12 V 180 Ah



WARNING

The batteries left unloaded over long periods of not operation, lose progressively their charge, until they become completely flat and get irreparably damaged.



CAUTION

Any replacement of the manoeuvring thruster battery bank must be carried out with sealed VRLA type batteries.



DANGER

NEVER obstruct the air intakes of the "battery boxes as natural ventilation must always be allowed so that the batteries do not overheat.



WARNING

Do not lay objects on the cases containing the batteries.



CAUTION

A frozen battery may blow up if used or charged; do not start a Yacht with frozen battery. To prevent the battery from freezing keep it always completely charged.



DANGER

The battery releases explosive gas: do not approach flames, sparkles or smoke near it. If the battery is used or charged in a closed area, ensure good ventilation. Do not check the battery charge by short-circuiting the terminals with metal tools: use a densimeter or a voltmeter.

6.4.1 Checking and maintaining batteries

Component	Maintenance	Notes and precautions
Batteries	Battery check (accumulators)	The batteries installed are low maintenance batteries, with no special control needs: It is recommended, however, to check the status at least twice a year and whenever there is a difficulty or delaying of charging time.



CAUTION

In case of contact with battery acid, wash the contaminated part with fresh water for at least 15 minutes and consult a doctor.



CAUTION

Remove bracelets, rings and every other piece of jewellery before working on the batteries.



WARNING

All maintenance operations listed must be performed only by skilled personnel.



CAUTION

Monitor the voltage of the engine and service batteries. During the charging phase 29.1V can be reached, this is a temporary value, well tolerated, both by the batteries and by the battery charger. This value must be monitored and, if this situation lasts for too long, the magneto-thermal breakers of the battery charger must be disconnected.



CAUTION

Always keep the batteries charged and recharge them periodically even if the yacht is left unattended. If the charge level drops to the minimum, the batteries can get irreparably damaged. Check the charge status each week.



WARNING

The battery replacement must always use the original model of battery originally furnished by the shipyard.

Carry out following checks:

Terminal inspection

- Check that the battery containers are clean and dry and that the terminals are coated with silicon grease and properly fastened. Clean and grease as required. Inspect at least every 6 months.
- Identify positive and negative cables, prior to connecting (connect the positive terminal first and then the negative, in order to avoid sparkles).



DANGER

Batteries may be subject to explosion hazard, with subsequent risks of serious personal injuries. Do not use open flames, smoke, cause sparks or use arc-welders in the area where batteries are located. Do not disconnect battery cables when the generator is running.

Battery acid may cause serious injuries. Wear safety goggles, gloves and protective clothing.

Do not wear any bracelet, ring or any other jewel when operating on batteries.

In case of contact with battery acid, wash the contaminated part with fresh water for at least 15 minutes and address to a doctor.



DANGER

Always remove the negative terminal (-) for grounding connection first and connect it last.



DANGER

Operations on batteries must be performed by qualified personnel.



CAUTION

Check the condition of the batteries, making sure there are no traces of electrolytic corrosion on the poles and connection terminals; if corrosion is detected, contact the RIVA After Sales & Service Department and replace the affected elements.

6.5 BATTERY BREAKER PANEL

The panel is located inside the starboard-side cabinet in the cockpit. The panel contains the control buttons for the electric battery disconnect switches (each with a green LED) which activate:

- Button to enable service battery buttons;
- Service batteries;
- Parallel connection between engine and service batteries;
- Engine batteries.

When the led are lit the batteries are operating, in order to disconnect them press again the buttons (LED OFF).

If the electrical battery-disconnect switches should fail, it is possible to use the services battery direct manual breaker installed on the forward engine room bulkhead electrical panel.

The manual generator battery cut-OFF switch is located in the engine room near the generator.



CAUTION

Do not disconnect the battery breaker switches with the engines running because the engine alternators might get damaged.



CAUTION

Use the “Services-engine parallel connection” breaker only if strictly necessary and disconnect it as soon as possible.

- **Service batteries breaker**
This switch allows cutting in or out the service battery set.

- **Service/engine battery parallel connection**
If the engine batteries are flat or not sufficiently charged, the battery main switch allows the parallel connection between service battery bank and the engine battery bank, to enable the start of the propulsion engines.



CAUTION

This connection must be activated only if the engine batteries are not sufficiently charged. The battery parallel connection switch, must be activated only with buttons connecting the service battery banks and the engine banks set to ON.

- **Engine batteries breaker**
This switch allows cutting in or out the engine battery set.
- **Generator battery cut-OFF switch**
Allows the generator to be engaged or disengaged.



DANGER

Keep the breaker of the battery-powered uses set to ON. Cut out only in case of maintenance.

- **Safety systems and gangway battery cut-OFF switches**
Allows the bilge pumps, alarms and gangway to be to engaged or disengaged.
- **Stern thruster battery cut-OFF switch**
Allows the stern thruster to be powered or not powered.
- **Bow thruster battery cut-OFF switch**
Allows the bow thruster to be powered or not powered.

6.6 BATTERY CHARGER

SERVICES AND ENGINES CHARGER

There is a fully automatic, high-performance service battery charger on board your yacht.

The charger features optimised charging technology to charge batteries quickly and safely while still supplying power to connected uses.

The charger is also protected against short circuits, overloads and high temperatures.

The front of the charger features LEDs, which indicate:

- Charger status.
- Battery charging status.
- System communication status (flashing when communication is active).

The charger can be turned OFF or on by pressing the **MODE** button on the front for 3 seconds.

NOTE

For further information on use and maintenance, please refer to the manufacturer's manual.

GENERATOR BATTERY CHARGER (OPTIONAL)

Your yacht is equipped with on board generator battery charger.

The charger allows you to convert a direct current (DC) voltage into another stabilised DC voltage, with full galvanic isolation between input and output.

The converter works automatically. Under normal conditions there is no need to take any specific action. Despite its low no-load power consumption, the converter should be disconnected from the battery when not in use to avoid discharging the battery.



CAUTION

Before starting the generator, turn OFF the generator battery charger via the magneto-thermal switch located in the main switchboard in the 24 V services section.

Keep the charger switched OFF while the generator is in operation.

NOTE

For further information on use and maintenance, please refer to the manufacturer's manual.

6.6.1 Checking and maintaining the battery charger

Component	Maintenance	Notes and precautions
Battery charger	Inspection Charge output	At least two or three times a year, have the connection of each wire checked by skilled personnel for looseness or oxidation. Keep the battery charger dry, clean and away from dust in order to ensure a good dissipation of heat. Periodically check the good condition of the cooling fan.



DANGER

Do not work on the battery charger or on the electric system if they are still connected to a current source. Disconnect the mains supply before connecting or disconnecting the battery. Modification to the electric system must be carried out exclusively by skilled personnel and only after the approval of RIVA.



DANGER

Have the inner condition of the battery charger checked by skilled staff at least once a year. Faults like loose connections, burnt wires, etc., with following risk of fire spreading, must be repaired immediately.



WARNING

If the engines are on, the alternators are charging the batteries; it is therefore advisable to keep the magneto-thermal of the battery charger to OFF, in order to avoid alternator damage.

MAINTENANCE

At least once a month check the correct operation of the battery charger.
At least once a month carry out the complete cleaning.
At least once every six months protect the contacts with proper products.



DANGER

Before operating on the battery charger, disable the generator start and cut-off the dock power supply.

This device can operate in a reliable and optimal way, only if following operations are performed:

- Check that all breakers and indicator lights are working, the wiring does not present any signs of cuts and all parts are clean and free from oxidation;
- Remove the casing and check that circuit boards are free from oxidation. If necessary, clean by using the detergent solution;
- Protect the electric contacts by using an appropriate product (DC4);
- Reinstall the casing after cleaning;
- Check at least once a year the connection of each cable (for loose connections, etc.);
- Keep the battery charger dry, clean and in a dedusted area to ensure a good dissipation of heat.

**WARNING**

All maintenance operations listed must be performed only by skilled personnel.

**DANGER**

NEVER clog the air inlets of the cases containing the batteries because natural ventilation of the batteries must always be ensured so that they do not overheat.

Charge output

For a good operation, batteries must not be discharged below 30-40% of their capacity, therefore, always start recharging them, when this charge level is reached.

The battery charger is equipped with a temperature sensor located close to the batteries. According to the temperature value detected, together with the value of residual capacity of the batteries, the charger automatically adjusts the charging voltage according to temperature, thus remarkably increasing battery life. Moreover, besides the thermal compensation, the battery charger can also compensate the voltage drop due to the dispersion of the connection cables. The battery charger is provided with an integrated warning light which activates in case certain adjustment values are exceeded.

**CAUTION**

Should the battery voltage drop under 18 V, the battery charger will supply a current corresponding to the 25% of the maximum one and the recharge time will consequently increase.

6.7 ELECTRIC POWER SUPPLY FROM SHORE



DANGER

Before connecting the shore socket, ensure the type of voltage and the sockets available, their integrity and the absolute absence of moisture on the wire, on the socket and on the plug.

With plug connected check that wire:

- Cannot get in traction as a result of tide variations, yacht movements, etc..;
- Cannot get crushed, etc..;
- Does not come into contact with water.



CAUTION

The connection must be performed under safety conditions with not powered connections and by paying attention to carry out a correct grounding.

The shore columns can supply different types of voltage, according to the harbour where you are moored; contact the Port Authority for the correct power supply of the column you are going to be connected.

In order to power the yacht's electrical system, which in turn ensures operation of the various on board systems, a 63 A - 50 Hz shoreside connector has been fitted astern.

By means of the main electrical panel, it is possible to check and monitor the electric parameters of the shore socket, allowing a clear and readable display of the values measured, this facilitates the prevention of possible faults and malfunctioning and increases the safety of navigation.

It occurs very often to find shore plugs with dimensions not compatible with those on the yacht; in this case it is necessary to contact the Port Authority and to get a new plug or an adapter.

Electric shore power supply connection procedure:

- On the engine room main electrical panel, open (OFF) the general magneto-thermal breakers of the on-board services;
- Open the switch protecting the shore power connector;
- On the shore power column, open the power switch;
- Connect the power cable to the shore power column;
- Connect the power cable to the yacht;
- Turn OFF the switch on the shore power column;
- Turn OFF the switch to protect the power supply to the yacht's shore socket;
- From the main electrical panel, select the shore power supply and monitor the voltage;
- Only if the voltage level is correct, close the magneto thermal breakers that feed the loads.



CAUTION

Do not modify connectors of shore power supply cable, use only plug compatible connectors. If the yacht power supply cable cannot be plugged into the shore socket, ask the Port Authority for an adapter. In any case, never use adapters cutting the mass conductor connection between the shore electrical system and the yacht electric system.

The use of these adapters can irreparably damage the electric devices.

**DANGER**

Do not leave shore power supply connected without people on board.

**DANGER**

Before carrying out any intervention on the electric system, disconnect all circuits and the shore connection.

**WARNING**

If the warning light on the main electrical panel is on this means that the electric socket for shore power supply is plugged.

**CAUTION**

Disconnect the shore power supply connection when the system is not in use.

**DANGER**

Do not allow that cable end of shore power supply to floats in the water. This can cause an electric field as well as injuries or even the death of the swimmers nearby.

**CAUTION**

To cut the electric power supply from shore:

- Disable the shore power supply on the main switchboard in the engine room.
- Turn OFF the protections on the shore column.
- First disconnect the power supply cable from the shore power supply source (shore column), then from the yacht.

MAINTENANCE

At least once every two weeks, have the various connections of electric boards, panels and boxes checked by experienced and equipped personnel. Make sure that ground connections of electric equipment and electrical panels are tight and not oxidized.

At least once a month check the status of the shore socket and eventually clean it.

**DANGER**

Risk of electric shock from leakage currents. Never swim in waters near harbours or marinas.

6.8 FUSES

In addition to these protections, there are common fuses with types and characteristics appropriate to the specific installation.

Please refer to the electric system user's manual for their location on board.

The main fuses on board have the following characteristics:

- 2 A
- 4 A
- 10 A
- 15 A
- 30 A
- 40 A
- 63 A
- 100 A
- 125 A
- 160 A
- 250 A



DANGER

For reasons of safety and reliability of any electrical system, any fuse must be replaced with one which has the same electrical characteristics: in case of doubt, consult an expert technician.



DANGER

At the end of eventual replacement of a fuse, ensure the proper keeping: **DO NOT** not leave any foreign objects inside the panel.

NOTE

For more information, refer to the Equipment Manuals provided on board.

6.9 INVERTER (OPTIONAL)

The inverter is a completely automatic high-efficiency device. The inverter transforms the 24V DC voltage into 230 V AC.

- **ON, Switch:**
Position the ON/OFF switch, located on the front panel of the inverter to "ON". The green light "inverter ON" lights up and the inverter starts.
- **OFF, Switch:**
Position the ON/OFF switch, located on the front panel of the inverter to "OFF". The inverter stops and all lit lights switch OFF.

Warning lights

The functions of the warning lights located on the inverter front panel are:

- **Inverter ON**
The green light indicates when the inverter is ON.
- **Overload**
Light lights up when the inverter is overloaded. When the inverter is overloaded, the power limiter reduces the voltage output. According to the load, the inverter will switch OFF after a short period.
- **Overload + ON slow**
When the inverter remains overloaded for a long period of time, it will switch OFF and the "overload + ON" indicators will blink slowly. This takes approx. 20 seconds, after which the inverter will restart automatically. This is called "wait state" and gives the inverter time to recover from any heavy surge load and gives the battery time to recover in case it is flat.

- **Overload + ON fast**
The inverter is switched OFF. When the inverter switches OFF 10 times with intervals no longer than 30 seconds, the inverter will switch OFF permanently and the "overload" and "ON" indicators will blink fast. To switch the inverter ON again, you have to switch the inverter OFF and ON again. When the output terminal is short-circuited, the inverter will overload. The "overload" and "ON" indicators will blink slowly. The inverter will try to start up ten times. If the short-circuit is not removed, the inverter will switch OFF permanently. Remove the short circuit and reset the inverter by switching it ON and OFF.
- **Low battery (nearly flat)**
The inverter is OFF when the battery voltage is too low. If the voltage increases above certain values, the inverter restart automatically.
- **High temperature**
The inverter switches OFF in environments at high temperature and/ or remarkable overload. After the cooling, the inverter starts automatically.



DANGER

When disconnecting the inverter by means of the switch located on the front panel the connection with the mains is not broken OFF.



DANGER

Do not work on the inverter or on its system if still connected to a current supply. Only qualified staff can carry out interventions on the electric system and only after the approval of RIVA.

**DANGER**

Have the inner condition of the inverter checked at least once a year by skilled personnel. Faults like loose connections, burnt wires, etc., with following fire break risks, must be removed immediately.

**WARNING**

The uses supplied by the inverter highly stress the batteries that could discharge as a result.

MAINTENANCE

At least once a month check the correct operation of the inverter.
At least once a month carry out the complete cleaning.
At least once every six months protect the contacts with proper products.

NOTE

For further information on use and maintenance, please refer to the manufacturer's manual.

6.9.1 Inverter maintenance

Component	Maintenance	Notes and precautions
Inverter	Maintenance and check	<p>At least once a year, have the cable and wire connections checked by skilled personnel; they should still be tight and not oxidized.</p> <p>Keep the inverter/battery charger dry, clean and away from dust to ensure a good heat dissipation. Periodically check the good condition of the cooling fan.</p> <p>If the device is OFF during the maintenance and/or repair works, it should be set to prevent an unexpected or unintentional activation:</p> <ul style="list-style-type: none">• Switch OFF the connection with the batteries or remove the inverter fuse;• Make sure that nobody can tamper with the precautions taken.

6.10 GENERATOR

Your yacht is equipped with a generator set, operated by a diesel engine, dimensioned to satisfy the power supply requirements suitably planned in the electric balance for various navigation conditions.

The generator is located in the aft area of the engine room, placed on a stand suitable to bear its weight and vibration induced.

The generator is contained in a sound-proof box, made of removable and insulating panels in painted marine aluminium. This solution allows easy access to the engine and to the alternator for maintenance and inspection, and at the same time a remarkable reduction of noise.

The starter generator is via its own independent 12V battery.

Near the generator is located the battery switch that allows to connect or exclude the generator starter battery.

The generator is equipped with an electronic device for automatically recharging the start up battery by means of its own alternator.

The engine is cooled down, through a cupronickel heat exchanger, by sea water sucked through an independent sea water intake, located between the engines and equipped with a cut-OFF valve and an inspectable strainer.

A second heat exchanger cools down the air inside a sound-proof box and the air necessary for the alternator ventilation.

The inspectable sea inlet strainer effectively protects the cooling circuit from harmful ingress of mud, sand and algae.

The generator draws the air necessary for combustion directly from the engine room through an opening in the stand.

The exhaust is conveyed and silenced through:

- The muffler;
- The water-gas separator;
- The submerged exhaust of the starboard-side propulsion engine.

Besides exhaust gases, cooling water is discharged too. Immediately after the generator exhaust manifold there is the water injection point (raiser), where the mixture of cooling water and exhaust gas is formed.

The generator exhaust, in addition to reducing noise, collects the water in the exhaust pipes when the genset engine is switched OFF, preventing it from flowing into the engine through the exhaust manifold.

The water-gas separator separates the cooling water from the flue gas and discharges them overboard; it also reduces the noise level, which is already reduced by the muffler.

The advantage of using this kind of exhaust is a considerable noise reduction, a lower grade of smoke of the exhaust and a reduction of the operating temperature.

The generator's start up battery can be recharged by the dedicated battery charger (optional) installed on the aft bulkhead of the engine room.

The charger can only recharge the battery when the yacht's power supply is connected to the shore.

Generator exhaust system diagram

VISTA IN PIANTA
PLAN VIEW

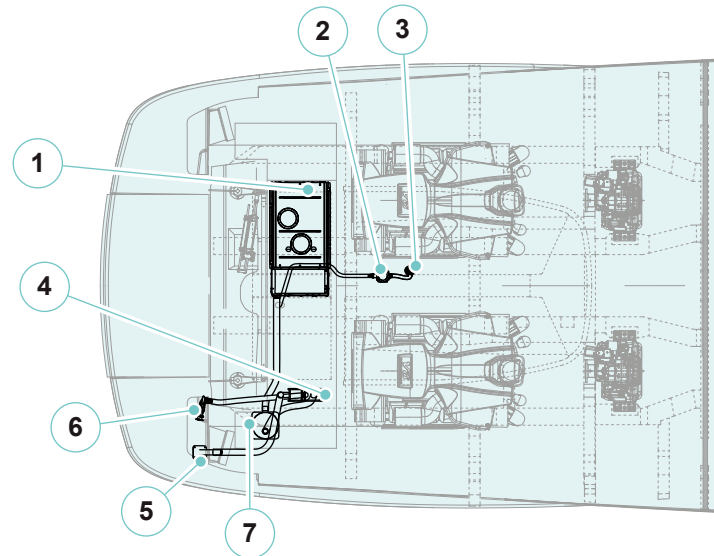

ICONA ICON	DESCRIZIONE DESCRIPTION
①	Generatore Generator
②	Filtro presa a mare generatore Generator seawater strainer
③	Presa a mare generatore Generator seawater intake
④	Separatore acqua-fumi generatore Generator water-gas separator

ICONA ICON	DESCRIZIONE DESCRIPTION
⑤	Scarico fumi generatore Generator smoke exhaust
⑥	Scarico a mare generatore Generation sea exhaust
⑦	Marmitta generatore Generator exhaust

6.10.1 Generator control panel

On the power generator there is a control panel allowing to carry out the controls and the start/stop operations.

A display indicates, by means of the relevant warning lights, the fault detected, thus allowing the monitoring of the power generator set.



WARNING

Before stopping the power generators, disconnect the various on-board uses supplied by them; stopping the power generators under load can irreparably damage the electronic control units of the various utilities, beyond having a negative influence on the generators' operation.



DANGER

Carbon monoxide poisoning

- Start the generator only in a well ventilated area. The carbon monoxide, generated by the inner combustion of engines, is extremely toxic.



DANGER

Explosion/fire hazard

Check for the presence of fumes in the generator area.

NOTE

For further information on use and maintenance, please refer to the manufacturer's manual.

6.10.2 Generator maintenance

Component	Maintenance	Notes and precautions
Lubrication system	Oil specifications	Use specified oils according to Manufacturer's indication.
	Oil check	Check the oil level in the crankcase daily or before each start-up to ensure that the level is in the safe range. Remove the dipstick and wipe the end clean, reinsert as far as possible, and remove. Maintain the oil level between the marks (Min and Max).
	Oil change	For the oil change remove the draining hose from its holder. Position the hose in the oil collecting container. Remove the oil filling plug. Open the oil draining valve located on the engine and drain the oil completely in the container. Change oil according to intervals suggested by the Manufacturer.
	Change oil filter	Remove the oil filter by turning it counter clockwise by means of a suitable wrench. Apply a thin layer of oil to the rubber seal of the new filter. Replace the oil filter according at time intervals recommended by the Manufacturer.
Fuel system	Cleaning and replacement of fuel pre-filter	Replace fuel pre-filter at time intervals recommended by the Manufacturer.
	Cleaning and replacement of fuel filter	Close the fuel supply valve. Loosen the fuel filter by turning it counter clockwise. Remove the filter and clean the contact surface. Tighten the filter on the adapter until the seal comes in contact. Replace fuel filter within the intervals indicated by the Manufacturer.



CAUTION

Do not mix different oils.

Component	Maintenance	Notes and precautions
Cooling system	Cleaning / replacement of the air cleaner	Release the two spring clamps and remove the cover of the air intake. Clean the cover and the base with a clean cloth so as to remove the dirt. Refit the filter and the cover at the base of the filter air intake. Replace the filter at time intervals recommended by the Manufacturer.
	Cooling liquid top up	Before filling the cooling system stop the generator and let it cool down. Close the draining taps. In order to discharge the pressure turn slowly the plug clockwise up to the first stop. Remove the plug after the pressure has been completely released.
	Sea water strainer	At least once a week check for the correct water flow through the strainers. At least once a month check the integrity of the strainers. At least once a month clean the suction strainer. At least once every six months check the condition of the cover seal.



ENVIRONMENT

Recover all waste materials (engine oil, fuel, filter, etc..) according to the rules in force concerning the special waste disposal.



CAUTION

Failure to observe the oil specifications may cause inadequate lubrication/oil pressure and cold-starting difficulties.



DANGER

Hot coolant and steams may cause heavy injuries or even death.



CAUTION

If the oil level is not positioned between the two reference notches do not activate any device.

**CAUTION**

Pay special attention to the coolant level. After the coolant drains, allow coolant to completely refill the engine water jacket. Check the coolant level as prescribed in the Pre-start Checklist.

**CAUTION****Damage due to sea water.**

Sea water quickly deteriorates metals.

Wipe up sea water on and around the generator set and remove salt deposits from metal surfaces.

**CAUTION**

Do not add coolant if the engine is still hot. Adding coolant to an hot engine can cause the cylinder block or cylinder head to crack. Wait until the engine has cooled down.

6.11 SACRIFICIAL ANODES

The submerged metallic parts of the yacht are protected against galvanic corrosions by means of anodes. Check for their wear very frequently, as it depends also (and highly) on environmental factors like sea chains nearby, metal posts or shores, metal hulls moored nearby, electric devices, etc..

The replacement is necessary when the wear exceeds 50%.

The cathodic protection test can be performed on the monitoring system to check the state of the sacrificial anodes.

A reference anode (to be checked periodically) is installed on board, against which the system measures the electrical potential difference and checks if it falls within the correct protection range. An alarm signal is triggered in case of readings outside the safe range.



CAUTION

Each time the yacht is lifted, check for the condition of the propeller, of the protection anodes and of the fastening system.

Replace the anode frequently.

6.11.1 Maintenance of sacrificial anodes

Component	Maintenance	Notes and precautions
Sacrificial anodes	Periodical check	Frequently check the sacrificial anodes' wear conditions; replace them when the volume is reduced by more than 50%.
	Replacement	Loosen the anode fastening nuts, extract the anode and clean the resting surface. Assemble the new anode, tighten the fastening nuts and cover the screw head with silicone.

Periodical check

This operation must be carried out with yacht on dry shore or with the help of a diver.

Have the outer condition of the sacrificial anodes checked and have them replaced if they show evident signs of corrosion or if their volume is reduced to about 50%.

With the yacht out of the water, it is good practice to use a wire brush, to remove the surface layer of oxide and dirt on the external surface of the anodes.



CAUTION

Do not use pressurised water to clean the sacrificial anodes.



WARNING

To clean and check the yacht in water: disable the engines and generator start.



CAUTION

Check the anodes' wear conditions very frequently (when the yacht is on a dry shore or with the help of a diver) and replace them as soon as wear exceeds 50%.



CAUTION

Failure to replace the anodes causes corrosion on other metal parts.

Assembly/Disassembly

The sacrificial anodes are fastened to the yacht in several positions of the hull. We advise you to clean the seat of the sacrificial anode and cover with silicon the screws ends which fasten the anodes. This will easy the replacement of the anodes when worn out. We advise not to tighten the nuts fastening the anodes with glues or other materials which will hinder their removal.

**CAUTION**

Do not cover the contact surface between anode and hull with silicone.

Cathodic protection diagram

VISTA LONGITUDINALE
LONGITUDINAL VIEW

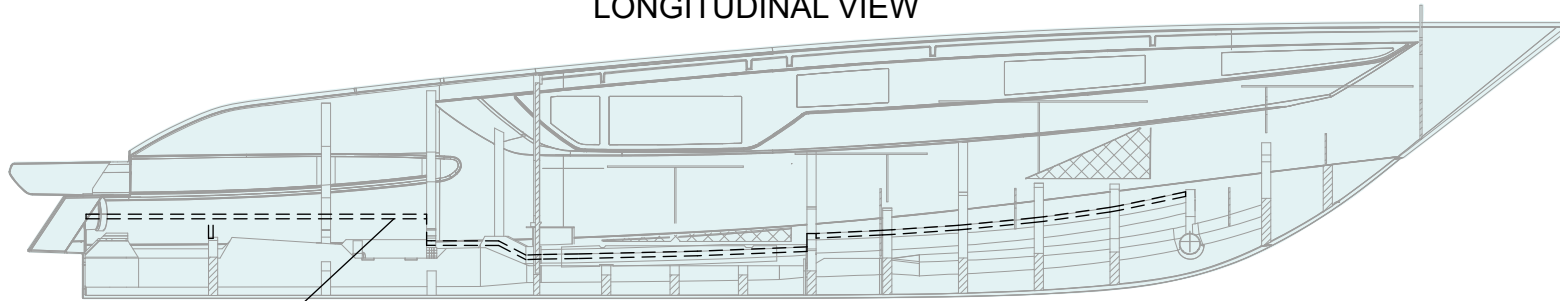

BANDELLA DI MASSA
MASS BAND

VISTA IN PIANTA
PLAN VIEW

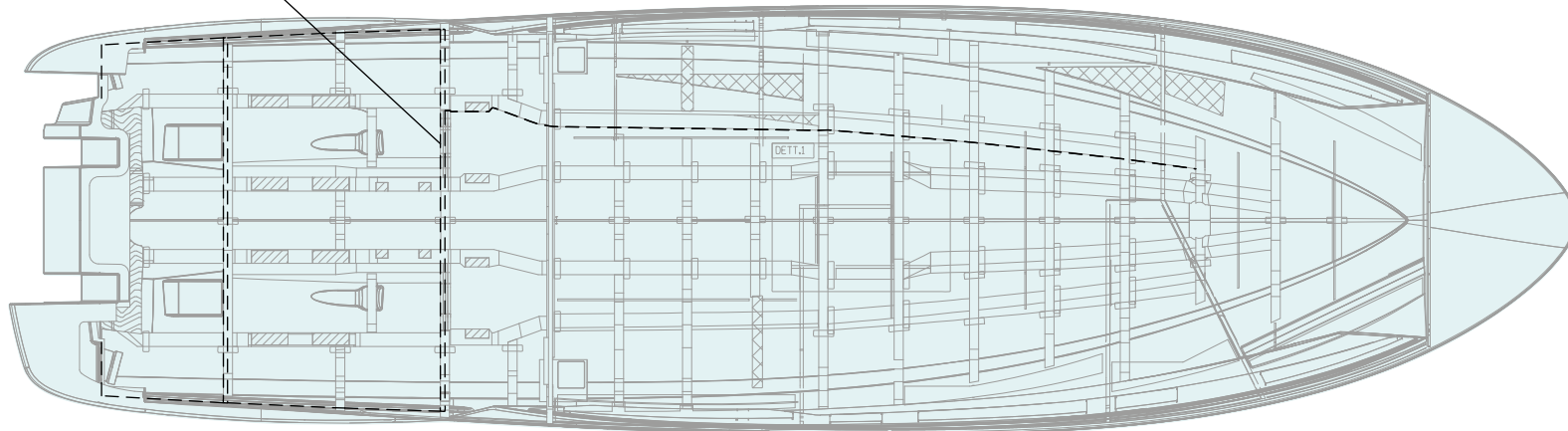

VISTA LATERALE
SIDE VIEW

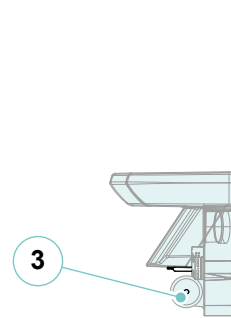

VISTA DAL FONDO
VIEW FROM THE BOTTOM

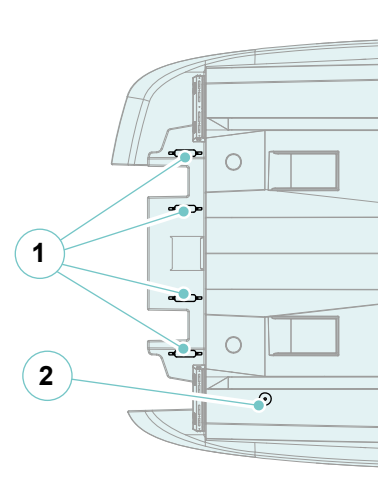

ICONA ICON	DESCRIZIONE DESCRIPTION
1	Anodo sacrificale ovale Oval sacrificial anode
2	Piastra di massa Ground plate
3	Anodo sacrificale elica di manovra di poppa (opt) Sacrificial anodes stern thruster (optional)

Riva

56 RIVALE *supera*

PROPULSION SYSTEMS

CHAPTER 7

7.1 PROPULSION SYSTEMS

The engine room houses all the components for the propulsion of the yacht.
The propulsion system consists of two equal units.

Each one includes:

- Engine MAN V8 1000Hp (Opt: V8 1200Hp);
- Flexible engine supports;
- Inverter “ZF 510 V”;
- Rigid inverter supports;
- Microtem seal;
- Propeller shaft;
- Propeller shaft support;
- Propeller;
- Rudder;
- Shaft flange.

ENGINES:

They have following features:

- | | |
|--------------------|--|
| • Model | V8 1000 (Opt: V8 1200) |
| • Make | MAN |
| • No. of cylinders | 8 |
| • Configuration | 90° a V |
| • Effective output | 735/1000 kW/mhp (Opt: 882/1200 kW/mhp) |
| • Rated speed | 2300 rpm |
| • Dry weight | 1780 kg (opt: 1941 Kg) |



CAUTION

Do not operate the yacht with an engine of rated power exceeding the maximum recommended power (actual power engine series).

Among all the possible interventions to carry out on the engines in case of need (see the operating instruction manual) hereunder are the most useful, according to our experience:

- Replacement of the fuel filters.
- Replacement of the oil filters.



CAUTION

The engine data boards are very important in case of repairs.
Therefore keep them with care together with the warranty.

Remember that you can obtain a flawless operation and a high power only by respecting the prescribed maintenance intervals and by using the specified fuels and lubricants.

The engines have been installed on suitable elastic supports, which absorb vibrations and allow the minimal motion of the engines; in this way structures and devices connected with them are not damaged.

Besides, the elastic supports easy engine position adjustment, both for a new installation or after the required run in.

NOTE

For further information on use and maintenance, please refer to the manufacturer's manual.

7.1.1 Start of propulsion engines**Commissioning**

Before starting a new or overhauled engine, carefully read the relevant Manufacturer's Documentation. During the first service hours it is advisable to have new engines run below 75% of their maximum load and at variable speeds. After this initial run-in, the engine should be brought up to full output gradually.

**CAUTION**

Use only approved technical fluids; otherwise the Manufacturer's warranty will become null and void and the engines can get seriously damaged.

Daily start-up

Before daily starting of the engine, check fuel level, coolant level and engine oil level and replenish, if necessary. In case of need, fill with fuel, coolant and oil mix.

**CAUTION**

Engines must always be started with gear boxes at idle run and throttle levers must be set at minimum speed.

**DANGER**

Before starting an engine, ensure that nobody is standing in the dangerous area of the engine room.

Cooling liquid

Fill the cooling system of the engine with a mixture of drink water and anti-freeze or anti-corrosion agent.

- Pour in coolant slowly in the expansion tank through proper filler.
- For the quantity of coolant, see the relevant manufacturer's documentation.

Engine oil

Pour lubricating oil into engine by means of proper filler neck.
For refuelling quantities, refer to the Manufacturer's manual.

Sea water suction pumps**CAUTION**

Do not let raw water pump run dry!
Make sure that all valves of the raw water circuit are open.
Drain the pump in case of freezing danger.

Oil level check

Check engine oil level only approx. 20 minutes after the yacht has been switched OFF.

- Pull out dipstick for oil level check.
- Wipe it with a clean, dry and lint-free cloth.
- Place it back up to retainer.
- Pull out dipstick again.

The oil level should be between the two notches in the dipstick and must never fall below the MIN notch.

Top up oil as necessary.

**CAUTION**

Do not top up oil exceeding the MAX notch of the dipstick. If the oil level is too high, damage to the engines may occur!

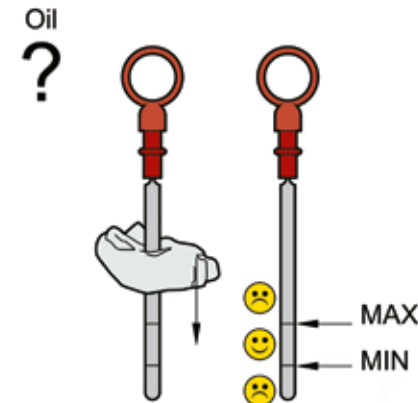

Ensure utmost cleanliness when handling fuels, lubricants and coolants.

Waste oil drain

It is possible to drain the used oil from the propulsion engines by using a manual pump activated by means of the relevant lever.

Procedures for start-up

- Check that the yacht functions are included on the main electrical panel and on the engine electrical power supply panels in the engine room.
- Place the throttles to central idle position.
- Bring the E-Key close to the engine start panel. The LEDs on the 'IGNITION' buttons will light up and the system will allow the engine to start.
- Then proceed by pressing the engine "**START**" button.
- Check if oil pressure reaches the normal value within 10 seconds.
- Check if cooling water circulation is correct.
- Once the first engine is running and only when its operation has proved to be regular, start the second engine too.
- Start the port engine in the same way as described for the starboard one.
- Warm up the engine up for about 2-3 minutes at 1000 rpm max.
- Check the alternator charge.
- Activate the bow thrusters by means of the control panel installed in the helm station.

**CAUTION**

Do not press the starter button for more than 10 consecutive seconds; if the engine has not started, release the button, wait for about 30 seconds and then press the starter button again.

Throttle operation

- Move both throttles to the "NEUTRAL" position.
- Press the power button 2 times from the helm station.
- Select the operating mode of the handcuffs using the buttons on the handcuffs.

**CAUTION**

If you have to connect the batteries in parallel for the start-up of the propulsion engines, it is suggested to disconnect the electric devices in order to avoid current rushes or drops.

**CAUTION**

Should a magneto-thermal trip, do not try repeatedly to reset it, but check the relevant electric system condition.

**CAUTION**

We suggest avoiding slow running for more than 5 minutes. The slow run implies major wear of the engine mechanical parts and is the most harmful from the point of view of polluting exhaust.

7.1.2 Checks after start of propulsion engines

Following correct engine startup, some checks must be performed:

- Check that water is being ejected from the semi-submerged exhaust; if this does not happen, accelerate slightly with the engine in neutral for a few seconds. If there is still no trace of water ejection, stop the engines, identify the fault or call for assistance.
- Check for strange noises or excessive smoke. If these are detected, stop the engines and call for assistance.
- Check that alternators load the batteries.
- Verify the efficiency of the instrument system.
- Plug out the shore cable if connected.
- Remove moorings and check for loose mooring ropes or floating objects hindering the propellers' movement.



DANGER

Make sure that no crew stands in front of gas exhausts and near the mooring ropes.

7.1.3 Stop of engines

Do not immediately stop the engines after a full-load operation, but let them run low (about 5 minutes) to balance the temperature differences.

- Bring the levers back to the central neutral position on the inverter.
- Press the **STOP** buttons on the engine control panels and release them only after the engines have come to a complete stop.
- Press the **IGNITION** buttons. The signal LED will switch OFF.
- Disconnect unnecessary magneto-thermal switches.



CAUTION

With engines stopped carry out following:

- Disconnect all unnecessary electric utilities and check the general status of the switchboard as well as the voltmeters and ammeters indications;
- Check the switches of the bilge pumps and their regular operation;
- Check for leaks;
- Rinse the yacht with fresh water;
- Connect the shore electric power supply;
- Keep the engine room extractor running for about 30 minutes, for ventilation and air cooling.



DANGER

Make sure that the engines cannot be started by unauthorized staff.

7.1.4 Engine emergency procedure

Due to a mechanical or electrical fault, the normal procedures for engine stop might not be sufficient; it is therefore necessary to stop the engines with the EMERGENCY procedures.

In the event of an engine malfunction alarm, the luminous ring of the relative start button will flash red on the helm station.

Recognise the fault on the helm station or in the engine room.

- **EMERGENCY STOP buttons:**

The EMERGENCY STOP buttons are located on the helm station: keep them pressed until the engines actually stop.

- **From the engine room:**

Reach the engine room and access the engine control panels; press the red mushroom emergency stop button.



CAUTION

The emergency stop causes heavy stress on the engines with consequent hazard of component damage. Use only in case of real need.



WARNING

The engines emergency stop controls must be used only in case of real emergency.

Never use these controls during the normal engine stop procedure.



DANGER

Before restarting the engines after an emergency stop, make sure to find and to clear the reason of the fault.

7.1.5 Propulsion engine maintenance

Component	Maintenance	Notes and precautions
Lubrication system	Replacement of the oil separator filter	Replace the separator filter, according to the time intervals suggested by the Manufacturer.
	Oil level check	Check the oil level by means of the special dipstick; make sure the level is included in the allowable range (MIN - MAX). Do not start the engines if the oil level is not included between the two reference marks, as indicated in the Manufacturer's Manual.
	Oil and oil filter replacement	Replace engine oil according to time intervals and oil type suggested by the Manufacturer.
Fuel system	Fuel filter replacement	Replace fuel filter within the intervals indicated by the Manufacturer.
	Air cleaner replacement	Replace air filter within the intervals indicated by the Manufacturer.
Cooling system	Coolant check	Make sure the coolant is in the tank (lever sensor, reference plate, built-in eyelet).
	Cooling system filling	For coolant features refer to the User's Manual of the Manufacturer.
	Cooling system drainage	Drain the coolant only when the engine is stopped; follow the procedure indicated by the Manufacturer.

**DANGER**

A wrong use, a wrong maintenance, tampering and replacement of pieces, can cause serious damages or lethal events, beyond damaging the equipment.

The interventions on the electrical and mechanical equipment must be carried out by qualified staff after having examined the Manual delivered by the Manufacturer.

**ENVIRONMENT**

Dispose of waste materials (engine oil, fuel, filters, etc..) with respect for the environment and according to the laws in force.

Use only authorized disposal procedures, in case of doubts, contact the Port Authority.

**DANGER**

Any maintenance procedure on the engines is to be carried out with engines shut OFF, after they have sufficiently cooled down and after seeing to the prevention of their being switched on by disconnection of the magneto-thermal switches.

**CAUTION**

Use only approved fuels, otherwise the Manufacturer's warranty will become null and void.

**CAUTION**

Do not top up oil exceeding the MAX notch of the dipstick.
If the oil level is too high, damage to the engines may occur!

**DANGER**

Do not use open flames, do not generate electric sparks. Do not smoke. Avoid ignition sources. Risk of fires and explosions!

**DANGER**

Compressed air at high pressure may create the risk of injuries. Do not direct compressed-air jets at persons. Wear protective goggles, safety masks and ear protectors.

**DANGER**

Hot oil can contains combustion residues which are harmful to health. Risk of injury and scalding! Wear protective clothing, gloves and goggles/safety mask. Avoid contact with skin. Do not inhale oil vapour.

**DANGER**

Because of the high temperature in the engine room, oil or fuel leaks can evaporate and create a serious risk of fire. Regularly check the integrity of the system.

**CAUTION**

It is absolutely necessary to view with RIVA the documentation of the different components provided by the Manufacturer; for any problem relevant to the use or maintenance, please directly refer to the RIVA After Sales & Service Department, listed in the documentation provided by the Manufacturer. In any case there are some small procedures that can be carried out by the crew on board, after consulting the operation manual.

**ENVIRONMENT**

Handle used fuel filters as special waste.

**DANGER**

Coolant is hot and under pressure. Risk of injury and scalding! Let the engine cool down and wear protective clothing, gloves and goggles safety mask.

**CAUTION**

Cold coolant in a hot engine causes thermal stress with the risk of formation of cracks in the components. Fill/top up only a cold engine.

**CAUTION**

If the oil level is not positioned between the two reference notches do not activate any device.

7.2 GEARBOX

The main functions of a marine gearbox are the following:

- Couple the engine with the propeller shaft and reduce the number of revolutions of the propeller;
- Reverse the motion direction;
- Interrupt the propeller shaft motion (idle).

The gear boxes are provided with several documents.

NOTE

For further information on use and maintenance, please refer to the manufacturer's manual.

7.2.1 Gearbox maintenance

Component	Maintenance	Notes and precautions
Gearbox	Oil level check	For the correct maintenance and check procedures, refer to use manual delivered by the Manufacturer.
	Oil change	For the kind of oil and grade of viscosity recommended by the Manufacturer, refer to the gearbox plate.
	Oil filter change	Have the scheduled maintenance operations performed at the correct time schedule by authorized and skilled personnel, in order to keep the gearboxes perfectly efficient.



WARNING

The gearboxes are provided with emergency controls in case of fault. Refer to the Manual delivered by the Manufacturer.



CAUTION

The use of the gearbox with a low quantity of oil may damage the gears. An excessive quantity of oil may cause seals and vents to leak and can remarkably increase the operation temperature.



WARNING

Under normal operation conditions, the gear change can be carried out with the engine at low speed. However, in case of emergency, gear shifting can be carried out with the engine at high speed, thus remarkably reducing clutch life though.

Oil level check

Check the oil level only when the engine is at a standstill. The proper oil level is between the upper and the lower notch of the dipstick.

After the first oil filling, a repair or the cleaning of the oil filter, the gearbox must be run for about two minutes.

Next the oil level check has to be carried out again two minutes after the engine has stopped.

**CAUTION**

Before starting checking the oil level, check that the gearbox oil temperature complies with the normal operating specifications.

**ENVIRONMENT**

Recover waste oil following the norms in force, relevant to special waste disposal.

**DANGER**

Service the gear box only if engine and propellers are stopped and the magneto-thermal is OFF. Before starting the inverter, carry out the filling and the consequent check of the oil level. The use of the gearbox with a low quantity of oil may damage the gears. An excess of oil might cause leaks to the seals and to the vent and increase remarkably the operating temperature.

7.3 SHAFT LINE

7.3.1 Propeller shaft and through-hull seal

The propeller shaft is fastened to the gearbox by means of the flange coupling and is aligned on the three points represented by the gearbox, by a water-lubricated stuffing box seal and by the shaft support.

The stuffing box case includes a piece fixed to the hull and an adjustable piece. The adjustable piece is closed to the fixed one, in order to compress the seal, located inside the stuffing box case.

It's very important that the seal disposal is compressed, in order to avoid irregular pressures on the seal seat that might compromise life and efficiency of seal disposal.

The outer shaft support includes a Neoprene bushing which uses the sea water as a lubricant.

Check it every season, as it might get worn quickly during cruising, especially in sandy waters.

The bushing wear causes a vibrations increase.

When the yacht is on a sandbank, a good technician can easily consider, by moving the shaft, if the wear demands the replacement of the bushing.



DANGER

Never approach the shafts while they are rotating.

7.3.2 Mechanical shaft seal

The mechanical seal has the function of preventing seawater from entering the yacht through the space between the propeller shaft and the hull. It consists of two rotating rings held in contact by combined forces. One ring is defined as rotating and rotates with the shaft; the other stationary is fixed to the hull. The structure of the stationary part is made by the use of industrial techno polymers, which guarantee not to run into problems such as ageing or the possibility of drilling or fire. The seal between the parts is made by means of o-rings. The cooling of the seal is ensured by the access of water through the flushing duct.

Before starting the engine

- Make sure the seal is clean on the outside as well. If foreign bodies are present, it is recommended to wash thoroughly.
- Make sure that the flush water valve is open and there are no leaks from the sealing surfaces.



DANGER

Do not approach the shafts when they are rotating.



CAUTION

In order not to compromise the seal, it is essential never to operate it without cooling water.



CAUTION

Bleed the mechanical seals each time the yacht is hauled/launched.

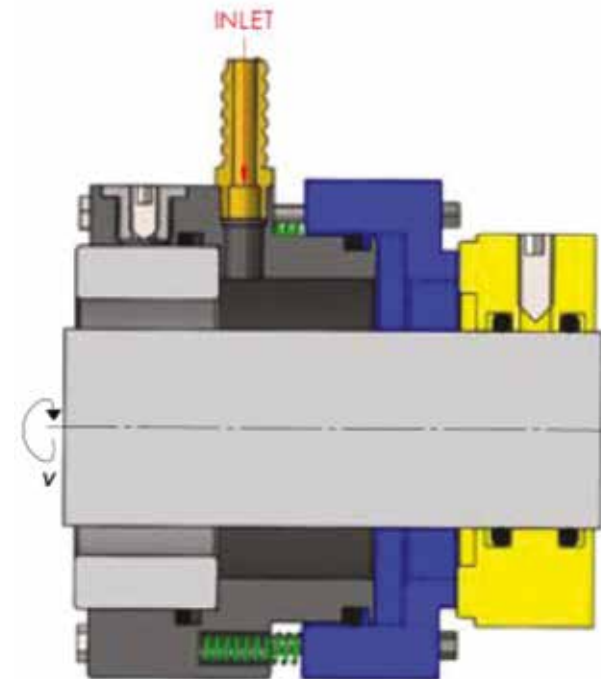

**WARNING**

RIVA yachts are designed to have a correct transversal trim with full optional equipment, in the presence of propellers and shafts of respect. In case the yacht is not equipped with all the optional extras and with respect shafts and propellers, weights are inserted to compensate and make the trim correct.

MAINTENANCE

At least once a week, check that there is no water seepage.

At least once a month carry out a cleaning.

Periodically:

- Check the condition of the seals;
- Check the compression of the seal and when necessary make a compression;
- Check and maintain the cooling circuit of the seals to prevent dirt, algae and foreign bodies from blocking the flow of cooling water, causing the seals to overheat and permanently damage them.

NOTE

For further information on use and maintenance, please refer to the manufacturer's manual.

1. Through-hull
2. O-ring
3. Stationary support
4. O-ring
5. Stationary ring
6. Rotating ring
7. O-ring

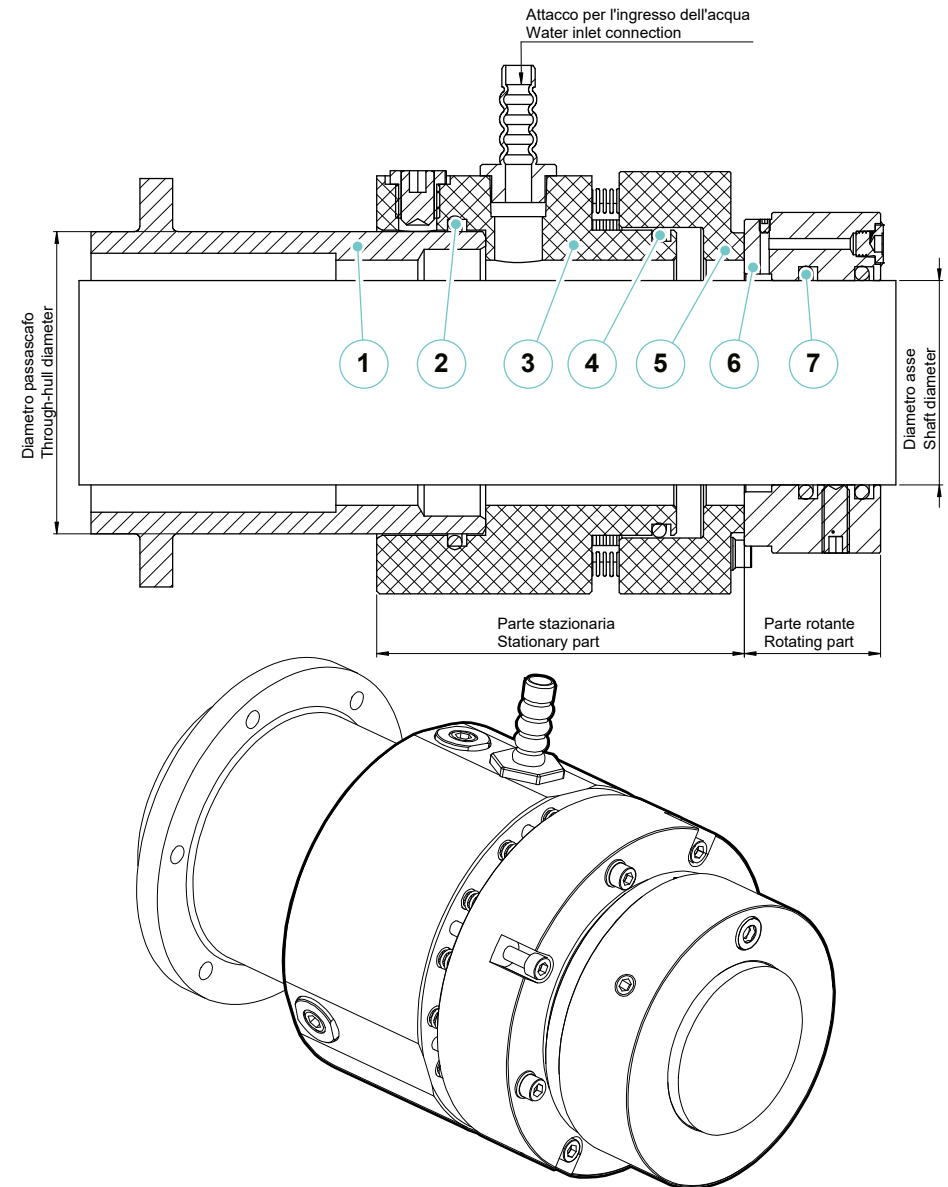

7.3.3 Shaft line maintenance

Component	Maintenance	Notes and precautions
Shaft support bushings	Periodical checks (at least once a month) Assembly/disassembly	The Neoprene bushing of the shaft support, when sailing in waters with sandy suspensions, may wear rapidly. The bushing wear causes a vibrations increase. With the yacht in a dry shore, a good technician can easily evaluate, by moving the shaft, if the wear is so bad as to need the bushing to be replaced.
Stuffing box seal	Maintenance and check	With yacht moored at the marina, daily and before set up navigation.
Shaft lines	Periodical checks (at least once a month)	It is essential to keep always the propellers and shafts clean; the formation of parasites or the presence of foreign bodies like cables, cloths or plastic bags lead to propulsion power reduction, to propellers cavitation with consequent surface damage, and to vibrations causing damages to the stuffing box seals and to the bushings of the shaft supports. Checking and eventual cleaning may be carried out with the yacht in a dry dock or with the help of a diver. To clean scrape the barnacles, without engraving the metal, polish them with sand paper at thin grain.

MAINTENANCE

At least once a week check for water penetration.

At least once a month carry out the cleaning.

Periodically:

- Check the status of the seals;
- Check the compression of the seal and when necessary carry out the compression;
- Check and service the cooling circuit of the seals in order to prevent dirt, seaweeds and foreign bodies from blocking the cooling water flow, thus causing the seals to overheat and, consequently, their irreparable damage.

Periodical checks

Check the shaft backlash (1) trying to move the shaft on a side back and forth to verify the backlash of the shaft supporting bushing (2).

Assembly/disassembly

- If the propeller shaft (1) shows backlash, the water lubricated neoprene bushing (2) could be worn out; in this case replace it.
- Remove completely the antifouling to reveal the screwdriver screws (3) which lock the bushing positioned.
- After the propeller (4) and the shaft (1) have been disassembled, by means of a plastic tube with a slightly smaller diameter, pull out the bushing (2).

For reassembly, repeat the above-mentioned operations in reverse sequence.

- Do not use grease between propeller shaft and bushing. Remember to fasten the screws (3).

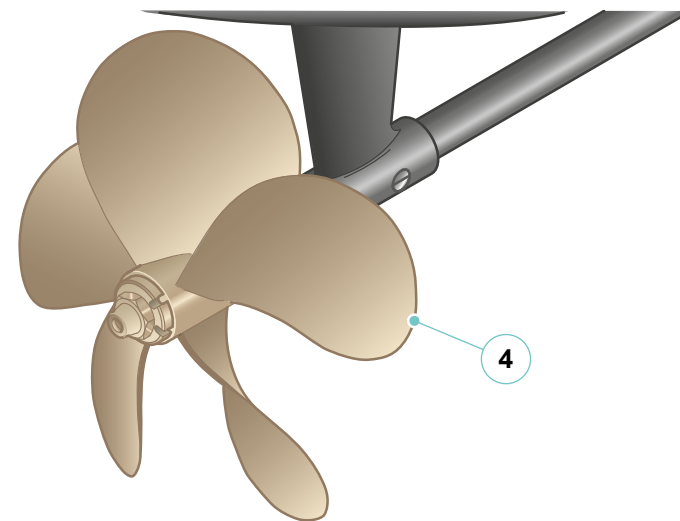
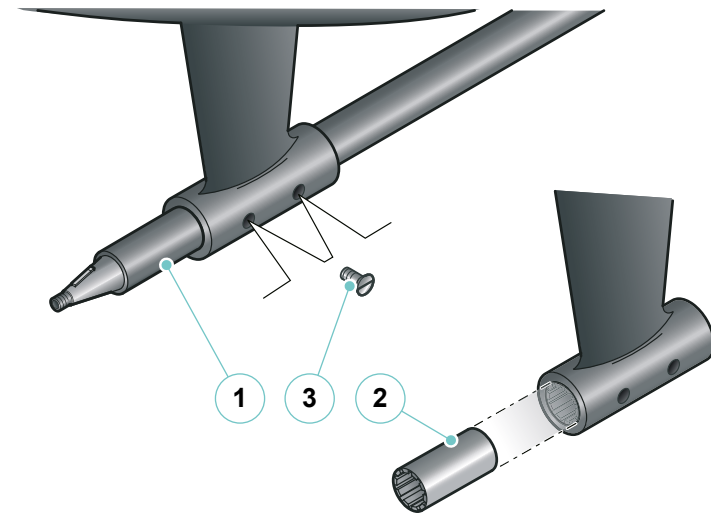
**CAUTION**

For spare part request contact the RIVA After Sales & Service department.

**CAUTION**

Remember to retighten the fixing screws (3) of the bushing on the shaft support. Never use grease or other lubricant between propeller shaft and Neoprene bushing.

7.4 PROPELLERS

The propellers have been designed in order to result lightly “unloaded” with a new yacht, hull clean and without displacement overloads: in this way the engines will develop all their power in average normal operating conditions, with hulls and propellers not perfectly clean and some overloads on board. Periodically check if the propellers are not too “dirty”, as this leads to a fast performance decrease and to a vibration increase.

In case of impact with the depth or submerged/semi-submerged bodies, check propellers and shafts immediately; in case of considerable vibrations, reduce the revolutions to the minimum and steer toward the harbor for repair, as a vibration increase might damage the propelling devices and the yacht structure.



CAUTION

RIVA yachts are designed to obtain a correct transversal trim with full optional equipment, and with spare propellers and shafts.

If the yacht is not provided with full optional and with spare propellers and shafts, some weights are inserted to correct the transversal trim.

The above-mentioned weights can be removed or displaced as soon as the yacht is provided with a new equipment.

7.4.1 Maintenance of the propellers

Component	Maintenance	Notes and precautions
Propellers	Periodical checks	<p>The propeller check should be performed according to the floating waters. Inspection and possible cleaning may be carried out with the yacht in a dry shore or with the help of a diver.</p> <p>Check if the propeller blades have notches, fractures, fouling or barnacles which may have a negative influence on the yacht performances during navigation.</p> <p>If you notice corrosion, check the anodes conditions and replace the propellers for major failures.</p>
	Assembly/disassembly	<p>The starboard and port propeller are not interchangeable between them neither with others as designed according to specific features of your yacht.</p> <p>Replace only with genuine spare parts supplied by the RIVA After Sales & Service department.</p>

Periodical checks of propellers:**DANGER**

To clean and check the yacht in water: disable the engines and generator start.

It is advisable to carry out this operation by yacht in dry shore because maintenance is in this way eased. Check if the propeller paddles show notches or breaks, scales or barnacles, which may have a negative influence on the yacht output during navigation. If you notice corrosion, check the anodes conditions and replace the propellers for major failures.

Propellers assembly/disassembly

The propellers (starboard and port) are not interchangeable between them; they are bronze meltings according to specific features of your yacht. The extreme end of the shaft (9) is conical and a little key allows the coupling with the propeller (5) which must be inserted up to the shaft catch and leaving the propeller stretching out from the shaft plane of 2÷3 mm.

**CAUTION**

Do not replace the propellers of your yacht with other of doubtful origin. Contact the RIVA After Sales & Service Department. Each yacht model has its own propeller.

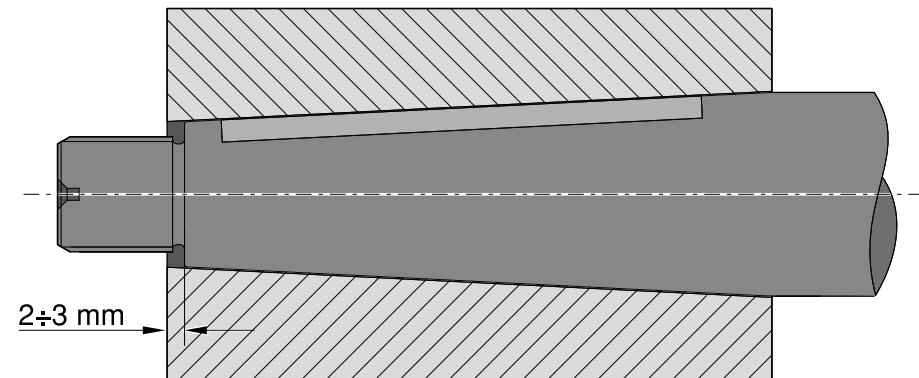

Pieces should not show burrs or dents to make the coupling effective. It is essential to lubricate them with plenty of silicon grease.

Tighten the nut (4) locking the propeller on the shaft (9); on the propeller hub there are three holes to 120°. Tighten as necessary to insert the dowel (3), to avoid natural loosening.

For disassembly keep an extractor at disposal so as not to deform the propeller.

In case of obstacles or excessive sticking, heat the propeller to expand the coupling and ease the removal.



CAUTION

Avoid the use of hammers or mallets to pull out the propeller. The pull out force must be uniformly exerted on the entire hub of the propellers.

Hereunder a list of the components of shafts and propellers line:

1. Screw
2. Propeller anode
3. Dowel
4. Nut
5. Propeller
6. Shaft support bushing
7. Shaft support
8. Countersunk screws with notch
9. Propeller shaft

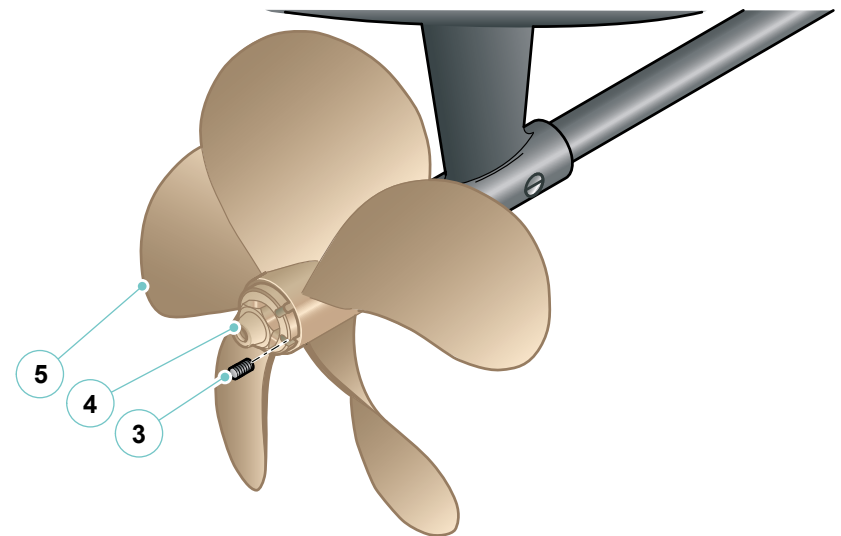
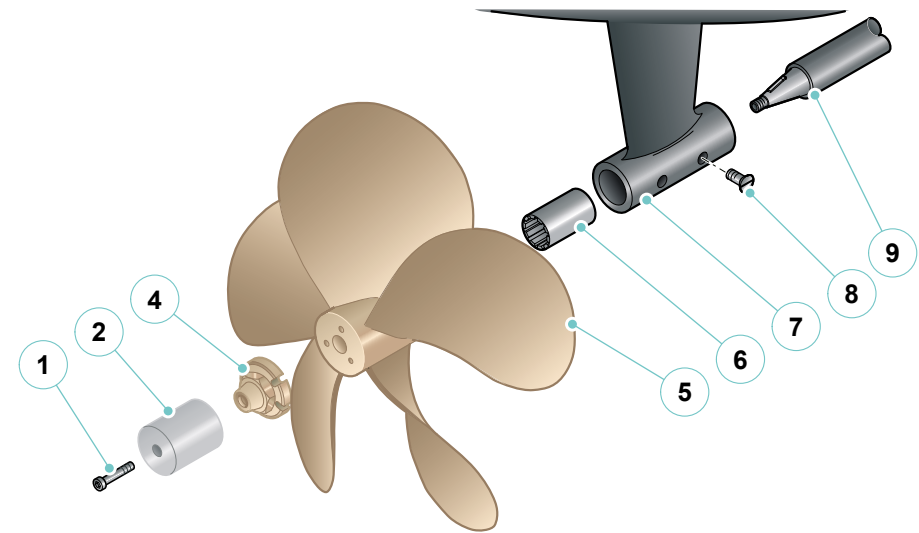

7.5 EXHAUST SYSTEM

7.5.1 Engine exhausts

The engine exhausts are semi-submerged silenced exhausts. The exhaust gases leaving the engine are conveyed, through insulated stainless steel manifolds, to the mixer where they are cooled with the sea water on leaving the engine. Subsequently, they are conveyed to the muffler and, through the cooled fiberglass end-pipe, they exit through the transom at a semi-submerged level. The exhausts have to be checked at regular intervals to avoid the formation of build-ups that could prevent the correct gas ejection.



WARNING

When starting the engines, check that water comes out of the exhausts; this means that the engines cooling system works correctly and that the exhaust is cooled. Accelerate if no water comes out. If the problem continues, contact the RIVA After Sales & Service Department.



CAUTION

A strong smell and a light smoke from exhaust insulation are normal during the first period of use.

MAINTENANCE

At least once every three months carry out the tightening of the discharge raiser bolts.



CAUTION

Temperature sensors are installed on both engine exhausts.



CAUTION

Avoid prolonged use of engines at low speeds to avoid overheating of the exhaust pipes due to reduced cooling water circulation.

Engine exhaust diagram

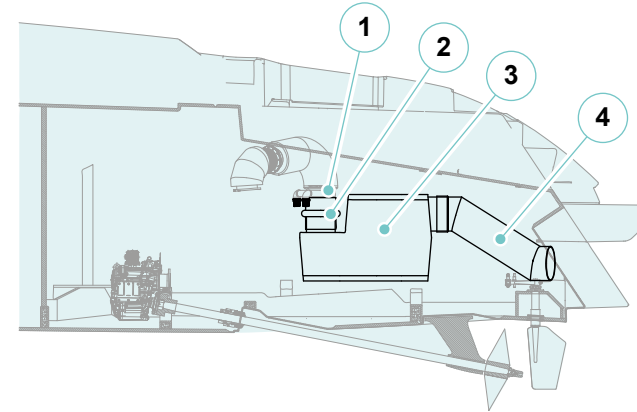
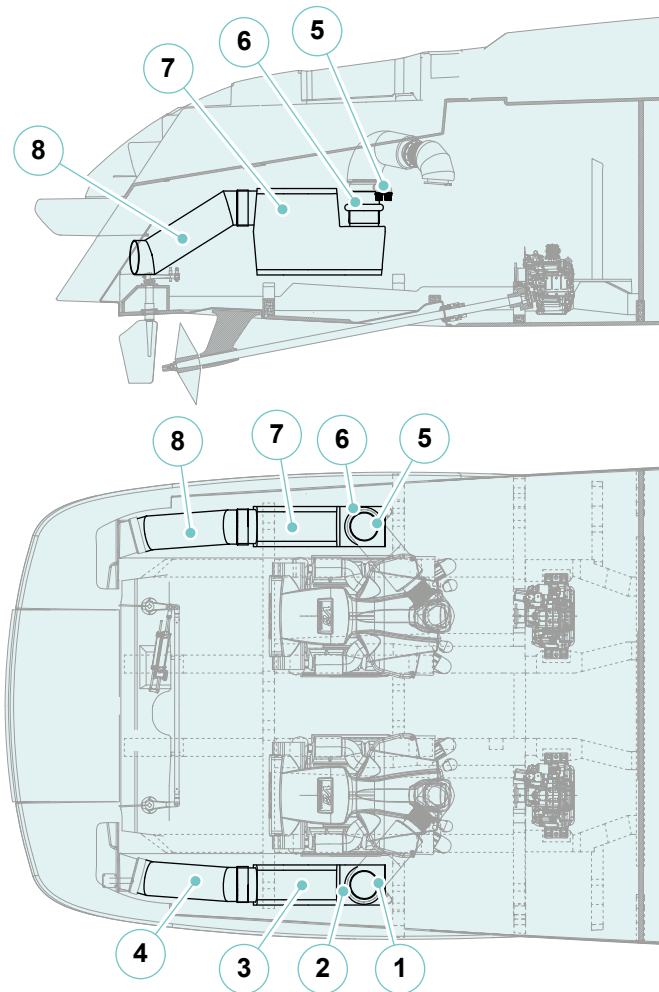

- 1. Starboard riser
- 2. Starboard sleeve
- 3. Starboard muffler
- 4. Starboard VTR drain hose

- 5. Port riser
- 6. Port sleeve
- 7. Port muffler
- 8. Port VTR drain hose

7.5.2 Maintenance of the engine exhausts

Component	Maintenance	Notes and precautions
Exhausts	Periodical check (as necessary, according to the floating area)	<p>Check the underwater exhaust terminal cleanliness conditions periodically. Clean, if necessary.</p> <div style="border: 2px solid yellow; padding: 10px; text-align: center;">  <p>CAUTION</p> <p>Carbon deposits, marine growths and fouling may affect the engine regular operation, causing performance degradation and serious damages.</p> </div>

MAINTENANCE

At least once every 3 months, tighten the bolts of the exhaust raisers.



CAUTION

Temperature sensors are installed on both engine exhausts; warning lights are visible on the engine control panels on the helm station and, when illuminated, indicate that the temperature inside the exhausts is too high.



DANGER

Carbon Monoxide poisoning hazard

Ensure that the engine exhaust system operates correctly. Carbon monoxide is extremely toxic. The exhaust system removes the combustion gas created by the engine and allows the correct ventilation of the stern. Inspect the system tightness on a frequent basis. Leaks may permit carbon monoxide exposure.

7.6 FUEL SYSTEM

The fuel system of your yacht consists of two tanks located in a engine room behind the forward bulkhead, reinforced internally, certified and tested by RINA.

Each tank is made in accordance with current regulations, fuel-resistant and corrosion-proof, fixed to the bottom and side of the tank and resinated to the bulkhead of the engine room; The total storage capacity is 2300 liters.

Inside the tank, anti-barking bulkheads (diaphragms) have been inserted to prevent excessive overflow of fuel due to wave motion of the sea, while hermetically sealed inspection flanges are bolted onto the tank, through which the various fuel supply and return passages.

The free filling nozzle, through which the gravity tank is filled, closed by a screw cap, are placed on the side of the yacht.

The yacht's fuelling board is equipped with a flow switch which has the function of preventing unwanted fuel leaks from the plug and the vent that can stain the deck and pollute the surrounding waters.

The presence of condensate water in the tank favours the development of microorganisms in the fuel that cause premature filter clogging and corrosion damage. It is therefore necessary to drain condensate water from the tank and separate separator filters (engine prefilter, engine filters and generator filter) at regular intervals. At the bottom of the reservoir is a cavity with drainage device, where impurities and condensation water can be collected.



CAUTION

We recommend filling the tank some hours before departure; in this way, the impurities and water in the fuel will decant on the tank bottom as they are both heavier than fuel.

The particular shape and arrangement of the tank eases settlement of possible impurities or water which may be present in the fuel; it is advisable to carry out tank drain, by means of the special air valve, a few hours after refuelling, and possibly while the yacht is stopped.

It is also advisable to connect the bleeding valves delivery to a hose, conveying the liquid into a bucket in order to avoid collecting flammable fuel in the bilge, thus preventing the formation of noxious exhalations.

NOTE

While boarding, the fuel flow produces a lot of foam; if it comes out, you might think the tank is full. Therefore, it is good to wait for a few minutes and then top up, in order to be sure that the tank has been completely filled.



CAUTION

The inlet plug carries the indication "DIESEL" to avoid accidental input of different fuels. To avoid damage to the system and tanks, we recommend replenishing by gravity and not by pressure.

The fuel level is indicated by the digital display mounted on the helm station. In addition, here is a visual fuel level in the engine room located on both tanks.

**WARNING**

The sensor reading can be distorted by the temperature, because the specific weight of fuel varies according to this last parameter and to the yacht trim. Therefore before setting-up for navigation, always refer to the visual level in the engine room.

**WARNING**

The bilges of the engine room must always be kept clean, so that fuel or oil leaks or penetrations from the engines or the generator can be easily noticed. If leaks are noticed, it is necessary to stop the engines and to let them cool and only afterward, if possible, repair the leak. Finally clean the bilges.

**ENVIRONMENT**

Every marina has dedicated toxic waste disposal areas. It is recommended not to scatter waste that can contaminate the environment (such as used oil, fuel, oily liquids, batteries, etc..).

Prior to perform any job in the engine room, disconnect the bilge pumps switches, to prevent accidental fuel, lubricant or other liquid leaks and therefore the pollution of the yacht surrounding waters.

**ENVIRONMENT**

It is forbidden to discharge bilge water mixed with oil or diesel fuel into the sea, because this can cause of serious pollution. Check periodically the level of possible oily waters contained into the collecting tanks under the engines, should their level be close to bilge over flooding, disconnect the magneto-thermal of the bilge automatic pump system, to avoid accidental spills, until the tanks have been completely drained in accordance with the environmental legislation. During the maintenance operation in the engine room, it is compulsory to disconnect the magneto-thermal of the bilge pumps automatic suction system, avoiding in this way accidental spills.

**DANGER**

Because of the high temperature in the engine room, oil or fuel leaks can evaporate and create a serious risk of fire.

**DANGER**

Fuel leak can cause a fire to break.
Check regularly the integrity of the system.

**CAUTION**

The bleeding procedure should be carried out every two or three refueling operations.

**ENVIRONMENT**

Handle water mixed with fuel and dispose of it according to the rules in force. Use only authorized disposal procedures; in case of doubt, refer to the Port Authorities.

**EXPLOSION/FIRE/POLLUTION DANGER**

Fuel system connections that are too loose or too tight can leak, resulting in fuel loss, environmental pollution and explosion/fire danger.

**DANGER**

A fuel leak can generate fire and explosion hazard.
Fuel cannot be stowed inside the garage.

**DANGER**

It is forbidden to smoke, use naked flames or keep mobile phones switched on during refuelling.

**EXPLOSION/FIRE DANGER**

- Stow flammable material in a safety-approved container. Never stow flammable material in non-vented areas.
- Check bilge and engine room for fumes.
- Keep the ventilation system free of obstructions. Never modify the ventilation system.
- Inspect the fuel system for leaks.

Fuel system diagram:

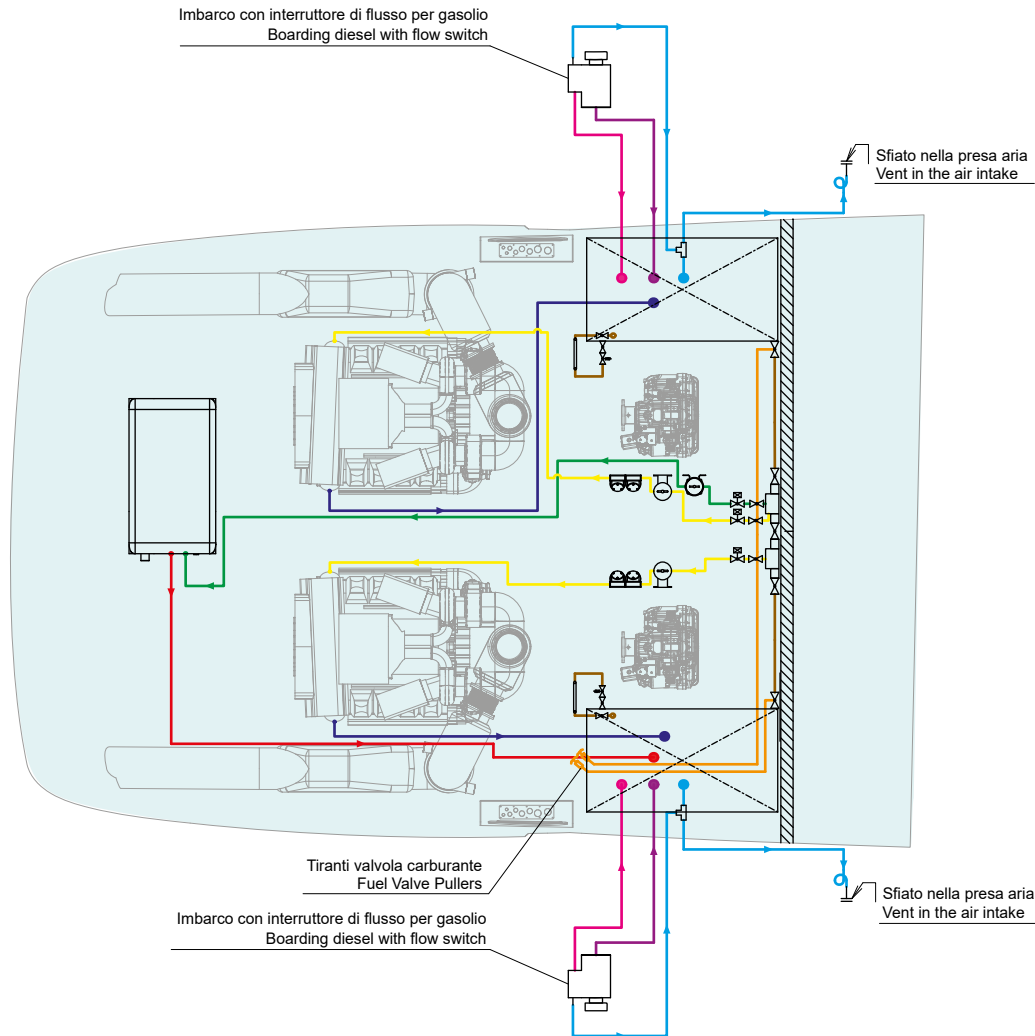

ICONA ICON	DESCRIZIONE DESCRIPTION
	Valvola a sfera Ball valve
	Valvola di non ritorno Non-return valve
	Elettrovalvola Electro valve
	Filtro separatore combustibili Fuel/water separator Filter
	Prefiltro Pre-filter
	Collettore gasolio Fuel manifold

7.6.1 Fuel inlet

The fuel intake of the yacht is equipped with a flow switch having the function to prevent undesired leaks of fuel from the plug and from the vent which may stain the bridge and pollute the water. The leak of fuel may occur during refuelling, if the tanks are almost completely full.

The fuel coming out of the intake duct is collected in a tank with suitable capacity, which, on its turn, will drain automatically into the fuel tank, through the return duct.

Also the flow switch is equipped with own air vent, bleeding from the wall near the filler plug of the tank.



CAUTION

The inlet plug carries the indication "DIESEL" to avoid accidental input of different fuels.

Filling lines pressure must be kept constantly under 0.3bar during bunkering operations.



CAUTION

Before refuelling, wash the teak with fresh water to avoid its contamination with fuel.



DANGER

During refuelling operations, do not approach open flames to the yacht; do not smoke. Carry out refuelling with engine shut off. The lack of consideration of these precautions can cause accidents and injuries.

7.6.2 Fuel quality

For the good performance of the engines installed on your yacht, fuel quality is of primary importance.

Fuel should be purchased from reliable high-sale filling stations, for both the quality and a probable short stay of fuel inside the shore tank.

The fuels:

- European Standard EN590
- DIN EN 590 (Germany)
- ÖNORM EN 590
- ASTM D975 No. 1D (USA)
- BS 2869 Part 1 Class A 1 (United Kingdom)
- BS MA 100 DMX (Marine Diesel Fuel)

are suitable to supply the engines.

If the above type of fuel is not available in some countries, follow the rules indicated in the manual relevant to the engines.



CAUTION

Stop all engines when refuelling.



WARNING

For the type of fuel to be used, follow the manufacturer's recommendations. Diesel engines require very clean fuel. Keep filters clean.



WARNING

If fuel containing water reaches the engines it can seriously damage the injection system. To avoid this, drain water from the fuel tank and service regularly the fuel/water separator filter.
During winter service do not use fluidity correctors.



CAUTION

We advise to drain and clean the tank periodically, at least once a year. Please remember that re-used fuel must be filtered.

7.6.3 Fuel system maintenance

Component	Maintenance	Notes and precautions
Fuel tank	Bleeding (at least every two or three refuelling and at least once a month)	As shown in the following sequence
Flow stopper	Fuel checks and cleaning	As shown in the following sequence
Water/fuel separator filters for engines	Maintenance and check Water drain from collection tank Replacement of filter element Troubleshooting procedure	As shown in the following sequence
Water/fuel separator filters for generators	Maintenance and water drain Replacement of filter element Troubleshooting procedure	As shown in the following sequence

Fuel tank:**Bleeding**

The tanks are equipped with a flametrap vent and with a visual check of the fuel level. The gauge includes a lower valve to be operated in order to display the real level in the engine room. The geometric shape of the tank allows the decantation of possible impurities or water in the fuel. For the drainage of water and possible impurities embarked with fuel, it is necessary to wait for some hours after refuelling, so that the suspended particles have enough time to settle down.

Drain through the opening of drainage valve located on the flange. To this aim take off the blanking plug from the valve, open the valve slowly and let the water and the deposits drain into a container, until only clean fuel comes out. After the operation close the valve, disconnect the hose and reinsert the plug. In addition to the venting valve, the fuel supply valves for the engines and generator are also installed on the flange.

During the long periods of inactivity of the yacht, when the tanks are empty, we suggest to open the flange and to remove the fuel deposits embarked during refuelling.

**WARNING**

The bleeding of tanks are a special operation, that has therefore to be carried out by specialized personnel. Contact the RIVA After Sales & Service Department to receive suitable help.

NOTE

The crew should always be present during this operation, as fuel leaks may occur in the engine room.

**WARNING**

During the tanks inner cleaning, it is a good norm, to ventilate the room for a long time with the help of fans and to wear all necessary protections, to avoid injuries caused by gas fumes.

During the flange assembly, make sure that the screws are correctly and uniformly tight, in order to prevent leaks of fumes and fuel.

Furthermore, check the condition of the O-ring.

These are extraordinary maintenance operations. Contact RIVA After Sales & Service Department in advance.

**CAUTION**

The draining should never be conveyed to the bilge. If the drained substances fall into the bilge, stop the bilge pumps immediately.

**CAUTION**

The bleeding procedure should be carried out every two or three refuelling operations.

**ENVIRONMENT**

Handle water mixed with fuel and dispose of it according to the rules in force. Use only authorized disposal procedures; in case of doubt, refer to the Port Authorities.

**CAUTION**

We advise to drain and clean the tanks periodically, at least once a year. Please remember that re-used fuel must be filtered.

**WARNING**

The bilges of the engine room must always be kept clean, so that fuel or oil leaks or penetrations from the engines or the generator can be easily noticed. If leaks are noticed, it is necessary to stop the engines and to let them cool and only afterward, if possible, repair the leak. Finally clean the bilges.

**ENVIRONMENT**

It is forbidden to discharge bilge water mixed with oil or fuel into the sea, as it can cause serious pollution. Periodically check the level of possible oily waters inside the collection tanks under the engines; should the level be next to overflowing into the bilge, disconnect the magneto-thermal of pumps of the bilge suction system, to prevent accidental spilling, until the bilge is empty, in compliance with current legislation for environmental protection. During the maintenance operation in the engine room, it is compulsory to disconnect the magneto-thermal of the bilge pumps suction system, avoiding in this way accidental spills.

MAINTENANCE

Check periodically the correct operation of the valves.
At least every three months check for the presence of leaks.
At least once every three months drain the tank.
At least once every two years carry out complete cleaning of the tank; check anyway the draining according to the quality of fuel filled.

Fuel flow stopper:**Fuel checks and cleaning**

Regularly check for the air outlet valve and clean the screen if necessary. At least each season begin and end carry out the following checks:

- Check for the anti-splash sleeve and replace if necessary;
- Check that pipes and connections are not leaking and install new pipes and/or clamps if necessary.

**CAUTION**

First place the filling nozzle as deep as possible into the filling pipe (through the rubber of the anti-splash sleeve), then use the nozzle to fill the tank.

**ENVIRONMENT**

Fuel is harmful to the environment. Prevent any spilling. Keep oil absorbent rags within reach as a precaution!

Water/fuel separator filters for engines:**Maintenance and check**

Purge frequency or the replacement of the filter element are determined by the contamination level of the fuel.

Water drain from collection tank

Check or drain the water collection tank daily.

The collecting tank must be drained before polluting agents reach the turbine end.

**WARNING**

If the engine has to carry on running, select the filter to be left in line and carry out maintenance on the other one.

This operation is a good procedure even if the engine is not running.

- After having placed a capacious collection container underneath it, open the drain to discharge containments.
- Remove the cover and fill with clean fuel.
- Close the cover and tighten the T-handle firmly by hand.

Replacement of filter element

Replace the element according to the time intervals recommended by the Manufacturer or if a power lack is noticed, which indicates namely that the element is clogged.

The current value varies according to the different fuel systems. Also extra elements like a tank too full or fuel excessively polluted can clog the filter.

- Remove the cover.
- Remove the element by holding the handle and by pulling lightly forward with a twisting movement.
- Insert a new filter having the same filtering features of the one replaced.
- Check and, if necessary, replace the filter cover gasket. Apply a layer of clean fuel or engine oil on the seal before reinstalling it, insert the new element with a slow twisting movement downwards.
- Fill with clean fuel, then replace the cover. Tighten the T-handle manually.
- Start the engine and ensure there are no leaks. Repair any leaks with engine shut off.

MAINTENANCE

At least once a month check the operation.

At least once a week, and anyway before each refuelling, check for the presence of water in the fuel.

If necessary drain the water present.

When necessary, but at least once a year, replace the cartridge of the filters.

Troubleshooting procedure

The main reason for a poor start-up or lack of power is the result of a clogged filter or of an air leak in the fuel system. If the device does not prime or does not hold the idle run, or air bubbles are visible through the check glass, first of all check the cover by means of the T-handle and vent it, if it had not been closed properly. Then check all connections and lines and make sure that no fuel line is clogged with contaminants. If the fuel tank is equipped with an incorporated filter, check for its possible clogging. If the problem persists and the filter element is new, address to RIVA After Sales & Service Department.

**CAUTION**

The separators have to be checked at regular intervals as suggested by manufacturer, so as not to impair the engines operation.

NOTE

For further information on use and maintenance, please refer to the manufacturer's manual.

Water/fuel separator filters for generator:

For maintenance of the generator filter, replacement of the filter part and the troubleshooting process, please refer to the procedure for the main engine filters in the previous chapter.

NOTE

For further information on use and maintenance, please refer to the manufacturer's manual.

7.7 THRUSTER SYSTEM

The thruster is a very simple and robust accessory, but it requires some attention:

- The thruster must be used at a very low speed, or without fresh way; at higher speed, more correct reactions can be obtained with the offset use of the gear boxes;
- Each time the yacht is lifted up, check the condition of each thruster, of the protection anodes and of the fastening system.

MAINTENANCE

At least once a week check the correct operation.
At least once every three months check the status of the anodes and if necessary, replace them.
When necessary top up oil.

Use of the thruster

Before using the thruster, the magnetothermal switch located on the electrical panel (24V section) on the access ladders in the lower deck must be activated.

Enable the relevant commands by means of the ON button on the joystick control panel.

A continuously on indicator light confirms readiness for use.

The propellers are controlled via the control joysticks.

The battery breaker is located on the bow side of the engine room.



WARNING

When the thruster is no longer in use, press the OFF button on the control panel.



CAUTION

In case it is necessary to replace a fuse on the thruster system, have this operation carried out by a skilled naval electrician. Take care to carry out a preliminary inspection of the relevant thruster technical operation documents or to contact RIVA After Sales & Service Department.



CAUTION

For the continuous operation of the thruster, refer to the manual delivered by the Manufacturer.



DANGER

During the thruster operation, pay attention to possible swimmers which may be close to the thruster openings.
Do not test the thruster when the yacht is outside water, unless you are sure the workers are at safety distance from the thruster tunnel.



CAUTION

When the bow thruster is not used, always disconnect the control unit.

**DANGER**

Always stop the thruster before undertaking inspection or maintenance tasks by disconnecting the switches and possibly also the battery terminals.

**CAUTION**

Never activate the thruster longer than one second when the yacht is at dry dock, because this can damage the electric motor seriously.

NOTE

For further information on use and maintenance, please refer to the manufacturer's manual.

7.8 OIL CHANGE SYSTEM

The oil change system consists of a reversible pump connected to oil-resistant rubber hoses.

Through this system it is possible to load/unload oil to the following uses:

- Main engines;
- Gearbox;
- Generator.

After connecting the pump to the appropriate connections, you can choose the operating mode by pressing one of the buttons on the pump.

Riva

56 RIVALE *supera*

STEERING SYSTEMS

CHAPTER 8

8.1 STEERING SYSTEM

The power assisted steering system has been designed to make steering easier during navigation and to improve the safety conditions of the system.

The yacht's wheels are connected to a mechatronic system that constantly acquires their real position. In the engine room, an electronically connected electro-hydraulic control unit drives the rudders by means of hydraulic cylinders.

The control unit is equipped with an automatic filling system which enables the oil to be poured directly into the tank of the control unit itself.

When the autopilot is activated, the system automatically switches to bypass mode, disabling all of its own signals, thereby allowing the autopilot to control the rudders.

NOTE

For further information on use and maintenance, please refer to the manufacturer's manual.

Steering system diagram:

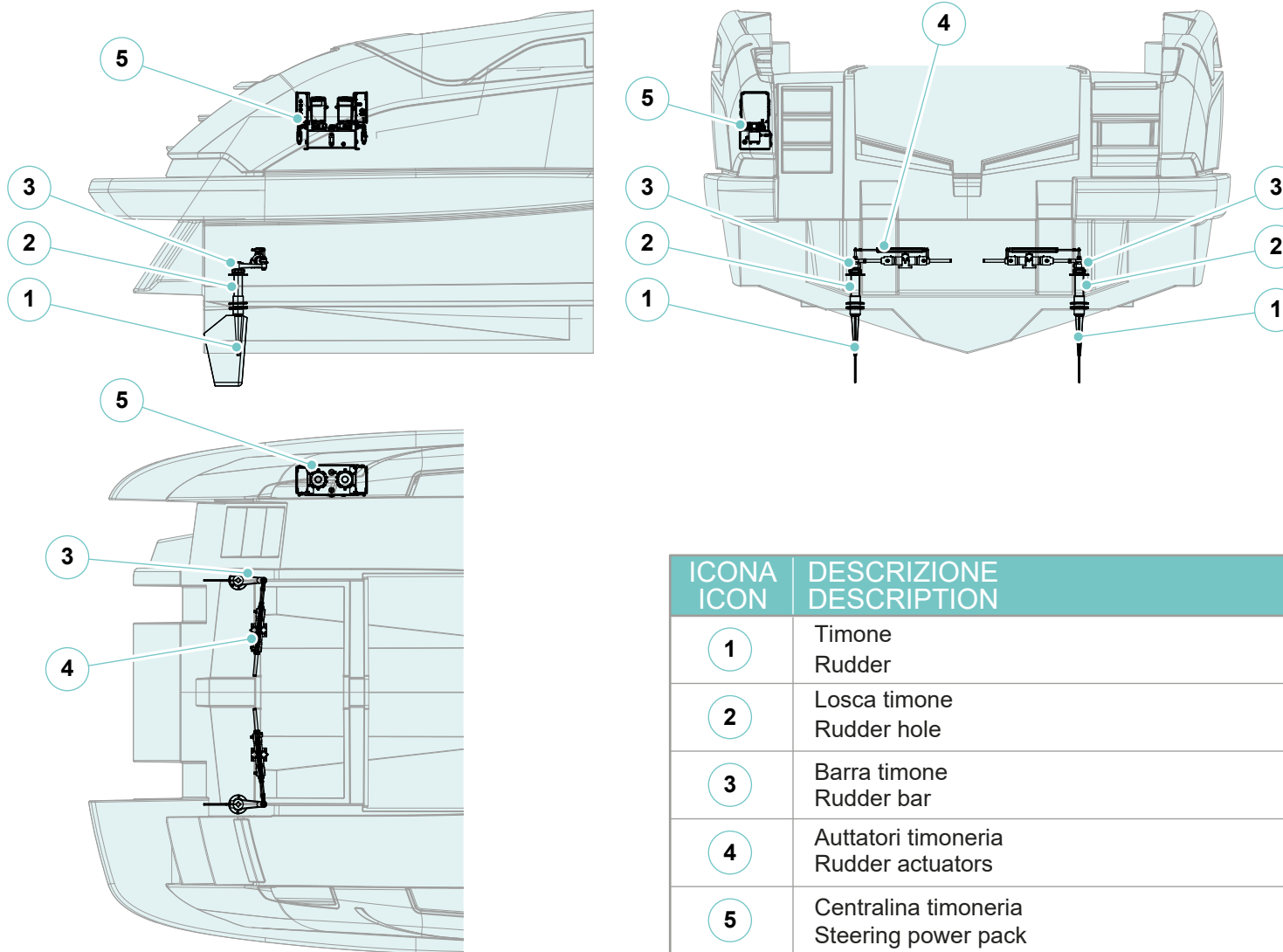

8.2 INTERCEPTORS SYSTEM

The yacht is equipped with two interceptors, which can be controlled from the helm station. Each interceptor is driven by an electric motor.

They allow you to vary both the yacht's longitudinal and transverse trim during navigation.

Familiarisation with the use of interceptors is important, as their correct use will improve performance and comfort.

In principle, lowering and raising the interceptors will lower and raise the bow of the yacht respectively.

Correct positioning of the interceptors results in a stable and ideal setup which can increase speed while reducing consumption.

In particular navigation conditions, when, due to lateral forces of the sea, sea currents and wind, the yacht assumes an inclined attitude, to restore normal conditions while maintaining the course, it is necessary to act on the wheel of the rudder or with the offset use of the interceptors.



WARNING

Interceptors are normally used during cruising, both to make it more comfortable and to achieve better performance of the yacht, according to the sea and navigation condition, and the yacht loading.



CAUTION

When using reverse, set the interceptors fully up otherwise they may be damaged.

A signal sent from the helm station to the electronic control unit located in the engine room activates the interceptor drive motor.

The motor rotates in the chosen direction and determines the interceptor inclination.

Pressing the button on the other position determines the opposite movement of the motor. Each button controls the movement of an interceptor.

The monitoring system provides a reading of the trim adjust inclination, measured by means of a position transducer fitted to each interceptor.

Some suggestions will be useful in familiarizing yourself with the interceptors:

- After the hull has moved to the glide position, adjust the position of the interceptors to find the angle most favourable to navigation;
- At high speed, it is advisable not to operate the interceptors simultaneously, one up and the other down, but to perform the operations separately to avoid sudden skids; instead, it is possible to manoeuvre them simultaneously in the same direction;
- In calm seas, the best position for interceptors is to allow maximum speed with less yacht drag;
- In rough "bow" sea, the "down" interceptors will allow you to "beat less" and sail with more comfort even if your speed will be reduced;
- In rough seas "on the stern", the interceptors "up" will tend to raise the bow thus avoiding unpleasant on her beam ends;
- With lateral wave motion or asymmetrical lateral load, the best stability is achieved with staggered interceptors;
- If the yacht is not in motion, place the interceptors all on.



CAUTION

The manual use of Interceptor, running at high speed, requires special attention and it is normally not recommended.

**CAUTION**

The interceptors, as well as transmission systems, can suddenly change the yacht direction if operated too rapidly or with high angles of incidence, especially with increasing yacht speed and during manoeuvres (as they are usually sized and optimized for intermediate speed).

**CAUTION**

As is good practice on a yacht, always make sure that passengers are seated before performing large adjustment manoeuvres on the interceptors, especially if you are navigating at high speed.

**CAUTION**

Periodically clean Interceptor to remove any corrosion that may affect their efficiency.

NOTE

For further information on use and maintenance, please refer to the manufacturer's manual.

8.3 GYROSCOPIC STABILIZER

To reduce the annoying effect of the wave-induced rolling motion, a system has been installed comprising a gyroscopic stabilizer capable of generating a rotation equal and opposite to that of the waves.

The system provides a remarkable reduction of the pitch both with the yacht stationary or during navigation with low energy consumption that does not impair the quality of life on board and does not affect performance.

Thanks to these important features, the device can also be kept on at night to allow a greater comfort by damping almost completely the annoying rolling motion.

The stabilizer devices are based on a well-known principle of physics: a gyroscope tends to maintain its vertical rotation axis, parallel to the acceleration of gravity.

When an external force attempts to vary the position of the stabilizer, such as roll caused by the movement of waves, the stabilizer prevents this action by rotating along an axis perpendicular to its own and that of the disruptive cause.

This generated operation (roll) is decreased by the presence of a damper specially calibrated according to the characteristics of each yacht.

The system consists of a stabiliser positioned centrally in the engine room, controlled by multifunctional display in helm station.



CAUTION

Have the scheduled PERIODIC INSPECTION performed by skilled personnel every two years.

Address to the RIVA After Sales & Service Department.



WARNING

During operation, the stabilizer, vibration dampers and their housing overheat. Touching the stabilizer during operation may cause burns.



DANGER

The stabilizer housing is not a solid component. If you place objects or sit on the stabilizer, the stabilizer may become damaged.



CAUTION

The stabilizer is not watertight. If it's submerged in seawater, it could be damaged.

MAINTENANCE

The gyroscope system is designed to require as little maintenance as possible. However, since the system is equipped with mechanical and electrical components for operation at sea, periodic checks and maintenance are recommended. The manufacturer recommends an annual inspection and maintenance interval every 2000 hours of operation of the gyroscope in the absence of failure.

NOTE

For further information on use and maintenance, please refer to the manufacturer's manual.

Riva

56 RIVALE *supera*

AIR CONDITIONING AND VENTILATION SYSTEM

CHAPTER 9

9.1 AIR CONDITIONING SYSTEM

The air-conditioning system consists of a heat pump air-conditioning unit fitted with an internal seawater heat exchanger that cools (or heats, in winter mode) freshwater in a closed circuit. This unit is used to cool water used as a thermal exchange with the air of the rooms to be cooled down.

In winter the inversion of the cooling circuit (by heat pump) allows the water heating instead of the cooling, in this way the rooms get warmed up.

The fresh water, by means of a circulation pump, delivers cooled (or heated) water to the fan-coils until it reaches the set temperature.



WARNING

Check that fresh water circulates regularly.

In the event of a pressure drop or of a long period of inactivity, stop the system and top up water through supply valve until the requested pressure is achieved, this will be indicated by proper pressure switch installed on the unit. After this, close the supply valve.

The entire system is powered by 230 VAC, and is controlled by a magneto-thermal switch on the engine room electrical panel.

The compressor unit is located in the engine room on the starboard side.

Each fan-coil is independent and is controlled by an associated control panel provided with independent temperature sensor.

Before starting the system, check the sea-water and circulation pumps for free rotation, by rotating the cooling fan of the electric motor with a screw-driver.

Rotation should be free, in case the pump is locked, do not start, but eliminate troubles first (dirt, rust, scraps, etc..).

Check that sea-water intake and outlet valves are both open.

Switch on the refrigerator by means of selector placed on the machine front side or on the separated electrical panel.

Check the correct rotation of sea water and treated water pumps, by looking at the arrow that is marked on the pump body.

It is advisable to check the power absorbed by the pumps and to compare it with the plate data.

The unit will work normally if the circulation of sea water and treated water is correct. After a few seconds the compressor will start.

At the compressor start the running light will switch on together with the hour meter.

Its operation will stop when reaching the temperature of chilled water 7 (45°F) to 8°C (46°F).

The temperature of the chilled water can be checked by suitable thermometers placed on the unit.

The cooled water temperature can be set by means of the thermostat on the unit's control panel.

The chilled water circulation pump will circulate water to the different fan-coils. Fancoils will exchange heat with surrounding ambient, the return water will be heated and the thermostat will automatically start the compressor, in a differential range of 3 (37°F) to 4°C (39°F), thus keeping the chilled water temperature in the range from 7 (45°F) to 11°C (52°F).



CAUTION

The excessive use of conditioned air may cause infirmities due to the great difference of temperature between the yacht inside and the outside.

**CAUTION**

Clean the strainer of the sea cock according to the time interval of the system use and to the pollution conditions of the sucked waters (seaweeds, mucilage's, etc..).

**CAUTION**

Before cleaning the strainer, remember to close the sea cock valve, to stop the generator and then proceed with maintenance.
Once this operation is finished, remember to open the valve which supplies the cooling circuit.

**CAUTION**

Make sure before every start of the system, which is the valve seacocks and those of the overboard discharge are fully open and check the cleanliness of the strainer.

**CAUTION**

Always leave the temperature sensors in each air-conditioned room unobstructed; obstructing them impairs the proper functioning of the system.

NOTE

For further information on use and maintenance, please refer to the manufacturer's manual.

Air conditioning system diagram:

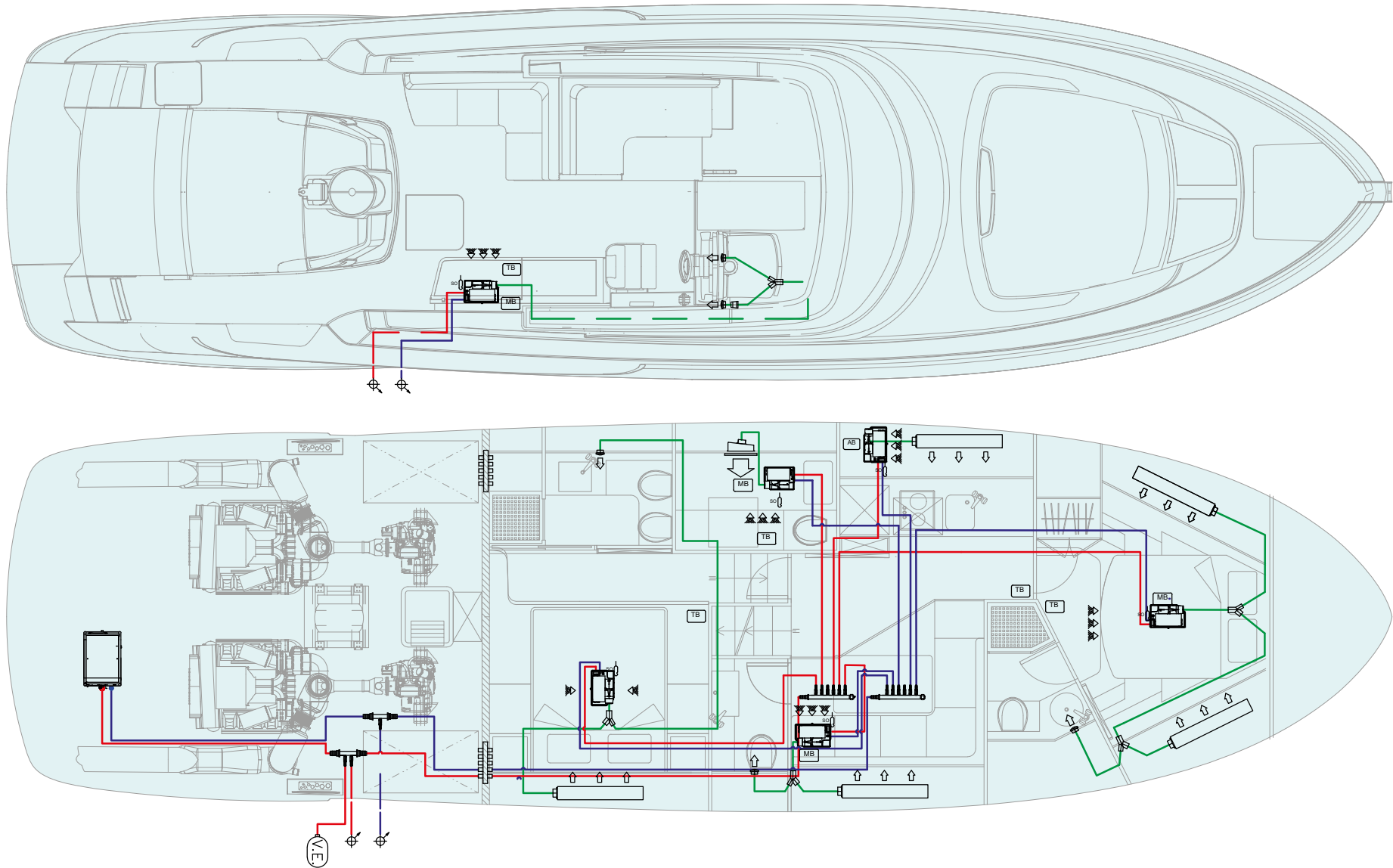

ICONA ICON	DESCRIZIONE DESCRIPTION
	Sonda temperatura Temperature probe
	Pannello regolazione sistema System control panel
	Scheda madre Motherboard
	Scheda fan coil ausiliari Auxiliary fan coil board

ICONA ICON	DESCRIZIONE DESCRIPTION
	Mandata fan coil Fan coil outlet
	Aspirazione fan coil Fan coil suction
	Dal ponte inferiore From lower deck
	Al ponte superiore To upper deck

9.1.1 Refrigerating unit control panel

The cooling system control panel located in the engine room has the following functions:

1. Alarm indicator
2. Program mode
3. Escape to exit
4. Scroll up
5. Enter
6. Scroll down
7. Display

At first start the chiller unit will operate according to the parameters set.



**CAUTION**

It is strongly recommended NOT TO CHANGE the factory setting. This is possible only in exceptional cases and with the help of RIVA After Sales & Service Department.

**CAUTION**

The signal of any alarm implies a failure in the operation of the system. INVESTIGATE and ELIMINATE THE REASON FOR THE FAULTY OPERATION before restarting the system. Refer to the specific manual or refer to the RIVA After Sales & Service Department.

NOTE

For further information on use and maintenance, please refer to the manufacturer's manual.

9.1.2 Fan-coil control panel

The fan-coil control panel located in each room, as shown in the air conditioning control diagram, has the following functions:

1. Room temperature detected
2. Active operating mode:
 - Heating
 - Electric heating
 - Cooling
 - Only fan
3. Fan speed. You can enter the operation selection menu by pressing on the symbol:
 - Auto
 - Manual
4. Fan-coil shutdown
5. Temperature reached. You can enter the operation selection menu by pressing on the symbol:
 - Cooling
 - Heating
 - Electric Heating
 - Ventilation only
6. Temperature setting buttons
7. Configuration button

NOTE

For further information on use and maintenance, please refer to the manufacturer's manual.

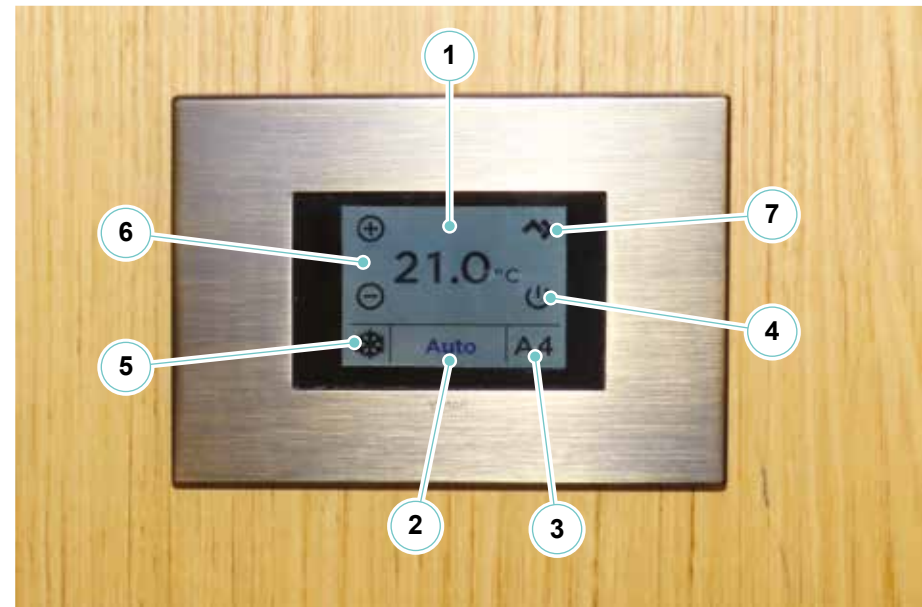

9.1.3 Air conditioning system maintenance

No delivery of cool or warm air from fan-coils

Lack of treated water in pipes. Check if the pressure gauge operates at the minimum pressure of 10 m with idle system. In case the gauge reads 0, most probably there are air pockets in the circuit or water leaks. Stop the system and fill water through a cock so as to reach a pressure of 10- 15 m. Purge air by means of the relevant valves installed on the heat exchanger, the fan-coils and the manifolds, keep the purge valve open. If the treated water flows regularly, and the outlet does not release warm or cold air, check if the fan turns and if the room thermostat is set to correct summer-winter position.

Fan-coils air setting

Each fan-coil allows setting three speeds and an automatic speed. Select the required mode.

Room temperature setting

To obtain the desired room temperature, set the thermostat to +21, +22°C / +70, +72°F in winter cycle and to +24, +25°C / +75, +77°F in summer cycle. Refer to the instruction manual.

Temperature check of treated water in the fan-coils circuit

The treated water temperature check is performed through two digital control panels. The water temperature inside the fan-coil circuit may vary from 0 °C/32°F +60°C/+140°F and by exactly the water temperature in the fan-coil circuit.

For a good BTU/h performance, the thermometer should indicate +7 + 8 °C/+45, +46°F in summer and +45°C/+113°F in winter after 15-20 minutes of operation.

When the set temperature is reached, the compressor stops, while the treated water pump keeps running.

The compressor starts automatically when water temperature decreases by 3°C/37°F in winter cycle or increases by 3°C/37°F in summer cycle. In winter, if the sea water temperature drops below +10°C/50°F, the heating output of the unit is seriously affected.

Sea water circuit check and cleaning

Check the strainer located on sea water suction periodically, specially when the yacht is shored.

Never leave water in the system when the yacht is out of water.

At least once a year, it is important to have the system rinsed with fresh water for half an hour, to remove all sea water residues.

Fan-coil cleaning

At least once every six months clean the fan-coils sucking the dust trapped in the back screen. Disassemble the filter, clean it, disinfect it and reassemble it; if broken, replace it.

Winter cycle

The units can produce hot water for heating purposes, by using the heat pump, reverse cycle principle. Just set selector on "Heat" and the unit will start producing hot water at about 45°C/113°F.

The selector acts on the solenoid valves for cycle inversion. In winter, the heating capacity of the unit depends on the sea water temperature; efficiency diminishes as sea water temperature grows colder.



WARNING

Pay attention not to damage the airtight cooling circuit.



CAUTION

The topping-up of the chilling liquid must be carried out by skilled and qualified personnel, according to the indications of the Manufacturer.



CAUTION

The air inlets of the air conditioning system must always be free; their obstruction beyond involving the system performance, can also generate serious problems.

9.2 ENGINE ROOM VENTILATION SYSTEM

The ventilation system of the engine room allows the necessary air recirculation for the operation of the propulsion systems and of the machinery installed on your yacht, so as to keep a safe temperature inside the engine room.

The ventilation system consists of two lateral air intakes, which let air enter in the room and prevent the penetration of sprinkled water and of two extractors, withdrawing the inside air and conveying it outside.

In case of emergency, the extractors can be stopped directly by activating the fire-fighting system in the stern cockpit.

To activate the air extractors, activate the magneto-thermal breakers located on the general electrical panel, 24V services.

The extractors may be activated in 3 ways:

1. Starting the engines (delay in switching off after they have been returned to OFF).
2. With manual activation from the main electrical panel or from the monitoring station.
3. From the engine room thermostat which activates the extractors when the local temperature exceeds the pre-set threshold.



CAUTION

While the engines are running, the extractors must always be activated. It is suggested to keep them on for at least 30 minutes, after anchoring, to eliminate the residual heat.



CAUTION

Do not place any type of tool or clothing on the extractors or in the air intakes, as this could damage the rotating parts of the electric extractors or obstruct the passage of air.



DANGER

Carbon monoxide poisoning

Fossil fuel combustion generates a high quantity of carbon monoxide. This gas is a colourless, odourless and highly toxic. When the engines and/or the generator are running, the yacht must be properly ventilated, in particular if underway at low speed, or when the exhaust fumes may blow back on board (e.g. when the yacht is shored or anchored or riding the anchor).



DANGER

It is strictly forbidden to insert your hands or tools inside the fan when operating or when electrically connected. Before starting the fan, make sure that this one is protected against tampering, in compliance with the laws in force.

Engine room ventilation system diagram:

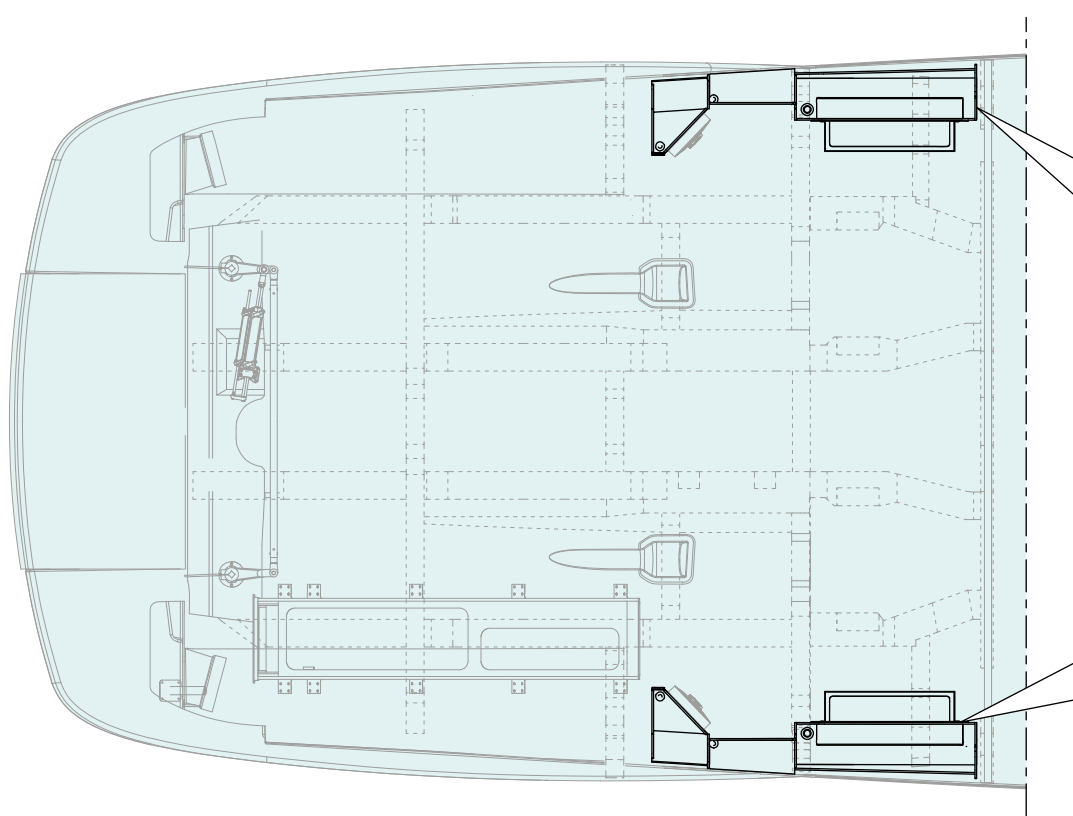

VISTA LONGITUDINALE
LATO SINISTRO
LONGITUDINAL VIEW
PORT SIDE

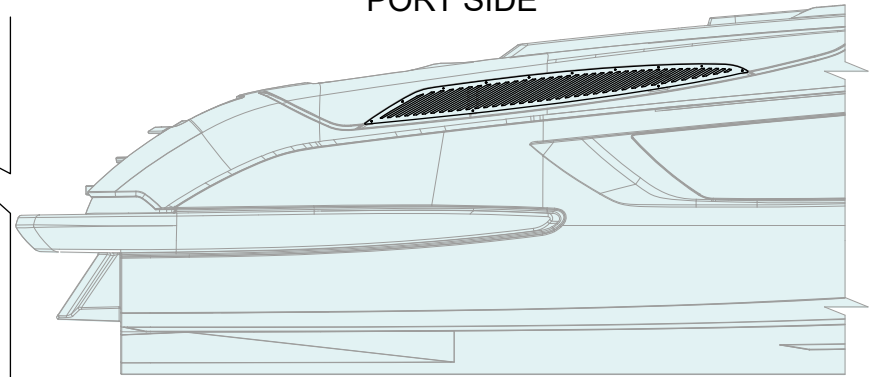

VISTA LONGITUDINALE
LATO DESTRO
LONGITUDINAL VIEW
STARBOARD SIDE

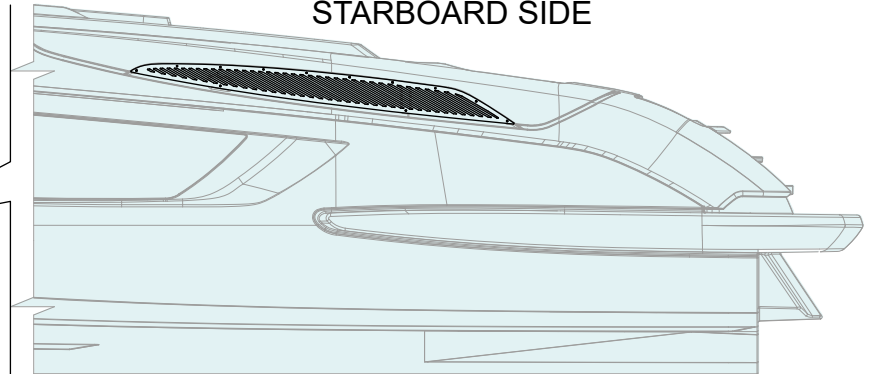

Riva

56 RIVALE *supera*

AUXILIARY EQUIPMENT ON BOARD

CHAPTER 10

10.1 MOORING AND ANCHORING ARRANGEMENTS

Your yacht is equipped with deck equipment necessary for easy and safe mooring.

In addition to the anchor winch, mooring equipment is located at the bow, on the walk-around and at stern of the yacht, and consists of cleats, fairleads and anchor windlass:

- Each stern mooring furniture is arranged with two cleats and a mooring winch;
- A cleat is arranged on each side of the walk-around of your yacht;
- On the stern platform, two pop-up cleats have been arranged (one on each side of the yacht);
- In the bow mooring area, there are two cleats, two rope guides and an anchor windlass.



CAUTION

Do not use the stern cleats as permanent mooring points of the yacht. They should be used only for the mooring of the tender or jet-ski. The stern cleats must never be used for the tender or chase boat towing.

Bow mooring:

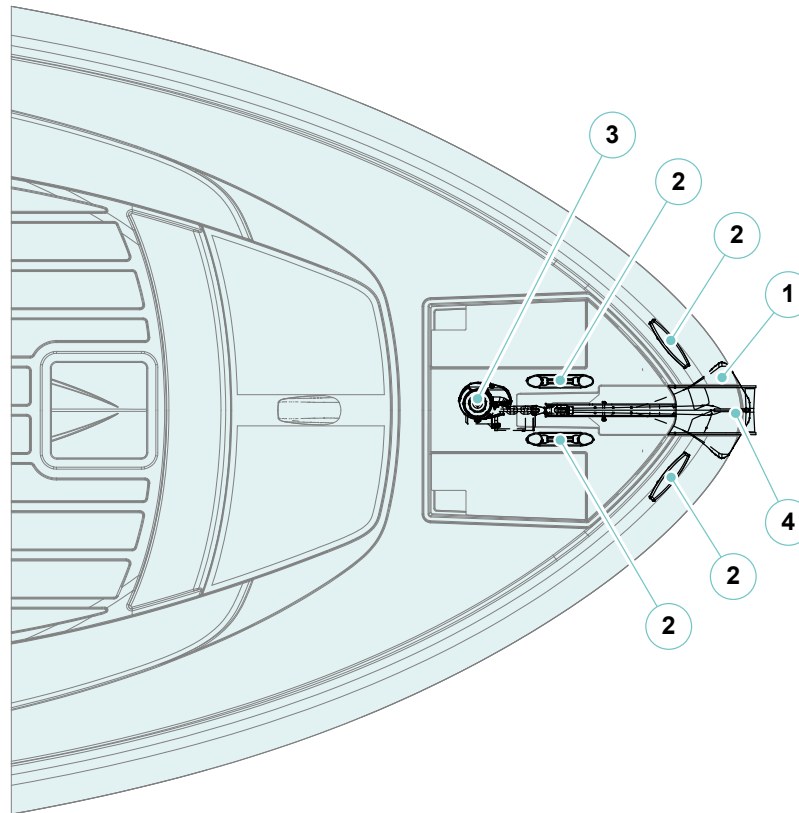

ICONA ICON	DESCRIZIONE DESCRIPTION
1	Ancora Anchor
2	Bitta Cleat

ICONA ICON	DESCRIZIONE DESCRIPTION
3	Verricello Winch
4	Passacime prua Bow fairlead

Stern stream:

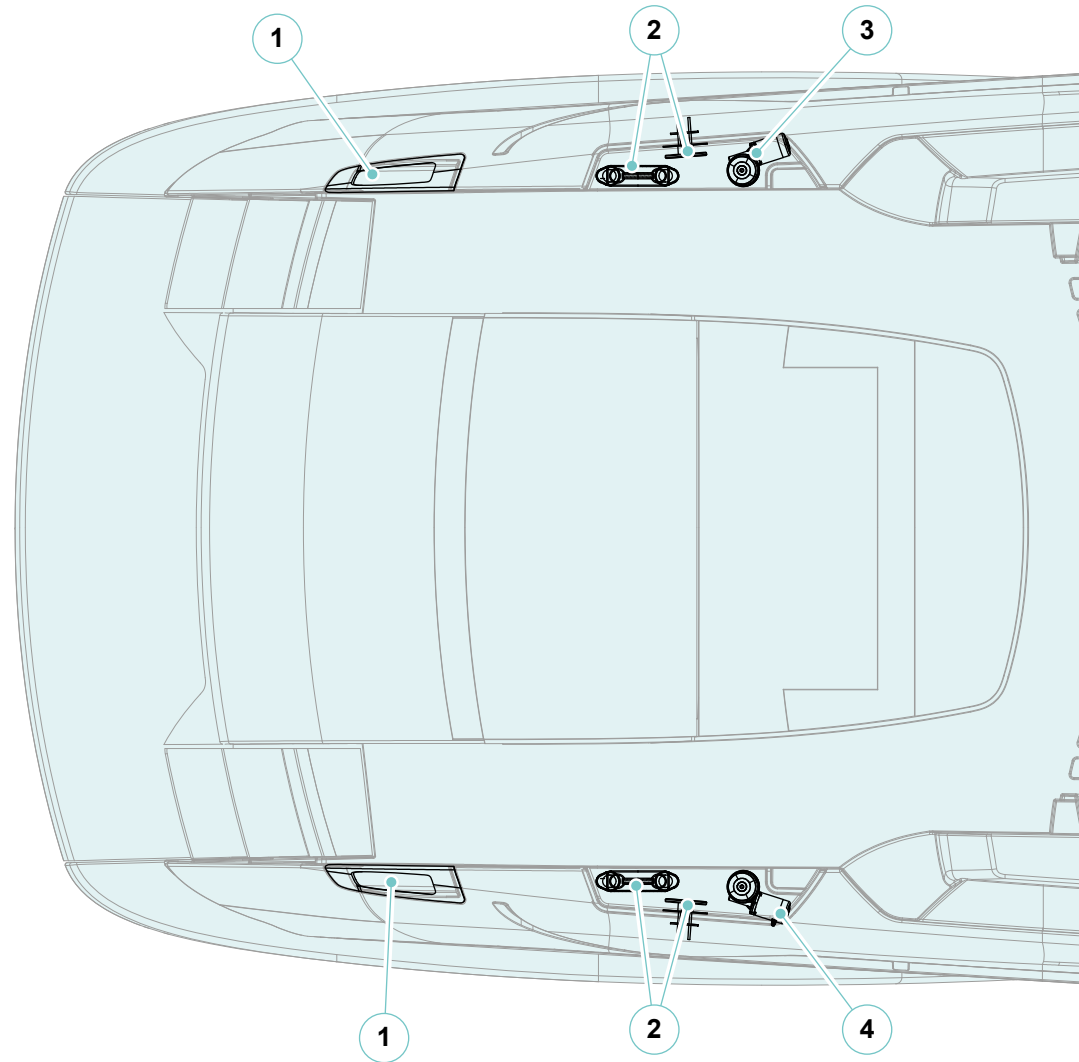

- 1. Rope guides
- 2. Cleats

- 3. Port winch
- 4. Starboard winch (optional)

10.1.1 Anchor winch

The yacht is equipped with an anchor windlass winch that moves the anchor housed in the bow.

The anchor chain enters the yacht through the hawsehole and reaches the windlass, rides over the gypsy and enters the chain locker.

The anchor winch is equipped with control for chain displacement in both directions and with manual brake to lock the chain during mooring.

The winch is equipped with a clutch separating the drive shaft from the wildcat; this allows using it as a warping winch for pulling a line.

The main parts of the anchor winch are:

1. Bushing for lever engagement

This device allows lever engagement.

2. Barrel

This device allows pulling a line.

3. Wildcat

This device allows weighing and lowering the anchor.

4. Wildcat locking wheel

This device allows locking the wildcat rotation for the chain fastening.

5. Lever

Adjusts manually the clutch opening and closing, and releases the wildcat.

6. Safety wire

This device allows locking the anchor chain.



CAUTION

RIVA is exempted from any liability for any accidents or damage to persons or property caused by incorrect use of the device.

Anchor winch activation controls

The winch, positioned in the bow, can be operated via the buttons located on the helm station.



CAUTION

If you wish to use the anchor, loose the wildcat lock and remove the safety wire.



CAUTION

Do not bring body parts or objects near the area where the chain, the line and the wildcat run. Make sure the electric motor is not powered when acting manually on the anchor winch (also when you use the lever to loosen the clutch): people having the remote controls of the anchor winch (remote push-button panel) might accidentally activate it.



CAUTION

Lock the chain with its safety cable before setting up for navigation.



CAUTION

Do not operate the anchor winch electrically with the lever in the drum housing or in the wildcat cover.

Clutch use

The wildcat is connected to the main shaft by means of the clutch. The clutch opens (disengages) when “the lever inserted in the bushing is rotated counterclockwise. When rotating clockwise, the clutch will close (engage).

Anchoring

The wind and the sea conditions highly affect an anchored yacht. Make sure the anchor is set in any situation. It is necessary to understand the principles of the chain length and its effect on the anchor performance.

The radius is technically defined as the ratio between the chain length and the vertical distance from the bow to the sea bottom.

The chain length depends on the type of anchor, on the sea bottom, on the tide, on the wind and on the sea conditions.

The chain length is 5 times the depth of calm sea; it is 7:1 in normal conditions and up to 10:1 in critical conditions.

$$\text{Radius} = \frac{\text{Chain length}}{\text{Bow height} + \text{water depth}}$$

as it is necessary to know the length of the chain to be used for mooring.

$$\text{Chain length} = (\text{bow height} + \text{water depth}) \times \text{radius}$$

Anchor weighing

Start the yacht’s engine. Make sure the clutch is engaged and pull out the lever. Press the control button available and start to weigh the anchor. If the anchor winch stops without any reason, the anchor might be stuck and therefore the anchor winch magneto-thermal trips, due to the effect of the effort. In this case, if after several attempts the anchor winch remains stuck, we suggest to manoeuvre the yacht to release the anchor.

Check the raise of the last metres/feet in order to avoid bow damage.

Anchor lowering

Lower the anchor by means of the electric controls or manually. To carry out this operation manually, open the clutch and let the wildcat rotate freely on its shaft and the chain fall into the water. To brake the anchor chain fall, turn the lever clockwise.

To lower the anchor electrically, press the control button at your disposal.

In this case the anchor lowering is perfectly controllable and the unrolling of the chain or of the line is regular.

Once the yacht is anchored, lock the chain with the safety cable.

The anchor and the chain may damage the yacht bow if the anchor winch is not operated carefully.

We suggest to carry out the operation by means of the remote control located near the anchor winch; this will allow checking the lifting and lowering speed of the chain and the entry and exit of the anchor shaft into the anchor roller. Namely during those operations, an excessive gliding of the chain or a wrong entry or exit of the anchor shaft from the roller may cause damages to the yacht’s bow.

**DANGER**

Do not use the on board auxiliary equipment for aims or ways other than those indicated in the manual delivered by the Manufacturer.

Always disconnect the warping winches not in use, to prevent accidental activation.

**DANGER**

Never get too close to moving parts to avoid danger and injury.

**CAUTION**

The anchoring area is a circle with the centre at the anchoring point and a radius equal to the chain length plus the yacht length.

The entire anchoring area must be free, in case of sudden variations of wind and/or current direction, especially in case of night anchoring.

At night, before dropping the anchor, check that the white anchor light works.

Before dropping the anchor, check the nautical charts: anchoring is prohibited in certain areas, in weeds covered sea bottom, anchoring is unsafe and harmful to the environment, on rocky sea bottom, the anchor may get stranded or lost.

Anchor the yacht with the engines running, both for safety reasons and to compensate the electrical consumption of the winch.

Check the anchoring point frequently.

The distance from obstacles or other yachts must be, at 360°, greater than the length of chain dropped.

During anchor riding it is advisable to leave the winch powered.

Do not reverse the winch rotation suddenly.

**CAUTION**

The anchor chain is fastened to the yacht by means of a line and an hook system. If it is impossible to remove the anchor from the sea bottom, this system will ease up to resume navigation.

**DANGER**

When the winch is operating, be extremely cautious of rotating parts; keep your feet, hands and the remote control cable at safe distance.

Anchoring operations

- Make sure that the engines battery breaker is on;
- Turn the anchor winch switch ON, on the main electrical panel;
- When the key-pad is not used, disconnect it to prevent contact oxidation;
- Before operating the anchor winch with the electric control, check that the wildcat clutch is properly engaged and remove the wildcat stopper and the safety wire;
- Let the yacht move backward slowly; if necessary, use the engines;
- Lower the anchor until just below the waterline, and hold;
- Lower the anchor until it reaches the sea bottom;
- Once the anchor holds, leave the lock and the brake engaged.

**CAUTION**

Operate the anchor winch with the engines running, in order to provide the high current required and reduce the stress by slowly moving the yacht toward the anchor.

Lower and raise the anchor always by using the electrical control, after engaging wildcat and barrel. This latter can be disengaged both for casting off the anchor in case of need and to operate the barrel as a warping winch.

**CAUTION**

During navigation, make sure that both the chain stopper and the chain brake are securely locked.

Weighing the anchor

To weigh the anchor, perform the same operations previously described above, in reverse order.

In windy or strong current conditions, start the engines and keep the bow toward the anchor position to avoid the breakage of the chock.

Once the anchor is on board, fasten the chain stopper before resuming navigation.

**CAUTION**

Prior to departing, check that the chain stopper is properly fastened.

10.1.2 Anchor winch maintenance

Component	Maintenance	Notes and precautions
Reduction motor	Check and cleaning (before each navigation)	When you weigh the chain, after an anchor mooring in a muddy or weedy sea bottom, we advise you to wash the chain using the proper system. The outer part of the winch requires frequent washes with fresh water because very much exposed to sea salt during navigation specially with choppy sea.

Reduction motor:

We strongly recommend to separate the anchor winch from the main deck at least twice a year to remove the salt deposits building up under the base.



CAUTION

Before carrying out any maintenance operation on the anchor winch cut out electric power connected with it and remove with care the chain from the wildcat.

Remove the layer of salt, which builds up on the anchor winch outer surfaces as soon as possible, to avoid dangerous corrosion, which could jeopardize its integrity.

Wash with fresh water and clean the surfaces, particularly those hidden and hardly reachable and into which the salt remains trapped.

At least once every two months disassemble the exposed parts, clean and check all pieces so that they do not show signs of corrosion and grease the thread of the shaft with sea grease.

In case of anchor winch long inactivity, we advise you to have the motor run idle for a couple of minutes in both directions.

If the electric motor turns with problems we advise you to clean or replace the brushes.

10.1.3 Mooring winches

At stern, inside each mooring locker, a mooring winch installed on the side. For their operation it is necessary to wind the line into the barrel and to operate the foot button.

The foot buttons for each winch are located at the base of the relevant mooring locker and can be activated by pressing them with one foot:

- BLACK: recovers the line;
- RED: releases the line.

Near the mooring winches two mooring cleats are fitted.

For a safe anchor mooring, the lines used for warping have to be fastened to the proper cleats.

**DANGER**

Do not approach your hands to the sliding area of the mooring rope.

10.1.4 Mooring winches maintenance

Component	Maintenance	Notes and precautions
Reduction motor	Check and cleaning	For a correct maintenance and check refer to instruction manual delivered by the Manufacturer.

Reduction motor

Check and cleaning



DANGER

Before carrying out any maintenance operation on the anchor winch cut-off the electric power connected with it and remove with care the chain from the wildcat.

The winches are made of materials resistant to sea environment: it is necessary, in any case, to remove periodically the layer of salt which forms on the outer surfaces, to avoid dangerous corrosion, which could jeopardize its integrity. Wash accurately with fresh water and clean the surfaces, particularly those in which salt remains trapped. Disassemble the barrel according to the service intervals recommended by the Manufacturer.



CAUTION

Do not activate electrically the winch with lever inserted into the drum.



DANGER

Do not bring body parts or objects near the area where the rope runs. Make sure that there the electric motor is not powered when manually operating the winch.

MAINTENANCE

At least once a week:

- Check the operation;
- Wash with fresh water and carry out an accurate cleaning.

At least once every six months grease the terminals of the electric motor.

At least once a year disassemble and check the exposed parts.

10.2 GANGWAY SYSTEM

The gangway is controlled by a multifunction hydraulic power unit positioned in the engine room.



CAUTION

Use and suggest to passengers comfortable shoes and eventually help them with the boarding.



CAUTION

Never use slippery products for the gangway cleaning.



WARNING

Never jump on the gangway.



DANGER

Never use the gangway to lift persons, even though the same is provided and tested to lift high loads.
Always make sure that the maximum load suggested by the Manufacturer is not exceeded.



CAUTION

Always pay the utmost attention to the movements of the gangway.
In case of emergency, press any button of the remote control or of the panel to stop the gangway.

Gangway handling:

The gangway is housed on the starboard side of the engine room and comes out of stair which gives access to the stern cockpit, through the opening of a stanchion step.

The gangway handling is power steered and allows extending or retracting it. Once the gangway has been extracted, it is possible to lift or to lower the free end in order to adapt its trim to the shore height.

Gangway controls

The control panel for gangway handling is located in the stern cockpit.
The operations are to be performed by keeping the relevant panel button pressed. The gangway can also be operated from the radio remote control.



DANGER

Never operate the gangway when someone is passing nearby.
When walking on the gangway, be cautious and keep hold to the handrail; as it is made of rope, it cannot be considered a rigid and safe support, but simply a help to keep balance.

**DANGER**

Never start navigation if the gangway is not correctly retracted. Make sure that the gangway, the garage hatch and the swim ladder are correctly closed, before undertaking the navigation.

**CAUTION**

The hydraulic gangway, even if easy manoeuvrable, might damage people and things. Its use is recommended only to well experienced people.

**DANGER**

Be careful of moving parts and hands.

MAINTENANCE

At least once a week carry out the washing with fresh water and an accurate cleaning.

At least once a month:

- Check the oil level in the control unit, when necessary top-up;
- Check the possible presence of oil leaks and bleeding;
- Check the operation of the emergency pump;
- Check the possible presence of corrosion;
- Grease the pulley gliding races of the steel cable.

At least once every six months:

- Grease the swivel pins and the gliding sleeves;
- Tighten the locking bolts.

**CAUTION**

Always check for the correct gangway position from the shore.

**CAUTION**

Position the gangway in such a way that it cannot touch the shore, either because of the normal yacht swinging or of the tide change. Should the gangway strike against the shore, it could get seriously damaged.

**CAUTION**

Do not use the gangway as a springboard.

**CAUTION**

To avoid compromising the seals, perform the wash, avoiding that in the box enters water pressure.

NOTE

For further information on use and maintenance, please refer to the manufacturer's manual.

Gangway arrangement system:

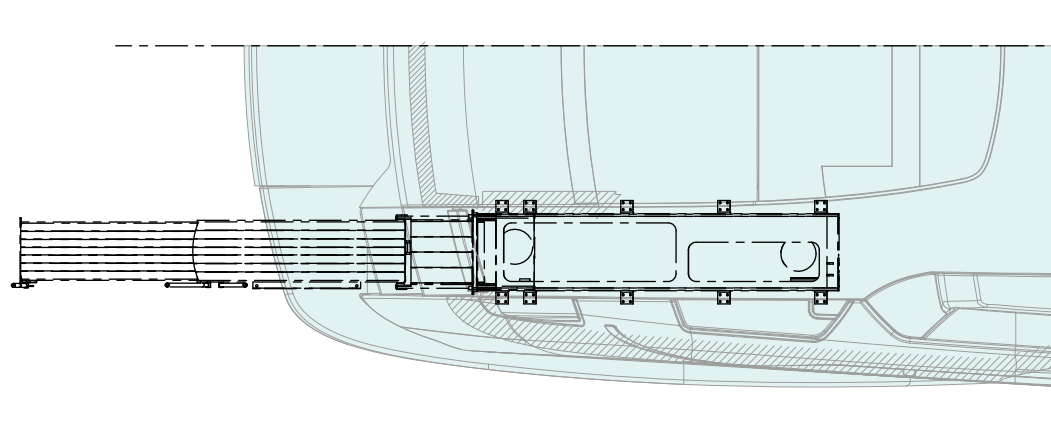
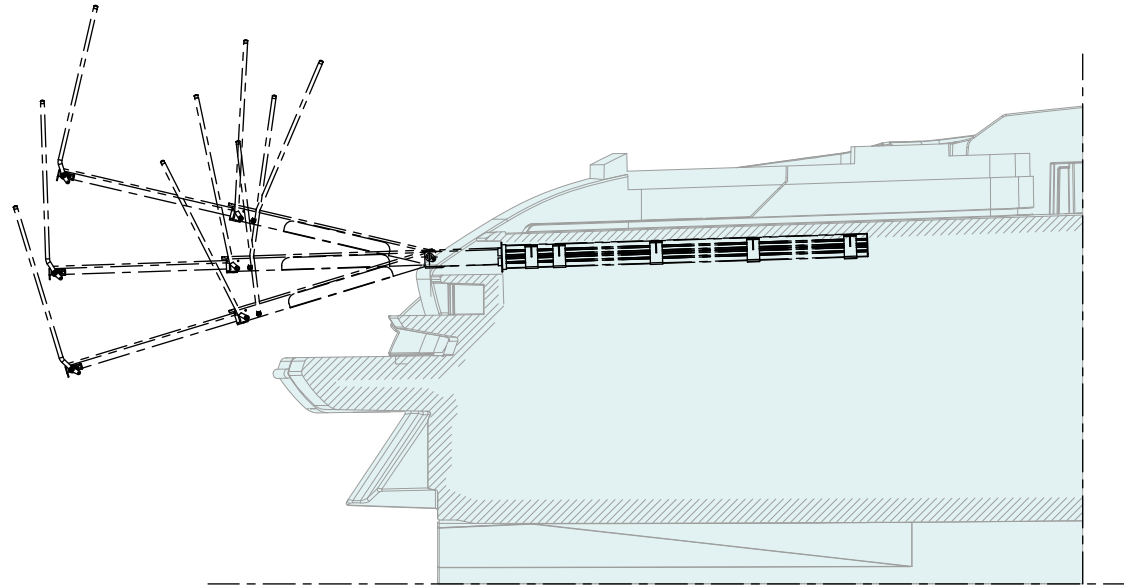
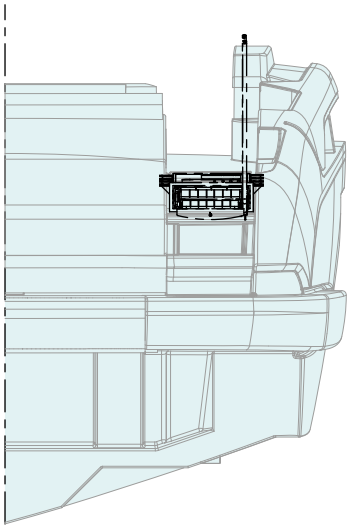

10.2.1 Gangway systems maintenance

Component	Maintenance	Notes and precautions
Gangway control unit	Oil check and top-up	Check monthly and always before each navigation the oil level inside the tank. Top up keeping the oil level at about three-quarters of the tank's capacity, and using the type of oil recommended by the Manufacturer.

10.3 SWIM LADDER SYSTEM

The yacht is equipped with an extractable ladder controlled by a multifunction hydraulic control unit that allows easy access from the sea to the aft platform, and vice versa.

The swim ladder is placed inside the structure of the stern platform on the starboard side, so as not to cause any hindrance during navigation, mooring and unmooring operations.

To make access to the sea more comfortable, two grab bars have been installed on the stern platform, inserted in special seats.

Swim ladder controls

The swim ladder movement control panel is located in the aft cockpit, starboard side.

The buttons are used to move the swim ladder out of its housing up to the stop, and to return it again.



DANGER

Never use the swim ladder while the engines are running. Caution must be used to avoid approaching the interceptors and propellers as they may be accidentally operated.



CAUTION

Make sure of the correct exit and position of the swim ladder before going down into the water.

The warning light on the push-button panel indicates that the swim ladder has come out of the stowage position inside the platform.



DANGER

Never navigate with the swim ladder incorrectly stowed.



CAUTION

Pay attention because the ladder can be slippery. Secure the grip before starting the return on board.



CAUTION

The swim ladder, while easy to manoeuvre, may cause damage to people and property. Use by sufficiently experienced personnel is recommended.



WARNING

To use your yacht safely, always open the swim ladder when you are off and alone on board.



DANGER

Risk of electric shock from leakage currents. Do not swim in water ports or marinas.



CAUTION

Do not use the swim ladder as a springboard.



DANGER

Pay attention to moving parts and hands.

10.3.1 Swim ladder maintenance

Component	Maintenance	Notes and precautions
Swim ladder	Outer cleaning	The swim ladder is in a special position compared to all the other equipment on board, as it is in constant contact with water, salt and exhaust fumes and therefore requires more thorough cleaning.

**DANGER**

During cleaning or maintenance operations, make sure that nobody can activate the gangway, the swim ladder and the garage hatch, because they could cause serious injury to people; it is recommended to disconnect the power supply.

MAINTENANCE

At least once a week clean with fresh water and a thorough cleaning.

At least once a month:

- Check the oil level of the control unit, if necessary top up;
- Check for leaks and leakage of oil;
- Check for corrosion;

At least 1 time every 6 months:

- Grease the joint pins and sliding sleeves;
- Tighten the anchor bolts.

10.4 GARAGE HATCH SYSTEM

The yacht aft section encloses the garage, capable of housing a tender and a tender.

The garage is accessible through the opening of an electro-hydraulic hatch. The controls to operate the hydraulic cylinders that raise and lower the garage hatch are located in the aft cockpit.



DANGER

The garage hatch must always be closed during navigation.



DANGER

Never start navigation with the garage hatch not correctly closed.



DANGER

Loads inside the garage must be secured with the greatest care.



DANGER

Leaking fuel can create a risk of fire and explosion.
No combustible or other flammable material may be stowed in the garage.



DANGER

Before closing the garage hatch, make sure that the tender has been completely closed and blocked.

Garage hatch controls

The garage hatch operation controls are located in the aft cockpit. The hatch is opened and closed by holding down the respective button on the panel.

The movement is obtained thanks to an electro-hydraulic control unit (24V) located in the engine room, which moves two hydraulic cylinders that raise and lower the garage hatch.

Press the relevant button in the cockpit to switch on the garage lights.

NOTE

For further information on use and maintenance, please refer to the manufacturer's manual.

Garage hatch moving system diagram:

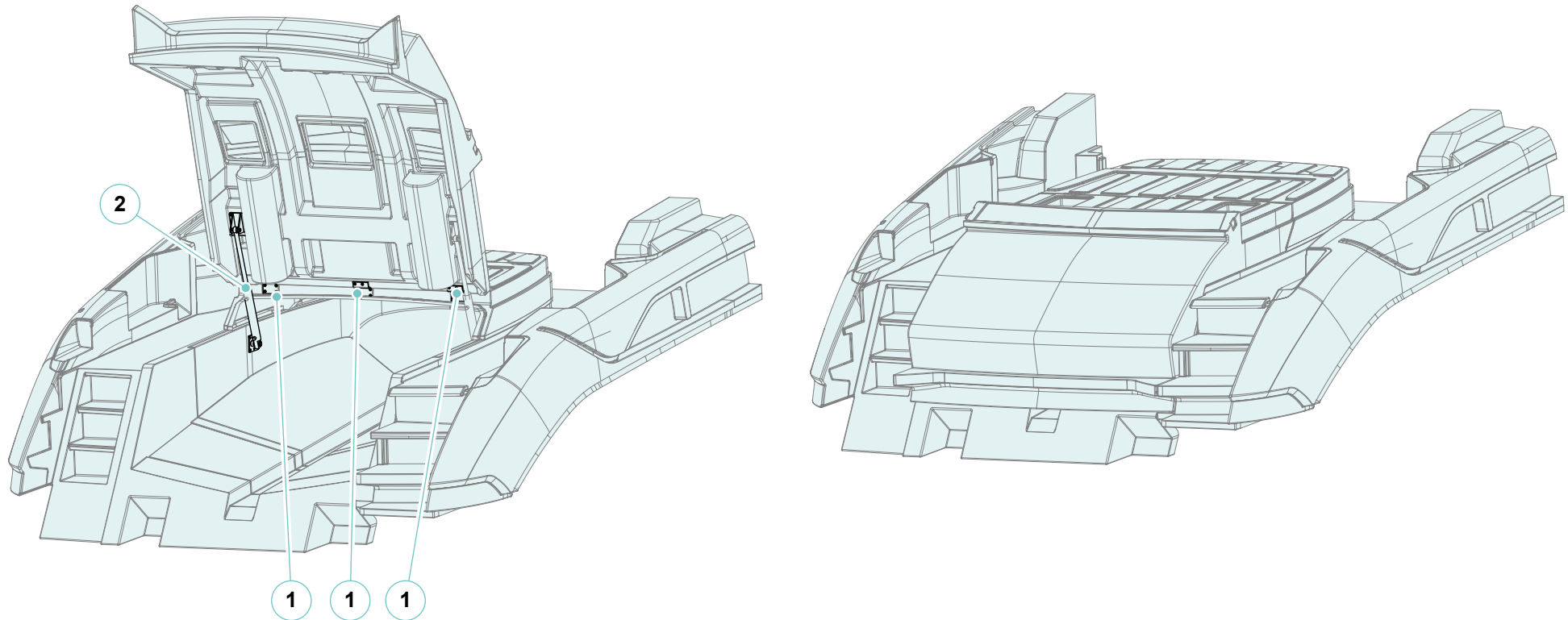

ICONA ICON	DESCRIZIONE DESCRIPTION
1	Cerniera portellone di poppa Stern door hinge
2	Movimentazione portellone di poppa Stern door movement

10.5 STERN PLATFORM SYSTEM

There is the platform that allows the launching or hauling of a tender, at the stern of the yacht, once the garage hatch is open.

The stern platform is operated by the electro-hydraulic control unit (24V) located in the engine room.

The control panel for operating the stern platform is located in the aft cockpit.



CAUTION

Do not use the stern platform cleats as permanent mooring points of the yacht.

They should only be used for the tender mooring.

The stern platform cleats must never be used for the tender or chase boat hauling.



CAUTION

Keep the platform lowered only for the time necessary to launch or haul the tender.



DANGER

Never cruise with the stern platform lowered.

This prohibition is also valid for low-speed manoeuvres.



DANGER

It is forbidden to:

- Move people with the stern platform;
- Lower the stern platform in unfavourable weather conditions;
- Leave the stern platform lowered when the yacht is unattended or in unfavourable weather conditions.

NOTE

Switch OFF the stern platform system magneto-thermal during navigation.

Stern platform system diagram:

LIFT SU - GARAGE CHIUSO
LIFT UP - GARAGE CLOSED

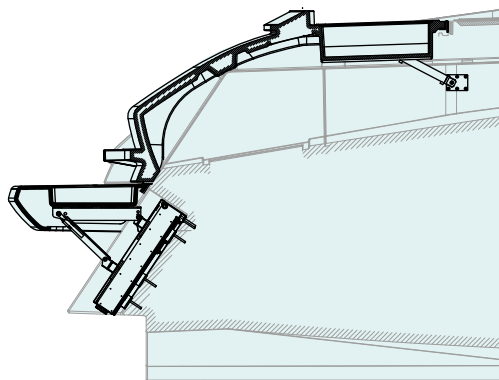

LIFT BEACH - GARAGE APERTO
LIFT BEACH - GARAGE OPEN

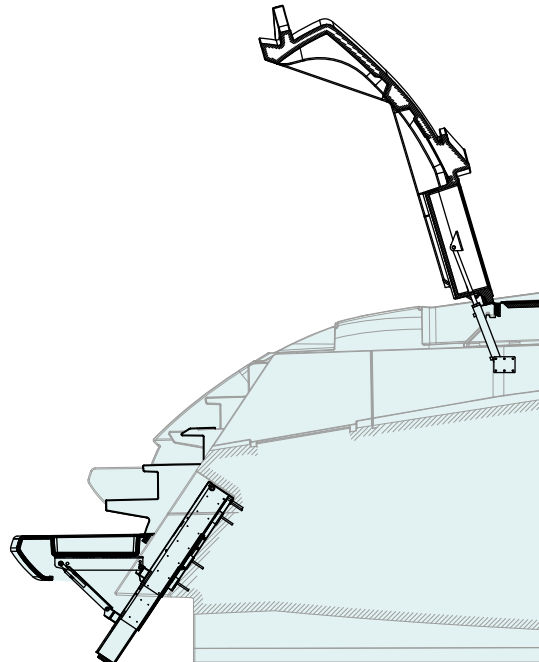

LIFT GIÙ - GARAGE APERTO
LIFT DOWN - GARAGE OPEN

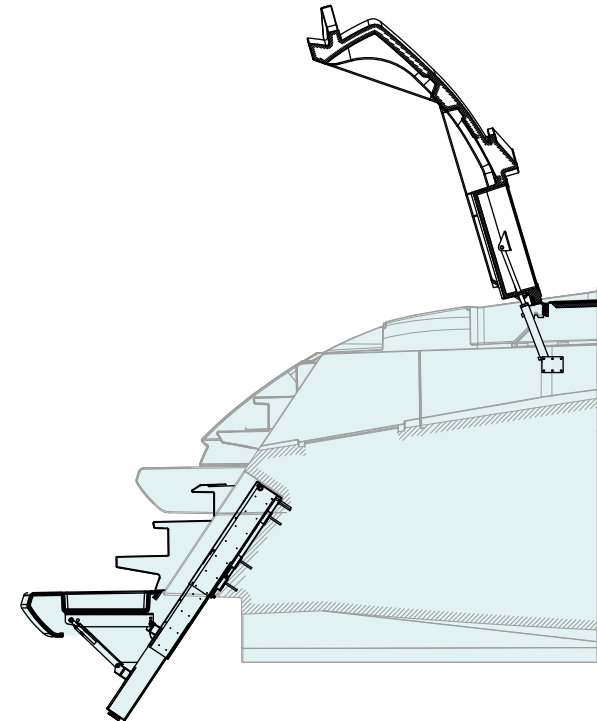

Stern launching diagram:

TENDER DENTRO
TENDER IN

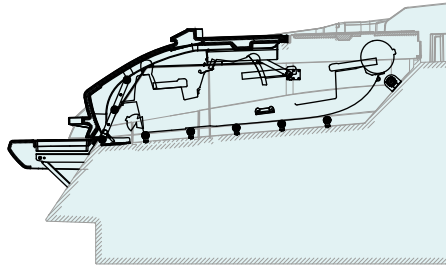

TENDER FUORI
TENDER OUT

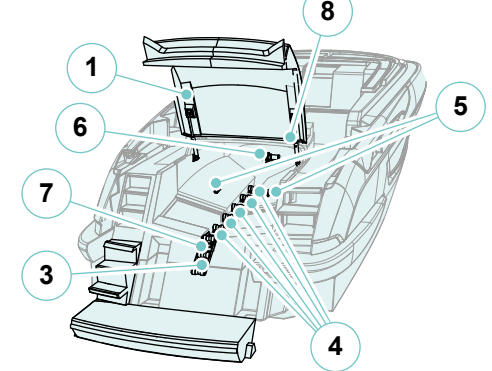
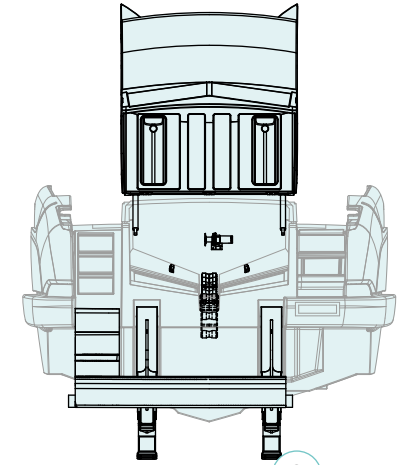
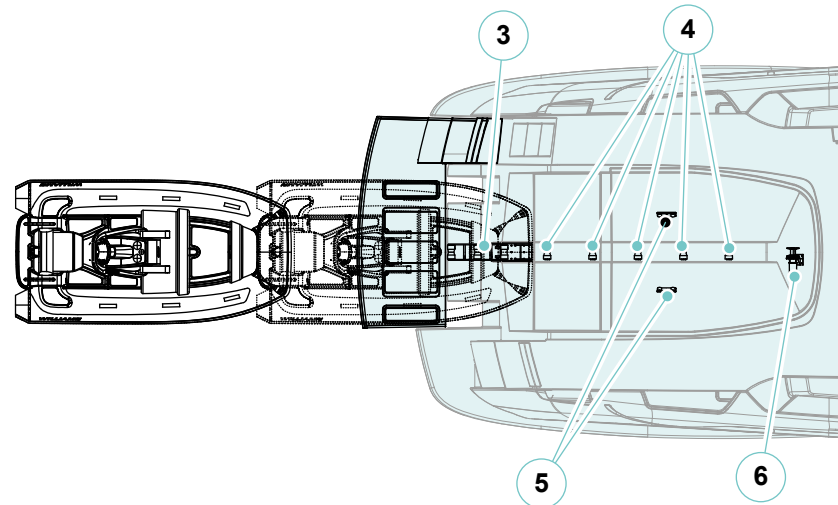
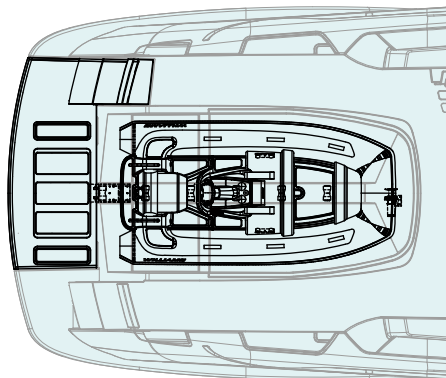
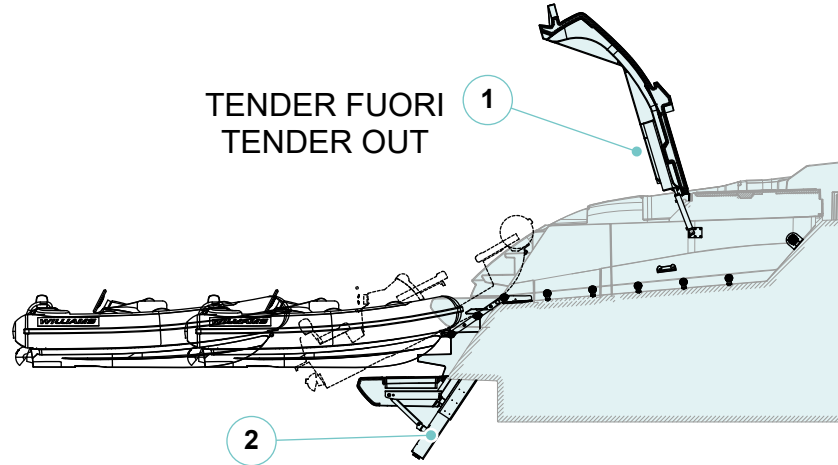

- 1. Stern garage hatch opening pistons
- 2. Tender lift
- 3. Folding rollers
- 4. Central roller for tender hauling

- 5. Tender keel roller
- 6. Winch
- 7. Teflon plate
- 8. Stern garage hatch hinge

10.6 WINDSCREEN WIPER SYSTEM

In order to ensure a sufficient visibility under any weather condition, your yacht has been equipped with an efficient windscreen wiping system. The system is supplied at 24V and allows activating, by means of mechanical brackets and at variable speed, the two windscreen wipers. The windscreen wiper system is controlled by the relevant push buttons located in the helm station.

1. **ON**: wipers button activation
2. **SPEED**: wipers button speed adjustment
3. **WASH**: washer button activation

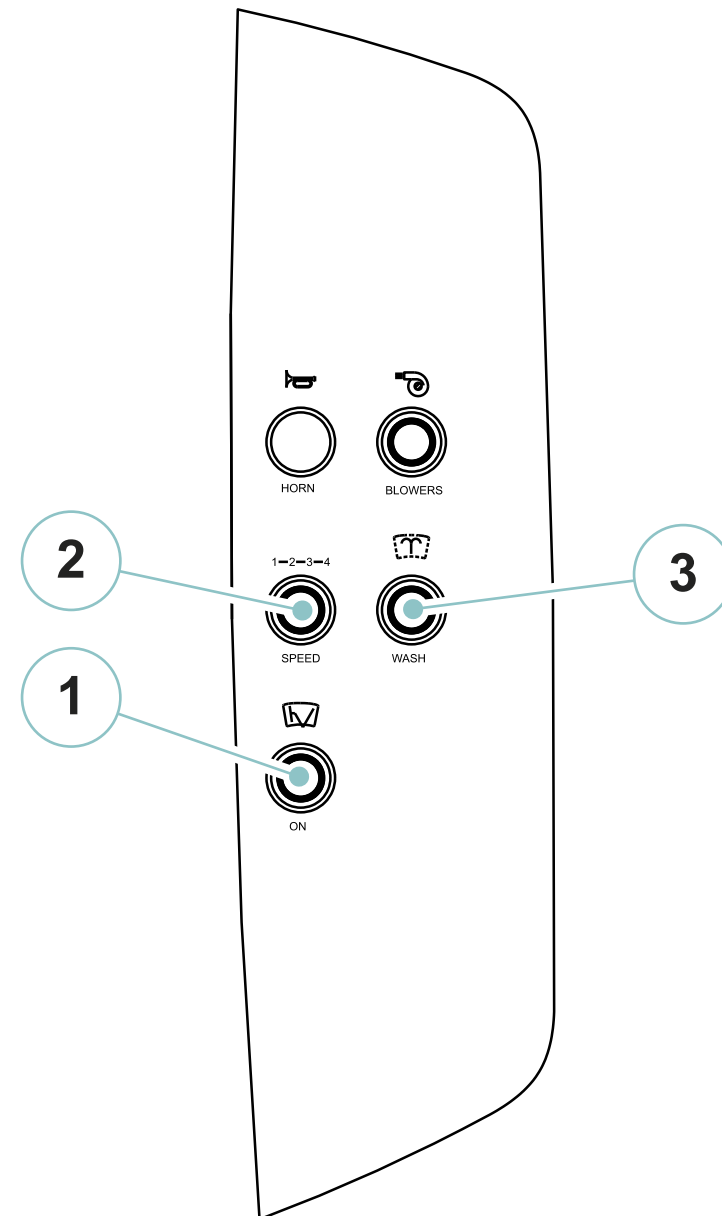

10.6.1 Maintenance of the windscreen wiper system

Component	Maintenance	Notes and precautions
Windscreen wiper blades	Cleaning	Clean accurately with fresh water after each navigation return. Clean periodically the windscreen wiping blades using specific detergent or alcohol. Apply Vaseline oil on the blades and grease the arms springs with silicone grease.
	Replacement	Replace the windscreen wiper blades at least once a year with original spares. If necessary and if the blade rubber results to be deformed or worn out, replace them more frequently.
Windscreen washer	Cleaning	If the screen washing system does not work or has a poor performance, check that the supply circuit of the nozzles is not clogged. In such a case, clean the spray holes with a needle.



WARNING

During the cleaning or maintenance operation, make sure that nobody can operate the windscreen wiping system causing damages to persons.



CAUTION

Do not remove foreign bodies activating the blades when the windscreen is dry.



CAUTION

With very harsh weather, and with the freezing risk, detach first the wiping blades from the windscreen surface.
Before activating the windscreen wiping system make sure that ice has not stuck the blades on the windscreen surface; if necessary to spray an anti-freezing agent to detach them.

10.7 BIMINI

Your yacht is equipped with an electrohydraulic bimini to provide shelter for the cockpit area.

The electrohydraulic unit that controls bimini movement is located in the engine room on the port side.

To open/close the bimini, activate the relevant circuit breaker located on the 24V electrical panel in the engine room.

The bimini is moved by pressing and holding the button on the helm station; movement is accompanied by an acoustic signal.

NOTE

Do not use products containing solvents to clean the bimini canvas as these may compromise the canvas surface treatments.

NOTE

The function of the bimini is to provide protection from the sun; remove any water deposits that may form on the bimini immediately. Any water remaining between the mounts for an extended period of time can cause dirt and the permanent deformation of the fabric due to the added weight.



CAUTION

During bimini positioning, guests must remain seated on the sofas of the cockpit to avoid the possibility that any loss of balance might lead them to grab parts of the bimini not designed to resist abnormal stresses.



DANGER

During the opening / closing phase, the captain must take care to ensure that guests are not present in hazardous areas, particularly within the bimini's range of motion.



DANGER

Release the bimini completely by holding down the appropriate button and stop only in case of emergency or hazard.



DANGER

Be careful not to place hands in the bimini cavity during closure.



CAUTION

Never open the bimini during navigation.
Only open when the yacht is stationary so as to avoid a "sail effect", which could damage the structure or cause injury to persons.
Do not open the bimini in adverse weather conditions.



CAUTION

Never press the bimini closing button without removing the fore and aft fastening straps.



CAUTION

When washing the yacht, never direct high-pressure water jets onto the canvas surfaces as doing so may deform the seams.

NOTE

For further information on use and maintenance, please refer to the manufacturer's manual.

Riva

56 RIVALE *supera*

INFORMATION FOR USE

CHAPTER 11

11.1 GENERAL INFORMATION

This part of the manual describes some basic rules to always keep in mind:

- Periodically check the availability and efficiency of individual and collective safety equipment.
- Keep a safe distance.
- Check that all yacht safety equipment on board is in good condition and no maintenance activity is overdue.

NOTE

The manufacturer provides some of the international equipment required. The owner will have to equip the yacht with devices required by national laws.

- In case of using the fixed fire-fighting system: do not ventilate the engine room, until the fire has been completely extinguished.
- Ventilate the engine room before entering. Ventilate the lower deck compartment before entering, if portable extinguishers have been used.
- When operating the gangway, be sure that nobody is in the way.
- Oils, used filters, emulsions, coolants and electrolytes are all harmful products: avoid contact with the skin and dispose of them carefully.
- In the engine room, be cautious with hot and moving parts.
- Wear hearing protection when entering the engine room.
- Do not use open flames and do not smoke, when handling fuel or lubricants.
- Do not scatter fuel in the environment.
- Replace the fresh water stored in the tanks frequently and apply bactericides as needed.
- Do not exceed speed limits in harbours or confined waters.
- Reduce speed in the proximity of other yachts or swimmers.
- Adjust speed according to sea conditions.
- Reduce speed before entering the engines room. Modify the course, if necessary.

- Before connecting to shore, make sure that the main switch on the switch panel is disconnected.
- Before leaving the yacht, turn the battery breakers off.
- Handle hot oils carefully, in order to prevent serious burns.
- Secure engines, shafts and generator prior to performing any maintenance activity.
- Open the coolant tanks very carefully, in order to prevent serious burns.
- Do not perform any work on the generator's electric board when it is running: serious risk of electric shock.
- Do not inhale exhaust fumes: risk of serious injuries or death.
- Before disconnecting a battery, check if the battery charger is operating. If it is, disconnect it and remove the negative wire first and then the positive one. When reconnecting the battery, follow the same steps in reverse order (the positive wire first and then the negative one).
- Replace any part showing signs of corrosion immediately.
- Never disconnect the batteries when the generator is running.
- Switch the radar off, prior to performing any work on the aerial.



DANGER

The responsibility for the operation of each yacht lies solely with the owner.

It is the Owner's direct responsibility to ensure, prior to departure, that the safety equipment required by law is present on board and fully functional.



DANGER

We recommend that you read the safety instructions in this manual carefully before you set off on your voyage and before operating the various on-board devices.

11.2 PRECAUTIONS FOR HARSH CLIMATES

Regularly check that all equipment and machinery containing water is protected with the correct proportion of non-toxic antifreeze.

If the outside temperature is below or close to 0°C, the fresh water and sea water systems run the risk of freezing.

Piping and hoses may break from freezing and this could lead to the yacht sinking.

Systems prone to freezing also include freshwater and saltwater cooling systems.

For more information on the maintenance and service requirements of your yacht and its equipment, and for special information about maintenance in cold weather, see the sections in this manual that refer to the single components, devices and equipment, but be sure to consult the User Manuals provided by the Manufacturers for specific information.

11.2.1 Cooling system

The antifreeze liquid is advised for all kinds of climates: it increases the working temperature range, lowering the freezing point and increasing the boiling point.

When the temperature comes close to 0°C it is necessary, in order to avoid the risk of freezing, to make sure that the cooling lines are filled with anti-freeze mixture. If not, replace the cooling liquid with such a mixture.

Before filling the system with antifreeze mix, it is necessary to wash the cooling circuit.

We recommend the use of antifreeze liquid.



ENVIRONMENT

Concentrated coolant must be treated as special waste.

When disposing of used coolant, abide by the regulations of the local authority.



CAUTION

Regularly check that all devices containing water are filled with the correct quantity of anti-freeze if necessary.

Each time that the outside temperature drops below 0°C the water (fresh or sea) inside the ducts may freeze and cause them to break.

All systems and equipment containing water, both sea water systems (engine cooling system, generator cooling system, etc..) and fresh water systems (windscreen wipers, fresh water pump, etc..) may run this risk.

11.2.2 Fuel system

With low temperatures, diesel fuel can form some solidified paraffin suspensions which can clog the fuel filters; making the normal engine supply impossible.

Fuel as per European standard EN590 guarantees fluidity up to 0°C during the summer period, and up to -20°C during the winter period.



WARNING

There is a special type of fuel for countries subject to very low temperatures.



CAUTION

Do not add petrol to fuel, in order to avoid serious engine damage.



CAUTION

Always refer to the manual provided by the Manufacturer.

11.3 NAVIGATION SET UP PROCEDURES

Accurate preliminary checks carried out with time, are fundamental for a safe navigation. Here is some fundamental advice to consider when setting up for navigation:

- Gather information on the weather forecast and warnings.
- Consult the pilot's book.
- Consult the navigation charts, and consider the cruise distance, courses, dangerous sea bottoms and flats.
- Consider the quantity of diesel oil necessary.
- Consider the length of navigation.
- Check the monitoring system and on the synoptic panel of the main helm station for warning lights for the bilge pumps, indicating the presence of water.

If the indicators are lit, turn on the bilge pump switches.

If pumps do not prime, batteries may be discharged (recharge batteries).

If pumps work, but water does not come out, this means that the suction are clogged (clean them).

- Check the cleanliness of the sea cock strainers for engine and generator cooling and for the other on board utilities. If they are dirty, check closing or close the hull valves, remove and clean the baskets, then replace them and close the strainer housings; clean and open the hull valves.

**WARNING**

During navigation, regularly check the cleanliness of the sea water strainer baskets. If the yacht is crossing a dirty sea area, check the condition of the strainers and proceed with their cleaning. Taking suitable precautions is very important to prevent damage to mechanical parts (engines, generator, etc..), discharge systems and not to jeopardize the safety of the yacht.

**WARNING**

Once the hull valves have been reopened, make sure that no leaks are present.

- Make sure that engines and generator V belts are properly adjusted. If necessary restore correct tension.
- Check oil levels of engines, gear boxes and generator. If necessary, top up.
- Check engines and generator coolant level. If necessary, top up.
- Ensure fuel system separator filters are properly clean. If water is present, drain the filters by mean of tap.
- Check the hydraulic oil levels of the various control units. If necessary, top up.

**WARNING**

To carry out the above mentioned checks and the top-ups, refer to specific manuals supplied by the Manufacturer.

- Check liquid levels (fuel, fresh water) in the tanks.
- Ensure everything necessary has been loaded (provisions, nautical charts, documents, rockets, first aid kit, etc..).
- Check the proper fastening of all mobile components, on the main deck and lower deck.
- Ensure the load has been distributed evenly, so that the yacht maintains a proper trim.

**CAUTION**

The materials stowed in the storage room can alter the trim, especially the transversal one. Try to arrange loads equally and securely, in order to avoid sudden displacements.

**WARNING**

The designated captain of the yacht must ensure that all persons on board are aware of the location of safety systems (fire extinguishers, life rafts, lifebuoys, etc.) and that they are aware of their use.

**CAUTION**

Safety equipment should always be checked before each navigation, in order to ensure the good condition of the safety devices and to become familiar with their location and use. The little time spent may be very useful in case of need.

- Create a checklist of safety equipment, as indicated herein after:
 - Ensure that life jackets are in good condition, that the inflating device is in working order and that the jackets are in the correct location and easily accessible (do not obstruct access hatches with anything).
 - Ensure that the life rafts are easily accessible and that their mooring and anti-capsize line is in good condition (properly rolled up and not worn out).
 - Ensure that the life belt is in its correct location and fitted with the relevant safety rope.
 - Check extinguisher charge level. The extinguisher is charged when the pressure gauge indicator is in the green sector.

11.3.1 Weather

Learn to understand weather patterns and signs of change.

Bad weather and sea conditions can cause an uncomfortable and unsafe situations.

Here are a few basic weather-related rules:

- Check the forecast and sea conditions before leaving and while navigating;
- A sudden change in wind direction or speed, or an increase in wave height indicates worsening weather conditions;
- If a storm approaches, immediately seek a safe harbour;
- If a storm hits, head the bow of your yacht into the wind;
- If you encounter fog, identify your position, set a safe course, slow down, and alert other yachts of your presence with a sound signal.

11.4 FIRST PERIOD OF USE

During the first period of yacht operation, in addition to the normal maintenance and check operations indicated in this manual, we recommend carrying out the following additional operations and more accurate checks.

The duration of this period varies according to the frequency and use modes, but are in any case suitable to allow a correct run-in of all systems and components on board.



WARNING

We recommend consulting the technical documentation provided by the Manufactures of the various on-board systems and components; they can indicate operations, checks and specific times not included in this section of the Manual.

Following the first period of use, the hereunder listed additional operations and checks, should be performed at longer time intervals, although in any case, they play an important role for the safeguarding and reliability of the yacht and navigation safety.

- It is recommended that new or overhauled engines should not be operated above 75% of their maximum load and at variable speeds. After this initial run-in, the engine should be brought up to full output gradually.
- After starting each engine, check for the correct circulation of the cooling water inside the circuit, by verifying that it comes out of the drains. Check also for the presence of leaks from the sea cock valves and strainers of the cooling circuits.
- Before the engines start, check the correct tension of the v-belts.
- Check the possible presence of unusual noises from the engines exhaust.
- Before and after navigation, check for possible leaks in the shaft lines.
- During navigation monitor constantly the temperatures and operation pressures of the devices on board (propulsion engines, generator, gear boxes).

- Check, by means of indicators installed on the main electrical panel, the correct charge condition of the batteries starting the engines and the utilities. Moreover, the engine alternators must correctly charge the batteries.
- Check rudder efficiency (by often checking the tiller angle) and the interceptor.
- Before and after navigation, check the correct oil level in the hydraulic systems.
- After the generator to start, wait several minutes before loading. Bring it slowly to maximum performance monitoring its correct operation.
- Check the correct load level of all extinguishers (fixed and portable) installed on board; the indicator needle on the pressure gauge should be set in the green range.
- Check the indicator of the main pressure gauge for possible pressure drops inside the system.
- Before and after navigation, check the correct operation of all bilge pumps on board.
- Check tightness and closure of portholes and hatches.



DANGER

Before performing the listed checks and maintenance operations, we recommend carefully reading the Safety Rules relevant to maintenance, contained in this Manual.



WARNING

Should more or less serious faults be noticed, contact the RIVA After Sales & Service Department as soon as possible.

**CAUTION**

RIVA declines all responsibility regarding tampering carried out by third parties on equipment installed in the Shipyard. Such tampering or unauthorized installations will not only immediately void the warranty, but may cause damage to the yacht and injuries to the people on board.

RIVA declines all responsibility concerning periodical maintenance activities scheduled by the Shipyard or by Manufacturers, but not carried out, on equipment/components, for which it is necessary to refer to their own Technical Manuals.

**WARNING**

Avoid prolonged use of engines at low speeds to avoid overheating of the exhaust pipes due to reduced cooling water circulation.

11.4.1 Engine drive

Despite the efficiency and the high performances of the yacht, and in particular the sensitivity to rudder motion, which allow an immediate response to the controls, the use of this yacht requires a careful and responsible behaviour.

In the passage between displacement and gliding navigation there is a critical phase to be carried out as quickly as possible, as it is characterized by high consumption and more vibrations; it also causes a very deep wake.

Minimum glide speed is influenced by displacement, weight distribution on board, position of trim tabs and sea conditions.

The excellent choice and quality of the engines allows keeping high speeds for a long time with no consequences.

However, an excellent compromise between travel speed, comfort and fuel consumption is achieved at speeds of around 1500/2000 rpm less than the maximum permitted rpm.

Do not keep the propulsion engines at idle run for a long period of time; this to prevent them from getting "dirty" or overheated.

Avoid harsh accelerations or decelerations to avoid excessive stresses for the engine turbines.

When the yacht reaches the cruising speed, the engine check instruments should set to constant values.

If the instruments show contrasting or abnormal indications during continuous run, check for failures of the systems or of the equipment and contact RIVA After Sales & Service Department.

**CAUTION**

Even if the automatic pilot controls the route, navigation must be supervised in any case.

**CAUTION**

During navigation, keep rear lateral sliding door closed to avoid the introduction of exhaust gases and water splashes into the main deck compartments, under special conditions of wind direction and force. This will improve comfort for the passengers and silence inside the compartments.

**CAUTION**

The speed of the yacht must be controlled, together with the position of the trim tabs, according to the sea conditions and the prevailing wave direction, so as not to subject the structure of the yacht to avoidable stress and assure the occupants' comfort when underway.

**DANGER**

It is absolutely forbidden to perform reverse run with one of the two engines stopped. This operation is allowed only in case of life danger for the persons on board and for the safety of the yacht itself, however when the engine is running it should not run higher than 1000 rpm.

11.5 REFUELLING

Refuel as follows:

- Ensure the yacht is properly moored, stop the engines and generator, if running.
- The fuel filler is located on the starboard and port sides of the yacht.
- Wash the teak with fresh water ahead of time to prevent soiling it accidentally.
- Loosen the filling nozzle, make sure that the refuelling pump is the correct size, then insert the pump and hold it still.
- Do not top up the tanks to the highest level, so as to allow the fuel to expand into the tank, without spilling out from vents.
- Tighten the filler cap firmly and remove any fuel drops from the hull and the teak.



CAUTION

The filler cap carries the indication "DIESEL" to avoid accidental introduction of different liquids.
Filling lines pressure must be kept constantly under 0.3bar during bunkering operations.



CAUTION

When refuelling open the fillers on both sides of the yacht.



CAUTION

Refuelling should be performed at the end of navigation, in order to allow fuel to cool down, without condensation. Drain the tank, every 2 or 3 refuelling operations. Before refuelling, wash the teak with fresh water to avoid its contamination with fuel.



DANGER

Do not smoke during refuelling, do not leave the yacht unattended, do not leave the engines running.



ENVIRONMENT

Do not disperse fuel in the environment: it causes pollution.



DANGER

Fuel leaks create a fire and explosion hazard.
Fuel cannot be stowed inside the garage.



CAUTION

Stop all engines when refuelling.

**DANGER**

It is forbidden to smoke, use naked flames or keep mobile phones switched on during refuelling.

**DANGER****Explosion/fire hazard**

- Stow flammable material in a safety-approved container. Never stow flammable material in non-vented areas.
- Check bilge and engine room for fumes.
- Keep the ventilation system free of obstructions.
- Never modify the ventilation system.
- Inspect the fuel system for leaks.

**DANGER****Explosion/fire/pollution hazard**

Fuel system connections that are too loose or too tight can leak, resulting in fuel spillage, environmental pollution and explosion/fire hazard.

11.6 WATER SUPPLY

Refill water as follows:

- Ensure the yacht is properly moored; we suggest stopping the engines and the generator, if running.
- The water inlet filler is located along the starboard side walk-around of the yacht.
- Loosen the filling nozzle and insert the hose (it must have suitable dimensions).

At the end of filling, remove the hose and tighten the filler cap.

**CAUTION**

Often replace fresh water in the tanks and, if necessary, disinfect it with suitable products. Avoid leaving the tanks full in case of frosting risk. Do not leave the yacht unattended while filling.

**CAUTION**

The filler cap is marked "WATER" to avoid accidental introduction of different liquids. To avoid damage to the system and tanks, we recommend replenishing by gravity and not by pressure.

**CAUTION**

Before refilling the fresh water tank, check that the water supplied by the shore fresh water system is potable.

11.7 SHORE CONNECTIONS

11.7.1 Water connections

To avoid using freshwater from the tank, it is possible to connect to an external water system using the intake located aft on the starboard side.

Connecting it supplies all the utilities on the yacht without having to use fresh water pump.



CAUTION

The pipe must be disconnected during periods when the yacht is un-manned.

11.7.2 Electric shore power supply

Proceed as follows to make the shore power connection:

- On the main engine room switchboard, open (OFF) the general magneto-thermal breakers of the on-board services;
- Open the switch protecting the shore power connector.
- On the dock power column, open the power switch;
- Connect the power cable, first to the yacht and then to the shore power column;
- Close the power switch on the dock power column;
- Close the power switch to protect the power supply to the yacht's shore socket;
- From the main electrical panel, select the shore power supply and monitor the voltage using the relevant instrument;
- Only if the voltage level is correct, close the magneto thermal breakers that feed the loads.

11.8 MOORING AND UNMOORING



CAUTION

Before the unmooring operation, ensure that engines, gear boxes, rudders and bow/stern thrusters are in good working order. During such manoeuvres, the Captain should prevent any unpleasant noise, and/or wake that might bother other people. Before unmooring, make sure that all doors, hatches, portholes, etc., are closed.



WARNING

Before starting the manoeuvre, make sure that people on board, especially children, do not obstruct operations and that they stay in suitable places.



DANGER

Check with extreme care that no one on board is in danger (with legs or arms outside the edge, in precarious balance or moving on wet or slippery surfaces) and that the fenders are well positioned and fastened.

The yacht is equipped with very powerful engines, with very efficient rudders and with high-performing bow/stern thrusters.

The bow/stern thrusters are to be used at very low speed, or without fresh way; at higher speed, it is possible to obtain a more correct reaction, by using the engines throttles in an off-set way.

The ability to exploit these excellent qualities depends mainly on the “familiarity” the Captain has with his yacht. Practice is the only way to acquire confidence, and finally you will be able to safely perform mooring and unmooring manoeuvres even in very difficult or crowded areas.

A basic rule, that should always be applied, is to manoeuvre at low speed, so as to have enough time to react and to better evaluate the situation; in this way, in case of accidental contact with other yachts, you will not cause any serious damage.

Before unmooring check following:

- That there are no other yachts manoeuvring nearby;
- That the mooring ropes are not damaged;
- That the fenders are positioned and well fastened (in case of wind or surf prepare a passenger with fender to avoid damages);
- That there are no floating objects or loose ropes which can damage the propeller.

If the yacht is moored with the stern to the shore:

- Undo the stern lines, haul in the chain until distant from the shore, and head to the exit.

If the mooring is on the side:

- Ease away the mooring rope from stern, warp on bow rope to move away the stern from the shore, manoeuvre for way out.

11.8.1 Leaving the mooring

The yacht is steered by means of the steering wheel that moves the rudders (rudder operation is independent from the engine operation).

In case of need and/or when in confined waters, manoeuvre the yacht by using the engines (changing the rpm and reversing the engine direction of rotation).

It is a good rule not to leave the steering wheel, particularly when cruising at high speed or in confined waters.

Do not exceed the speed limits when operating in confined waters, harbours and wherever required.

Keep in mind that the rudders effect is proportional to the propellers rpm and to the yacht fresh way, especially with headway; as a result of a high rpm and a high speed, the rudder efficiency is high, while when the engines are idling, with low fresh way, the reaction of the tiller angle is almost negligible.



WARNING

Before unmooring disconnect the electric cables for shore electric power supply.



CAUTION

It is the Owner's/the operators' responsibility to make sure that the mooring ropes, the towing ropes, the anchor chain, the anchor line and the anchor are suitable for the intended use of the yacht, i.e. the resistance of the ropes or chain must not exceed 80% of the resistance to breaking of the relevant strength point.

11.8.2 Mooring manoeuvre

Before setting back for the harbour, stop in free waters and test the gear boxes and the bow/stern thrusters. Also check:

- That mooring lines are ready for use;
- That the mooring point and the berthing course are free from incoming, leaving or moored boats or boats with the signal of unsteered craft at shore;
- Check that on the main electrical panel, all necessary uses are supplied (anchor winch, bow/stern thrusters, etc..). Disconnect unnecessary uses;
- That interceptors are lifted;
- That the yacht hook is easily accessible and does not hinder any passage;
- The operation of acoustic and visible signals and of swinging spotlight;
- In case of at-night mooring, have a torch light (possibly operating) handy;
- That the passengers will not interfere with operations and, if participating, they know whom to listen to and what to do;
- That bilge, grey water tanks and holding tanks are empty;
- That mooring ropes and fenders are correctly arranged.

Lift the interceptors, if necessary and reduce speed.

If the yacht is moored with the stern to the shore:

- Warp on stern ropes and on an anchor log, so as to haul the shore.

If the mooring is on the side:

- Warp on bow and stern ropes, so as to haul parallel to the shore.

Once moored:

- Stop the engines;
- Ensure that indication lights on the dashboard are off and disable engine start-up;
- Cut out any electrical equipment not in use and check the general condition of the main electrical panel and the indication of voltmeters and am-meters;
- Check bilge pump switches and their regular operation;
- Check bilge and dry it;
- Check for any leaks from shaft lines seals;
- Rinse the yacht with fresh water;
- Connect shore electric power supply;
- Stop the generator, once cooled down.

Before leaving the yacht, check following:

- Lower deck lights are not powered;
- Ensure that navigation lights and external lights are not powered;
- Ensure that unnecessary devices (plotter, radiotelephone, anchor winch, etc..) Are not powered;
- Ensure that devices in use are powered; (bilge pumps);
- Ensure that the shore plug is properly connected and the cable cannot be damaged;
- Disconnect battery breakers;
- Make sure that the devices (life jackets, yacht hook, torches, etc..) Are in their correct positions;
- Ensure that all bottles and containers with flammable liquids are properly sealed;
- Make sure that no food residues are left around (they could rot or clog scuppers etc..);
- Ensure that the gangway is in the right position and properly fastened;
- Ensure that mooring is correct (in case of bad weather conditions, tight-en the mooring lines as much as possible and check the distance from other boats is appropriate; ensure fenders are properly fastened, etc..);
- Ensure that sea water intakes are closed;
- That lower deck compartments are properly closed;
- That all portholes and the garage hatch are well closed;
- All fire extinguishers.

11.8.3 Unattended mooring

If the yacht is moored and left unguarded, operate as follows:

- Close sea cocks and overboard drain valves of sea water circuits.
- Check the condition of the main electrical panel and disconnect all unnecessary uses.
- Check all on board compartments, porthole, skylights and bilge.
- Ensure the yacht is safely moored.
- Disconnect all unnecessary uses.



CAUTION

The electric power supply from shore must be disconnected, especially if the yacht is left unattended for a long time.

It is necessary to recharge the batteries periodically.

Overboard outlets and drain pipes should be regularly checked, in order to ensure good buoyancy.

The electric system should be regularly checked, in order to prevent fires on board.



CAUTION

Inform the Port Authority about the location of the on-board fire-fighting system.



CAUTION

Disconnect the pump of the yacht.

11.9 OPERATION AND PRECAUTIONS DURING NAVIGATION

- During navigation do not unlock the chain stopper because you can seriously damage the yacht bow.
- Maintain a safe speed for the sea conditions, visibility, and when near other yachts.
- Do not exceed speed limits in harbour and confined waters.
- Follow all navigation rules applicable to the waters in which you are operating.
- Provide laminated plastic reference cards for the Rules of Navigation and have them available for quick reference at helm station.
- Consult charts for information on locations of reefs, rocks, shoals, or other hazards to make sure that the yacht is not at risk of grounding or collision with fixed or floating structures.
- Frequently check that your route ahead and around the yacht is unobstructed (no yachts or objects in the expected route or approaching your yacht).
- Frequently confirm the yacht's position as you cruise, using all available aids, such as charts, visual observations and bearings, depth soundings, GPS, radar, etc..
- If the yacht is controlled by the autopilot, be especially careful to keep a good visual watch. The autopilot cannot see.

- Before night navigation, make sure that navigation lights and search lights are operational. Ensure that the correct navigation lights are turned on for operation at night. Do not keep the anchor riding light on while the yacht is navigating.
- Use navigation lights in all conditions of reduced visibility, such as fog and rain and at all times between sunset and sunrise.



WARNING

When navigating at night, visual sharpness is crucial for a safe passage. To avoid collisions, reduce speed at night to compensate for limitations of visibility. Avoid switching on inner lights that may affect the captain's night vision.

- Know the characteristics of the sea bottom prior to anchoring. Keep well clear of other anchored yachts.
- During anchoring, pay special attention to avoid the rotating parts of the winch and take precautions when handling the anchor chain as it comes off the winch. Caution is needed to avoid injury to hands and fingers. Also, take care to avoid entangling feet and legs in the anchor rode.
- While the yacht is navigating, all persons on board must be seated in the designated seating areas in order to prevent injury due to falls caused by yacht movements with rough sea and in active wake areas or in the event of sudden changes in yacht speed or during manoeuvring. No one should be seated on the platform or forward decks when the yacht is navigating.

**WARNING**

For comfort and safety, reduce the speed in the presence of waves.

**WARNING**

Persons entering the engine room when the yacht is navigating should be aware of the hazards of the yacht's motion and their potential exposure to high ambient temperatures, hot equipment components and operating machinery within the engine room.

Prior to entering the engine room, set the yacht on the most comfortable heading for sea and wind conditions. Persons in the engine room should maintain communication with the captain.

**CAUTION**

To avoid heavy injuries or even death caused by hazards in the engine room, avoid the contact with hot and/or moving parts, while you are working in this area, wear proper safety clothing and also safety goggles and safety gloves. Be extremely cautious in proximity to hot and moving parts. Wear hearing protection if the engine is running.

**DANGER**

It is forbidden to carry out sudden manoeuvres at high speed. This can result in accidents to persons on board.

**DANGER**

It is forbidden to stand or sit on the forward cockpit while sailing at high speed.

**DANGER**

It is absolutely forbidden to perform reverse run with one of the two engines stopped. This operation is allowed only in case of endangering life for the persons on board and for the safety of the yacht itself, however when the engine is running it should not run higher than 1000 rpm.

**WARNING**

In order to achieve the best compromise between comfort and speed, while minimizing fuel consumption, it is recommended to keep the engine operating speed in the range between 1500 and 2000 rpm.

Observing the following guidelines will improve comfort, minimize noise inside the yacht, avoid damage and assist in the proper operation of the yacht.

- Do not run the engines at idle longer than necessary.
- Avoid sudden accelerations and decelerations, which create stress on engine turbochargers.
- Run at idle for a few minutes before shutting down the engines, to allow a gradual cool-down.
- Once the yacht is at cruising speed, the engine instrumentation readings should remain steady. However, if, during normal operating conditions, the engine gauges show abnormal or contradicting values, investigate for possible systems and/or equipment problems or failures (stop the engines).
- Monitor the control panel gauges and system condition alerts frequently.
- Once in open waters and well clear of other boats, increase the engine rpm gradually, until the desired speed is reached. Adjust the interceptor positions for the best performance.
- Adjust the speed to accommodate sea conditions.
- Check the engine exhausts. Very black smoke means in particular dirty filters or unburned fuel, due to improper calibration of injection pumps or injectors. Very white smoke may mean presence of water in the fuel. Bluish smoke may mean abnormal oil combustion.
- In case of abnormal vibration, reduce speed and run at slow rpm until the cause of the vibration is determined. If the vibration is severe, take the engines out of gear. It may be necessary to check the propeller condition. It may also be necessary to have a specialist check the propeller shaft alignment.
- Perform a visual inspection of the bilges periodically.

For the supply of fuel to consider the distance that we intend to cover.



WARNING

While the yacht is underway, all persons on board must be seated in the designated seating areas in order to prevent injury due to falls caused by sudden yacht movements in active wake areas or in the event of sudden changes in yacht speed or during manoeuvring. No one should be seated on the spoiler or forward deck when the yacht is navigating.



WARNING

Persons operating your yacht must never be under the influence of alcohol or drugs. The yacht's pilot should be experienced in the use of all instruments and controls, and know the handling characteristics of the yacht at all speeds and sea conditions. You should be certain that persons intending to operate your yacht are completely knowledgeable about its proper operation. If you are not certain about an individual's qualifications or competence, the person must be supervised by a qualified operator.

The yacht is very efficient and is equipped with very responsive rudders; nevertheless, because of its size and performance capability, only persons experienced, competent, responsible, cautious and with necessary qualifications should operate the yacht.

The yacht is manoeuvred by means of the steering wheel in the helm station. The steering wheel operates the rudders by means of an electric system. The steering gear operation is independent from the engine operation. Never leave the steering wheel unattended when the yacht is navigating.

Keep in mind that the rudder effect is proportional to the propeller rpm and the yacht's speed, especially when moving forward.

As a consequence, the rudder efficiency is high at high rpm and speed. On the contrary, when the engines are idling and the yacht's speed is low, the yacht's reaction to the tiller angle is almost negligible.

If necessary, or when in restricted waters, you can steer the yacht with the engines by varying and/or reversing the engine speeds and alternating power from port and starboard engines.

At low rpm, operating on a single engine, alternating port and starboard engines and using the "back and fill" method for turning the yacht is the recommended practice. Learn and practice the skills for handling the yacht at low speed and engine rpm.

When the yacht's speed increases, the transition of the hull from displacement mode to planing mode is a critical phase.

The transition to the planing mode should be done as quickly as practical to achieve fuel efficiency and provide a comfortable motion.

The minimum planing speed depends on yacht's displacement, on load distribution, on interceptor position and on sea conditions.

Adjust speed and interceptor position according to sea conditions and to the loading conditions of the yacht, in order to ensure an easy yacht movement and to avoid stress to the structure due to the effects of sea conditions.

**WARNING**

At high speed, the use of the autopilot is dangerous and not recommended. Anyway, be always very careful during navigation also when the autopilot is in use.

The high quality engines allow the yacht to be run safely at cruising speed for extended periods of time.

11.9.1 Operating in shallow water**COLLISION DANGER**

Use extra caution in shallow water or where underwater/floating objects may be present. Hitting an object at high speed or at an acute angle can seriously injure people and damage the yacht.

11.10 NAVIGATION IN SPECIAL CONDITIONS

11.10.1 Navigation with bad weather conditions

Your yacht has been designed for safe comfortable use, under all weather and sea conditions, bad or favourable; in any case, the navigation safety (especially with bad weather) depends mainly on the Captain's behaviour, who should either not set off or reduce the yacht's speed, sometimes considerably, and steer the yacht with the proper attitude.

It is very important during navigation in harsh weather, to make sure that all pieces of furniture, hatches, and mobile parts, are duly fastened or stowed, to avoid damages and above all to avoid hurting persons on board.

The reliability of the machinery, also due to a perfect maintenance, the scrupulous check during the pre-navigation phase and a Captain of proven experience assume, under adverse sea and weather conditions, an even greater importance. The following table shows the maximum speed allowed in function of the wave height, in order to safeguard the yacht structural integrity.

SPEED (KNOTS)	WAVE HEIGHT IN METRES
10	1,37
11	1,21
12	1,08
13	0,97
14	0,88
15	0,80
16	0,73
17	0,68
18	0,63
19	0,58
20	0,55
21	0,51
22	0,48
23	0,46
24	0,43
25	0,40
26	0,39
27	0,37
28	0,35
29	0,34
30	0,32
31	0,30
32	0,29
33	0,28
34	0,28
35	0,27
36	0,26
37	0,25
38	0,24

BEAUFORT SCALE	DESCRIPTIVE TERM	WIND SPEED		PROBABLE WAVE HEIGHT (METRES)	
		m/sec	knots	average	max
0	Calm	0 - 0,2	until 1	-	-
1	Light air	0,3 - 1,5	1 - 3	0,1	0,1
2	Light breeze	1,6 - 3,3	4 - 6	0,2	0,3
3	Gentle breeze	3,4 - 5,4	7 - 10	0,6	1,0
4	Moderate wind	5,5 - 7,9	11 - 16	1,0	1,5
5	Gentle wind	8,0 - 10,7	17 - 21	2,0	2,5
6	Fresh wind	10,8 - 13,8	22 - 27	3,0	4,0
7	Strong wind	13,9 - 17,1	28 - 33	4,0	5,5
8	Gale	17,2 - 20,7	34 - 40	5,5	7,5
9	Strong gale	20,8 - 24,4	41 - 47	7,0	10,0
10	Storm	24,5 - 28,4	48 - 55	9,0	12,5
11	Violent storm	28,5 - 32,6	56 - 63	11,5	16,0
12	Hurricane	over 32,7	over 64	14,0	

**WARNING**

RIVA declines all responsibility for the improper use of the yacht, in relation to the wave height conditions.

**WARNING**

Before undertaking navigation, it is necessary to be aware of the sea and weather conditions you will find along the transfer route and in the area you want to reach.

11.10.2 Navigation with one only engine

The yacht is driven by two powerful propulsion systems designed to operate together and at the same time.

In case of failure of one of the propulsion systems, you may navigate with only one engine.

In this case, we recommend that you:

- Shut off the failed propulsion engine;
- Set the position of the steering wheels in the opposite direction of the failed propulsion system; in case the steering wheels cannot contrast the asymmetric push of the operating system, lower the interceptor on the side of the failed system, or reduce the speed;
- Head to the nearest landing at a reduced speed;
- Keep the yacht at a speed that allows you the best manoeuvrability.

In case one engine stops due to a failure and the gear box is in idle position, during navigation keep a constant eye on the oil temperature of the gear box connected with the failed system.

The propeller shaft is kept rotating thanks to the water flow through the propeller; under these conditions some parts of the gear box are also kept rotating.

Should the temperature increases excessively over 80°C, lock the propeller shaft by engaging the gear box: in this way the resistance will be higher, because the gear box is jammed, but oil will not overheat.



WARNING

The yacht has been designed to navigate driven by two engines; please remember that it is possible to navigate with one engine only in case of emergency and for a very short time.



DANGER

It is absolutely forbidden to perform reverse run with one of the two engines stopped. This operation is allowed only in case of life danger for the persons on board and for the safety of the yacht itself; however when the engine is running it should not run higher than 1000 rpm.

11.11 ENGINE EMERGENCY SUCTION FROM THE BILGE

In the engine room there is the bilge emergency draining system, which operates with shunters, which allow using the sea water pumps, driven by the propulsion engines as draining pumps.

There are valves which, in normal position, ensure the sea water suction for engine cooling, through the sea cocks and the sea water strainers. In case of emergency, operate the handwheels of both valves, bringing them to the emergency position: the suction of the pumps, driven by the engines is then diverted directly to the bilge.

Should it be necessary to use this draining system, the bilge level must be checked continuously, because in case of complete drainage, the engines will be without coolant.



CAUTION

In case of emergency it is possible to suck the water from the bilge through the sea water pumps of each engine.

1. Engine sea cocks
2. Bilge emergency suction cocks
3. Suction selection handwheel
4. Engine sea cock strainers



CAUTION

When the bilge is empty, remember turning the valves back to sea water intake position, in order to avoid damaging the engines.

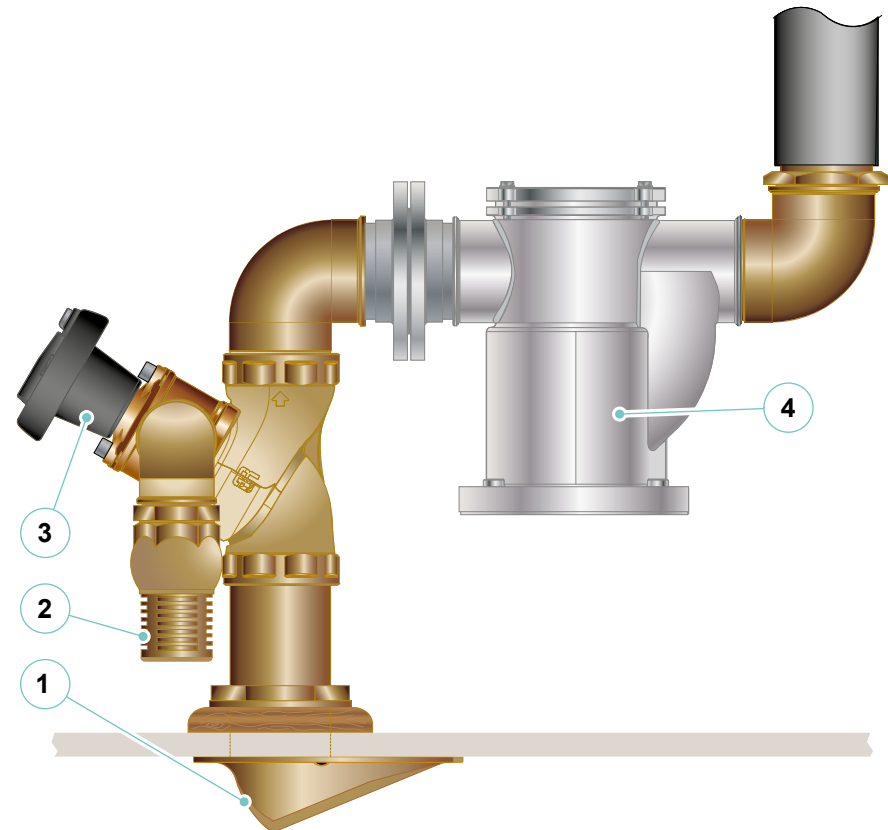

Operating diagram:

All valves are provided in the sea-open position. Before proceeding with the installation, visually check the passage and that the wording through the handwheel window reads: **APERTO MARE / SEA-OPEN**.

The direction of the water flow through the valve must align with the arrow on each valve.

The handwheel is provided with a position indicator to simplify its use.

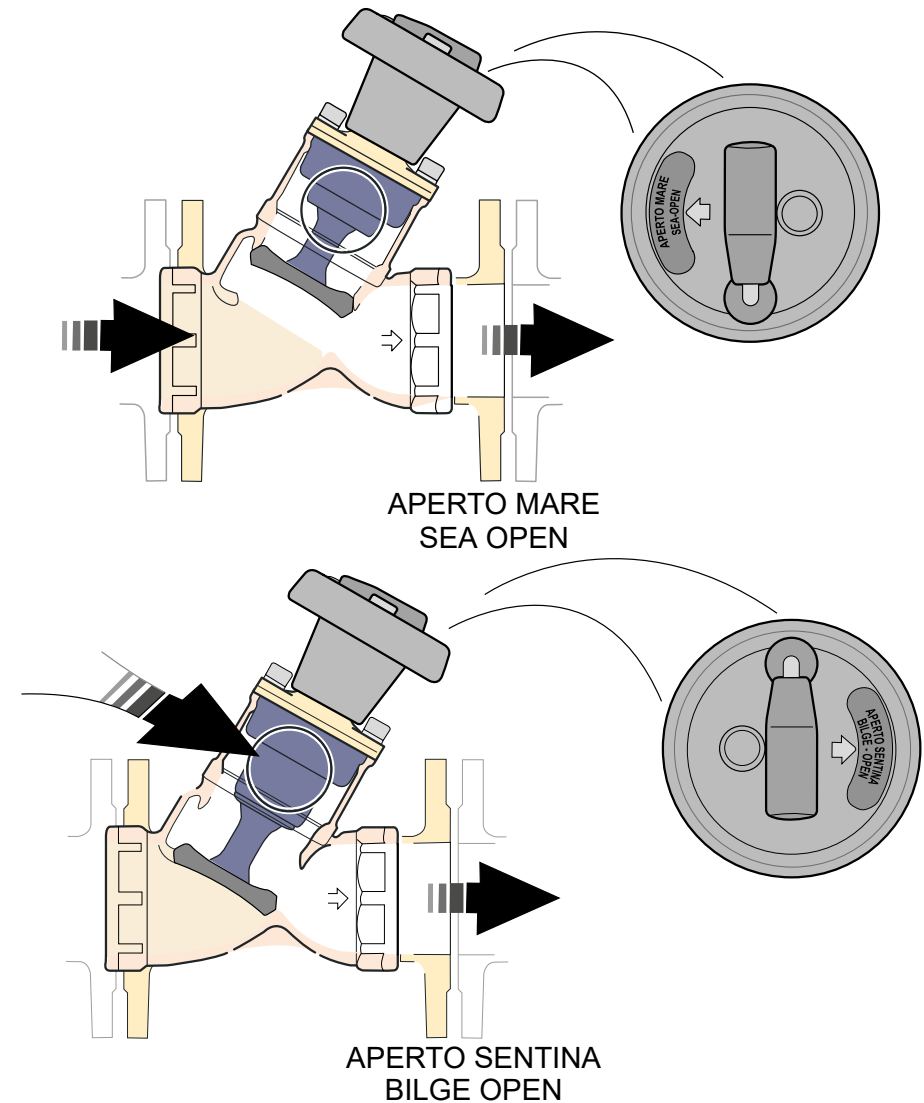

To enable water inlet from **SENTINA / BILGE**, proceed as follows:

Sollevare la leva del volantino
Lift the lever on the handwheel

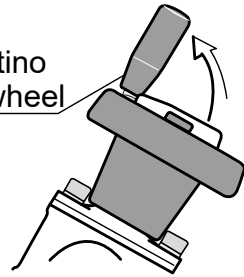

Svitare il perno sino al suo arresto
Loosen the pin until it stops

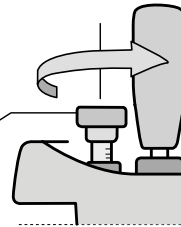

Tighten the pin until it stops

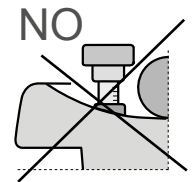
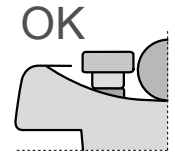
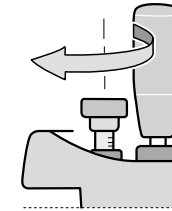

Turn the handwheel clockwise until it stops. In this phase the shutter, located in its housing, offers resistance. With both hands, close until it mechanically locks. The wording in the handwheel window will read: **APERTO SENTINA / BILGE-OPEN**, which indicates the inlet position.

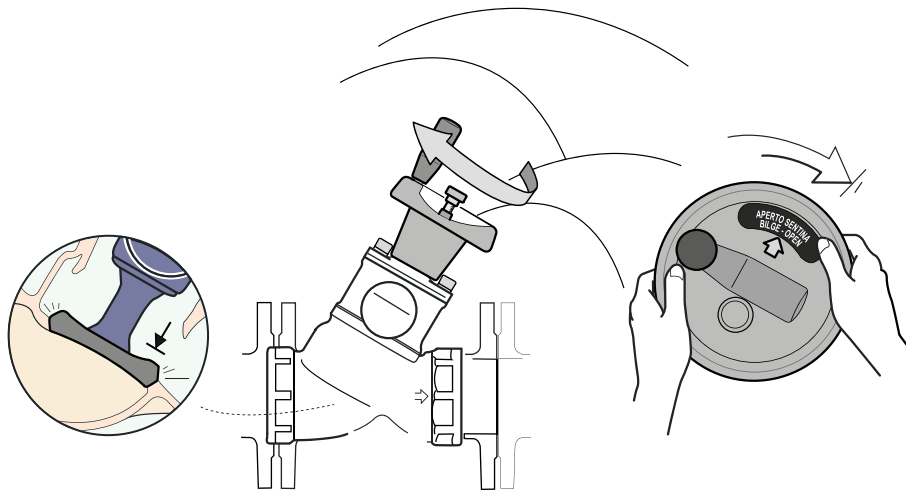

CAUTION

The pin is correctly tightened as shown.
A complete closure of the pin has the purpose of preventing any movement of the shutter.

Lower the handwheel lever into its seat.

To enable water inlet from **SEA**, proceed as described above, turning the handwheel counterclockwise. Once the operation is finished, the wording in the handwheel window will read:

APERTO MARE / SEA-OPEN

which indicates the inlet position.

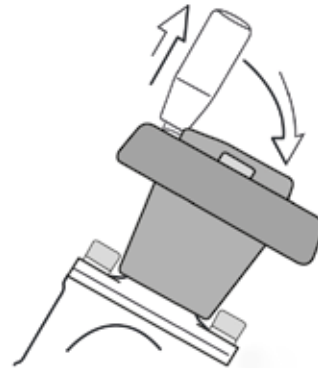

Maintenance:

During ordinary maintenance, which must be carried out while the yacht is in dry shore, it is recommended to extract the valve control block as follows: make sure that the indicator is positioned to **SEA-OPEN** (first turn the handwheel counterclockwise). Loosen the screws with an Allen wrench and extract the mechanism from its body, paying special attention to the rubber components (gaskets).

DO NOT remove the handwheel from its seat!

If necessary, clean the rubber components with fresh water and soap, do not use any chemical cleaners and pay attention not to damage the gaskets. If necessary, the control block can be replaced with a new one.

When reassembling, use silicone grease, and pay special attention to the seats of the gaskets.

Make sure to insert the mechanism in “**APERTO MARE - SEA OPEN**” position (first turn the handwheel counterclockwise as indicated in the INSTRUCTIONS).

Tighten the screws with a torque of approx. 9 Nm.

11.12 TOWING THE YACHT

In case the yacht needs to be drawn or towed, fasten the towing lines as shown in the figure, in order to distribute the load evenly and pull in the middle.

It is a good rule, after fastening the cleats, to carry on with the rope, and the winch: so as to load the strongest yacht's points only.

The towing rope length depends on the sea conditions, and must be adjusted in such a way to limit the pulling forces without damaging the deck fittings.



DANGER

Do not approach and do not carry out any kind of intervention on transmission during the towing because propeller can turn.



**WARNING**

In case it is necessary to tow another yacht, do this under calm sea and calm wind conditions only, and tow ship with a displacement not exceeding 50% of your ship displacement; in case of emergency, if towing is not possible, give help by taking on board people of the other ship, as many as permitted and possible, and reach the nearest harbour. Anyway, inform immediately the Port Authority.

**WARNING**

Towing navigation can be carried out continuously for 8 hours, provided that you constantly monitor the gear box oil temperature, which must not exceed 80°C.
If temperature exceeds 80°C, stop navigation and wait until the temperature lowers.
When the engine is shut OFF, the throttle position is unimportant.

**CAUTION**

Always draw other boats or let your yacht be towed at low speed. Never exceed the speed of the drawing yacht when you are being towed.

**CAUTION**

Fasten your yacht to a towing rope so that it can be released when loaded.

**CAUTION**

It is the Owner's/operators' responsibility to make sure that the mooring ropes, the towing ropes, the anchor chain, the anchor lines and the anchor are suitable for the intended use of the yacht, i.e., the resistance of the ropes or chain must not exceed 80% of the resistance to breaking of the relevant strength point.
The Owner should also determine which action is necessary when fastening a towing rope on board.

**CAUTION**

Do not stand near the ropes during drawing (or towing) operations, a rope that breaks can be extremely dangerous ("whip lash effect").

**DANGER**

During towing navigation, the propeller shaft has to be kept turning by the water flow through propeller. We recommend not carrying out any kind of service on the thrust devices (engines, gear boxes, shafts, etc..).

11.13 YACHT STEERING RULES

Ship in sight

We can consider three ways of encountering another yacht on the water:

- Encounter;
- Crossing;
- Overtaking.

Generally, the yacht with limited ability to manoeuvre has the right of course. We leave free the course and to pass it to stern. The yacht that has right of course is called privileged yacht. It can maintain its speed and course. The ship penalized is that must adjust their speed and/or course to maintain the due distance from the privileged ship.

Encounter

When you meet another yacht that goes in the direction parallel, both yachts must adjust their speed and course.

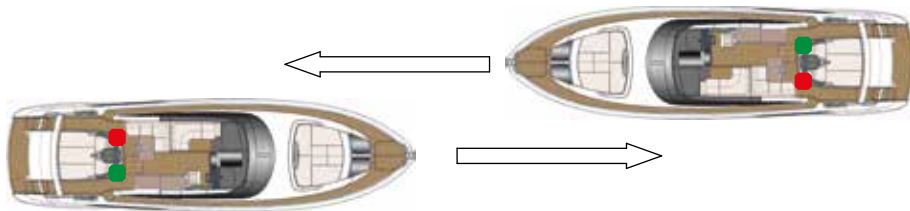

When two mechanical thrust yachts are meeting on intersecting or nearly intersecting courses such as to give rise to the risk of collision, each one must change its course to starboard so that each one passes on the left of the other.

Crossing

When two mechanical thrust yachts are crossing, creating a risk of collision, the one that has the other yacht at its starboard must move away and, if the circumstances so permit, avoid passing on the bow of the other yacht.

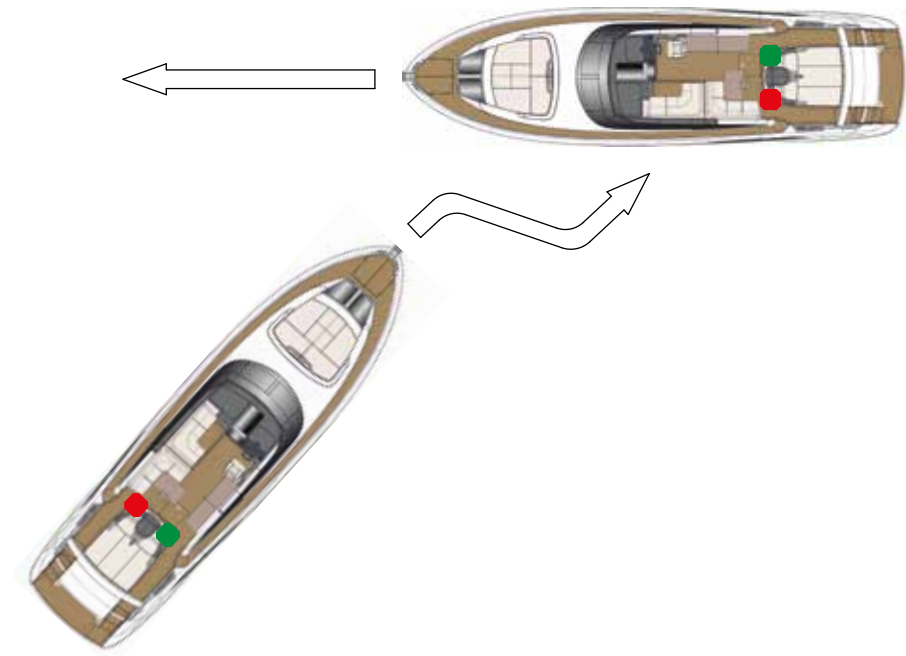
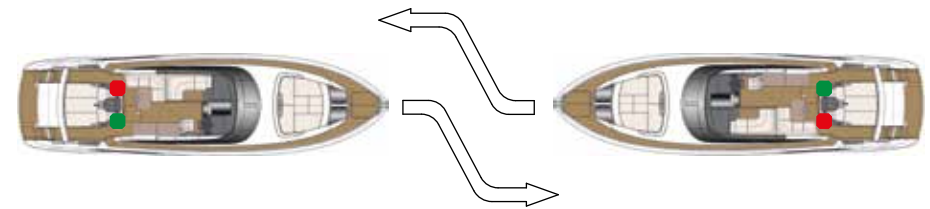

Overtaking

Overtaking is defined as when a ship coming from a direction of more than 22.5 degrees at stern compared to the yacht that it plans to overtake, such that it can only see the light of the yacht stern but neither of the two side lights.

If you find yourself having to pass a yacht proceeding more slowly than you and that is on your course, your yacht is the one penalized. Make all the necessary adjustments to avoid the collision and pass to the bow or starboard. Announce your intentions by sounding the horn twice if you intend to pass on the bow, and one time if you intend to pass at starboard. The yacht that is reached by another yacht takes precedence over the latter and therefore must maintain the same course and the same speed without laying or manoeuvring.

The yacht that has the bow within a 135° angle (formed by the yacht stern light) is considered the yacht that can be reached.

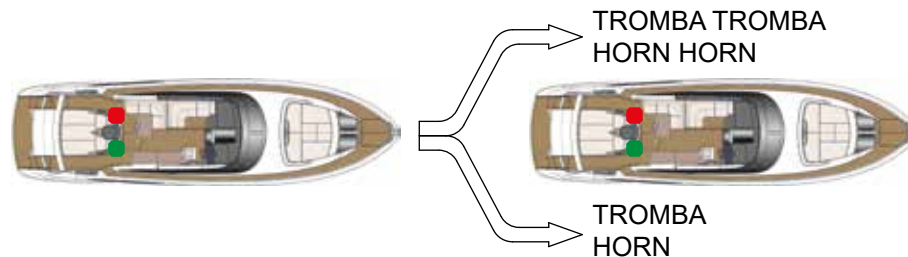

CAUTION

Having the right of course does not relieve you from the responsibility of avoiding a collision.



CAUTION

Yachts with limited ability to manoeuvre usually have the right of course. In the event of an imminent collision, prudence has priority over right of course.

11.14 ANCHORING OPERATIONS



CAUTION

If the anchor has to be used, unlock it, check the wildcats clutch engagement and test the operation of the anchor winch from the helm station in use.

We remind you that the anchor winch system has no end stroke safety controls, therefore we suggest you to handle “manually” the last chain metres, by means of remote controls and when this latter is close to the roller or when you reckon to lower almost the whole chain.

To avoid overheating of the anchor winch, it is advisable to help recovering it, by moving slowly the yacht toward the chain, without approaching it too closely, so as not to damage the hull.

If you weigh the chain after an anchoring on a muddy or weedy sea bottom, we suggest washing it during the weighing, using the button on the helm stations.

11.15 HAULAGE AND LAUNCH



CAUTION

The lifting method depends on the type of the lifting equipment; therefore it cannot be suggested.



CAUTION

Before the haulage and launching operations, check that no foreign materials are on board, that all items are properly rigged and that nobody is on board.



WARNING

Hauling and launching operations have to be carried out only by skilled personnel and in qualified shipyards and under their direct responsibility. RIVA declines all responsibility for damage to property and harm to persons caused by the wrong performance of the hereunder listed operations.

The lifting hoists must be in a good condition and particularly the lifting straps should not be worn out, and should be covered with suitable protections to preserve the bulwarks gel-coat and the antifouling paint on the bottom hull. The travel lift capacity must be greater than the yacht weight.

If only one crane is available, use a “spacer” to give the lifting straps an angle greater than hull width. Test the stability before lifting the yacht, its centre of gravity depends on the load and its displacement.



CAUTION

Never place the lifting straps in the areas highlighted on the drawing.

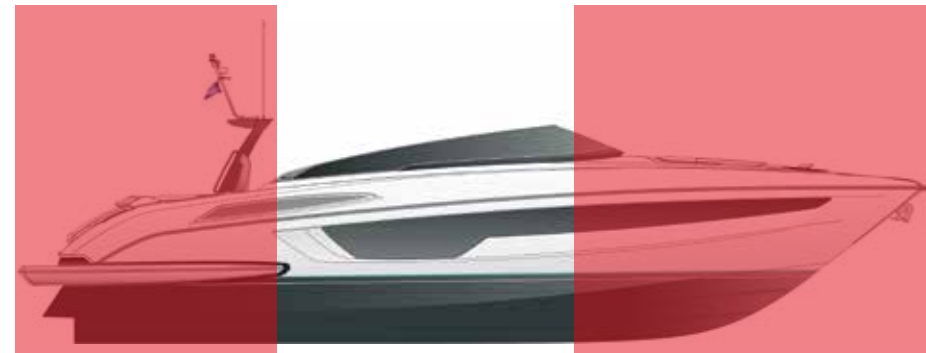

**CAUTION**

Do not put the lifting straps in way of intakes, of sea exhausts or of other protrusions.

Lifting straps must be positioned according to the loading conditions of the yacht at the moment of its lifting, because these vary remarkably, for instance, when the yacht is unloaded and dry or when the yacht is fully loaded. The lifting straps arrangement must be carefully evaluated each time, in order to prevent any damage to the yacht.

**CAUTION**

RIVA declines all responsibility for the location of the lifting straps, the lowering of the yacht to the ground and the support points carried out in other Shipyards.

**DANGER**

During haulage and launch, never stay underneath or in proximity of the yacht.

When ashore, the yacht must be located on a cradle with five supports of width and size adequate to distribute the yacht weight evenly.

The hull inclination must be as “natural” as possible, e.g. it must be parallel to the waterline and not to the keel. This to prevent that liquids on board keep a normal level and that rainwater can be drained naturally.

Cradles

RIVA is capable of providing the cradles for a correct support of the yacht (optional on demand). RIVA is not responsible for any damage resulting from the use of cradles different from those expressly produced by RIVA.

Propping

It is a common procedure to use supporting props if no actual storage capacities are available. It is very important to take some basic precautions while positioning the supporting props for the yacht in order to prevent damage to the hull structures, accidental falls of the yacht or injury to the involved personnel. The following list contains useful advice.

We also recommend always having propping operations carried out by experienced personnel.

- Use props with adequate strength and stability (each keel prop must support at least 1/5 of the whole weight of the yacht).
- Use correctly dimensioned supporting plates to prevent negative weight concentrations.
- Place the props preferably next to transversal structural reinforcements (stringers).
- Locate the props along the supporting fins of the hull.
- Always place at least 5 props along the keel, 3 props starboard and 3 props port in order to guarantee stability and weight distribution.
- Start positioning the three keel supports along a straight line, appropriately spaced to distribute weight.
- It is important that the props have the same height in order to prevent that the load is concentrated mainly on one of them.

- Have the yacht lowered very slowly until it almost touches the keel props, adjust the height of the props until they are in contact with the keel, in order to guarantee a uniform load distribution and a neutral trim of the yacht; keep part of the weight supported by the crane.
- Position the adequately spaced lateral props; it is important to remember that the lateral props must guarantee stability, but the whole weight must be supported mainly by the keel props.
- Check the support for stability, then completely lower the yacht and remove the belts.

The suggestions above are to be considered as being generally valid for propping the yacht without damaging it or harming the personnel involved; however, since the propping conditions may significantly vary depending on the props used and the surface on which the props rest, the above suggestions must be adapted case by case. RIVA is therefore not responsible for any damage to the yacht occurring while the yacht is at dry dock on props.

**CAUTION**

RIVA declines all responsibility for the location of the lifting straps, the lowering of the yacht to the ground and the support points carried out in other Shipyards.

Riva

56 RIVALE *supera*

HULL AND FURNITURE MAINTENANCE

CHAPTER 12

12.1 GENERAL MAINTENANCE OUTLINES

The yacht is equipped with a large number of sophisticated devices and systems, which require not only a certain care when it comes to use, but also regular maintenance to obtain correct operation.

One of the factors that might cause problems or faults, is usually the irregular use of the yacht and because of this, of the on-board devices.

Experience indicates that regular use of the devices normally gives fewer problems, and therefore, we recommend operating all on-board devices regularly, for short periods.

Daily checks and regular maintenance are important for maintaining equipment/components in the best working order and efficiency.

If the regular maintenance schedule is not correctly followed, the equipment's performance can deteriorate, causing reduced efficiency, a shorter life and the occurrence of unexpected problems which can compromise safety at sea.

The maintenance schedule is based on time intervals or running hours. For example, if a maintenance task is scheduled every 100 hours or 3 months, this task must be repeated at 200 hours or after 6 months, at 300 hours or after 9 months, and so on.

In case of a long period of inactivity (for example, during winter), it is advisable to lay up the yacht, possibly under cover.



CAUTION

Some general information about ordinary maintenance tasks, their schedule and procedures is provided herein with.

For further specific information referring to maintenance schedule, see Manufacturer Manuals of on board devices/components, issued by the various Manufacturers.



CAUTION

Look over the maintenance safety rules contained in this manual in order to act with the maximum safety and follow the indications here below.



CAUTION

During the replacements, remove the parts with care and order, in this way the assembly operations are as easy as possible.

Make sure to install genuine spare parts, in this way the system efficiency is not altered.

Sometimes the use of non-genuine spare parts may cause the withdrawal of the Manufacturer's warranty.

**CAUTION**

Check periodically that all equipment containing water is filled with the correct quantity of anti-freeze.

If the outside temperature drops below 0°C, all fresh or sea water systems are exposed to the risk of freezing and consequent breakage.

Systems especially subject to risks of freezing are all systems and devices containing either fresh or sea water.

**WARNING**

Before carrying out any maintenance and adjustment operation on the yacht, turn all necessary safety devices on and consider informing all personnel, in particular persons operating nearby. In particular, place warning signs in the areas concerned and prevent any device, if operated, from causing unexpected hazardous conditions, thus endangering the persons on board and/or property.

To avoid pollution, do not scatter any type of waste in the environment, and only use the dedicated disposal areas in the harbours.

**CAUTION**

When working in the engine room, switch magneto-thermal of the bilge draining pumps off, to prevent that fuel, lubricants and other liquid spilling causes sea pollution.

**CAUTION**

RIVA declines all responsibility for the installation and operation of electric, electronic or mechanical equipment improperly installed by third parties in a manner not authorised by the Shipyard.

RIVA declines all responsibility with regard to tampering carried out by third parties on equipment installed in the Shipyard. Such tampering or unauthorized installations will not only immediately void the warranty, it may also cause damage to the yacht and injuries to the people on board. RIVA declines all responsibility concerning regular maintenance operations scheduled by the Shipyard or by Manufacturers, but not carried out, on equipment/components, for which it is necessary to refer to the relevant Technical Manuals.

**CAUTION**

It is forbidden to use pressurized water on light appliances installed outside.

12.2 LONG PERIODS OF YACHT INACTIVITY

Following list only represents a general guide to give the customer an idea of the ordinary maintenances which should be carried out when the yacht remains stationary for a rather long period without being used. We recommend carefully checking the instruction manuals of the single devices, because they often contain detailed information and very important specifications relevant to the maintenance of each device.

The following instructions NEVER REPLACE the specific instructions concerning each single device and issued by the device's Manufacturer.

- **Engines**
Before winter time let fresh water flow into the sea water circuit, check the antifreeze liquid, the sacrificial anodes against the galvanic currents, remove salt build-ups and spray protective agents.
Carry out the scheduled maintenance of the propulsion engines, indicated in the Use and Maintenance section.
- **Generators**
Use the same procedure as for the engines.
- **Inverters**
Carry out the sheduled maintenance for gear boxes.
- **Batteries**
Check the liquid level and regularly charge the batteries, protect the terminals with Vaseline grease; the best solution would be to disconnect the batteries from the system and to charge them regularly with a separate battery charger, but this is not always possible on yachts.
- **Watermaker (optional)**
A proper procedure provided by the supplier in the instruction manual has to be followed when the watermaker is not used for a long time.
- **Washers and Dishwashers**
Carry out an empty washing cycle, carefully remove all detergent residues, and dry thoroughly. Clean the filters.
- **Sun-deck cushions**
Remove all sun-deck cushions and store them into a dry place.

- **Aluminium and steel**
Wash all metallic parts with fresh water and protect by rubbing with a rag soaked into Vaseline oil.
- **Wood and interior upholstery**
Cover the cushions of sofas with sheets and above all cover all windows with the relevant covering sheets, so that as little light as possible is projected inside, because the UV-rays fade the wood and tissue colours.
- **Teak wood deck**
Wash with water and neutral soap and treat with proper products. Sandpaper if strictly necessary.



CAUTION

DO NOT USE mechanical or forced water jet equipment (e.g. pressure washers, etc.) to wash the deck, as this force alters the wood and the caulking sealants (it detaches the microparticles) causing damage in some cases even radical (e.g. detachment of the staves).



CAUTION

DO NOT USE alkaline-based or acid-based detergents or aggressive detergents (soda, solvents, ammonia, etc..) to wash the deck; their aggressive degreasing action corrodes the wood (it eliminates its natural water repellency and whitens its natural colour), while the caulking sealant modifies its physical-chemical qualities, softening the surface, damaging the waterproofing, sealing and anchoring of the deck.

- **Sacrificial anodes**
Check their wear and if necessary, replace the hull, propellers shafts and interceptor anodes, etc.

- **LOG Transducer**
Pull out the propeller, clean it and apply the proper propeller plug.
- **Windscreen wiper**
Wash with fresh water and lubricate with Vaseline oil.
- **Anchor winch**
Check the oil level in the gear box where possible. Check the oil level, protect the electrical components with a suitable protective spray and lubricate with silicon grease clutches and wildcat.
- **Water tank**
Wash with disinfectant, drain the fresh water circuit, especially if frost is forecasted.
- **Fuel tank**
Cleaning by means of a decanter especially if there are traces of water in the fuel.
- **Grey water tank**
Pour sterilizing products into the washbasin, showers, and bidet wastes . Empty the tank and clean, ensuring the float is efficient.
- **Black water tank**
Pour a sanitary product containing Paraformaldehyde (available in camping equipment shops) into the WCs and rinse the tank with this mix a couple of times. Drain the tank completely.
- **Air conditioning**
Before winter:
 - Let water flow in the sea water system.
 After winter:
 - Check the anti-freeze mix in the fresh water circuit: top-up or replace it if necessary (perform replacement at least every two seasons);
 - Carry out the maintenance operations suggested by the Manufacturer.
- **Tender engine**
Wash with the fresh water contained in the cooling system of the engine. Carry out the maintenance as recommended by the supplier.
- **Bow and stern thruster**
Protect the electrical components with a proper spray and check the oil level.
- **Electro-hydraulic control units**
Protect with the proper sprays and check the oil level.
- **Fire extinguishers**
Check the loading condition and expiry date for regular inspections.
- **Safety equipment**
Check the expiry dates of the self-inflatable means, flares etc.
- **Refrigerators**
Cleanliness for all and protection for those outside in case the yacht remains outdoors.
- **Engine room**
As for the engine room, we suggest carrying out a general cleaning, by removing all traces of salt drifts on devices and protect all electric, mechanic and hydraulic devices, by spraying them with protective agents.
- Clean all cabins and inspect all dunnages on-board.
- Check all hatches seals and lubricate their contact with appropriate silicone lubricant.
- Clean fan coils with an air jet, sucking the dust from the back net.
- Inspect the outer hull and all components: propeller, anodes, supports, interceptors, fan coils, sea cocks, bow/stern thruster.
- Carry out laying up of the yacht in a sheltered and dry place. If the yacht is stationed outside, cover it with a waterproof sheet, in such a way that allows ventilation. Otherwise the formation of damaging moisture could be helped.
- Wash the yacht with fresh water.
- Check all systems and fastenings on the yacht: damages, wear, cracks are signs of unsuitable use. Repair the damaged equipment. If necessary, fit new ones.
- Check the efficiency of limber holes and that they are not clogged so as to cause the leaking of the bilge system.
- Check the fastening of the partial or total covering of the yacht.
- Disconnect all unnecessary utilities.

**DANGER**

During recharge the batteries produce explosive gas. Do not approach to recharging area with free flames or sparkles.

Avoid wrong connections; never connect a positive terminal (+) with a negative one (-).

12.3 RE-USE OF THE YACHT AFTER A LONG INACTIVITY

Engines

After the winter, check engines oil, gear boxes and replace them if necessary. Check oil and fuel filters and replace them if necessary.

- Adjust the belt tension of the alternator belts both of engines and generators.
- Fill the fuel tank. Vent the air of the fuel system.
- Start propulsion engines.



CAUTION

After a long period of yacht inactivity, carry out all above-listed operations and following checks:

- Check the condition of all hoses and connections of the steering system, interceptor, gangway, etc..
- Start the engines.
- Stop the engines.
- Clean fuel filters. Replace engine oil filters and add oil to the engines if necessary.
- Check all bilge pumps and their operation.
- Check the operation of the black water, grey water and sea water pumps.
- Check the operation of all on-board instruments used for navigation.

- Let the engine run at middle speed for some minutes, before letting them run at full speed.

Generator:

- Start the engine of the power generator.

Hull:

- Verify the hull.
- Have the bottom hull accurately cleaned, as well as the rudders and interceptors with brushes (with water) or a jet-cleaner (dry) to remove seaweed and scales.
- Check the paintwork condition of the hull. If necessary, have 2 coats of suitable antifouling paint applied by specialized personnel.



Propellers e anodes:

- Verify the propeller condition and possible leaks from the seals, if necessary adjust them.
- Check the conditions of the sacrificial anodes; if necessary, replace them.

Batteries:

- Check the charge of the batteries, and that their terminals and housings are dry and clean.

12.4 HULL MAINTENANCE

Component	Maintenance	Notes and precautions
Bottom hull	<p>Periodical cleaning and check of antifouling treatment (as required according to stationary area, but at least every three months)</p> <p>Check/restoration</p> <p>Preparation of the surface of an already treated yacht</p>	<p>The length of the anti-fouling effects depends mainly on the conditions of the waters where the yacht is stationed.</p> <div style="border: 2px solid yellow; padding: 10px; text-align: center;">  <p>CAUTION</p> <p>When removing the old antifouling, do not use sandblasting methods, as this may damage the gel-coat surface and the anti-osmosis resin applied by the Manufacturer. As suggested by the antifouling manufacturers, use paint removers or, as an alternative, wet sanding.</p> </div> <p>The Shipyard uses high-quality ant-fouling paint and applies two layers.</p> <div style="border: 2px solid yellow; padding: 10px; text-align: center;">  <p>CAUTION</p> <p>Bad maintenance condition may cause cavitation and damage shaft, rudders, propellers, etc..</p> </div> <div style="border: 2px solid yellow; padding: 10px; text-align: center;">  <p>CAUTION</p> <p>Small areas of paint may peel off from the propellers even after a short period of operation.</p> </div>
Hull	Washing of the yacht	<p>Wash at each re-entering from navigation.</p> <p>Only use neutral and biodegradable products in case of dirt stains.</p>
External coated parts	Cleaning	<p>Do not use abrasive or cutting means.</p> <p>Wash at each re-entering from navigation.</p>
Exposed metallic parts	Cleaning	<p>Wash with fresh water and dry with moistened (wash leather) cloth.</p> <p>When re-entering from navigation, wash with plenty of fresh water, especially the handrail base, the windows, the skylights, etc..</p>



CAUTION

Also in presence of rusty stains, NEVER work on the metal parts with brushes or abrasive cloths.
Such a treatment would scratch the surface, damage the polishing of metal parts and reduce their mechanical features.

NOTE

Keep all steps on board clean and dry.

12.4.1 Bottom hull

Antifouling treatment

If scales build up on the hull, this causes notable speed reduction and with time may damage the “gel-coat”. When you choose an antifouling paint for your yacht, it is important that you find the proper product, suitable for your yacht and for the waters in which you are going to navigate. Contact the RIVA After Sales & Service Department.

Check/restoration

The cleaning and checks have to be carried with yacht at dry shore or with the help of a diver. Have the repairs done only with yacht at dry shore.



WARNING

To clean or check the yacht in water, disable engines and generators ignition.



CAUTION

There are some hull areas (fastening area of thrusters shaft support base, submerged drainage areas, around the thruster tunnel and shaft exits, etc..) where operations can be carried out after hull pressing; in these areas, fillers are usually used which, over time, may produce local faults, like bubbles or small cracklings. These little faults do not impair the hull's mechanical strength at all. To repair them just sandpaper the area, remove the bubbles, and apply fillings suitable for the bottom hull.

- Have the bottom hull accurately cleaned, as well as the rudders and flaps with brushes (water) or a jet-cleaner (dry) to remove seaweed and scale.
- Check the paintwork situation of the bottom hull. If necessary, have 2 coats of suitable antifouling paint applied by specialised personnel.

Preparation of the surface of an already treated yacht

Carefully check the old anti-fouling paint to see if it is still good or if it needs a new layer. Make sure that the new product is compatible with the old one. Contact the RIVA After Sales & Service Department. If the old antifouling is crusty, thick and tends to scale off, then remove it and start the treatment as for a new yacht.



CAUTION

Antifouling is poisonous and should never be burnt, use only authorized disposal procedures and in case of doubts contact the authorities in charge. The sandblasting operations and removal of antifouling must be carried out with suitable clothes and protections.





WARNING



During the application of antifouling, make sure that following parts of the bottom hull are not painted:



- Depth sounder transducer;
- LOG speed sensor propeller;
- Sacrificial anodes;
- Shafts and propellers;
- Underwater lights;
- Hull porous plate.



Component	Maintenance	Notes and precautions
Wood and upholstery	Regular cleaning	<p>The worst enemies of these materials are light and moisture; to protect them, they must be kept away from direct light as much as possible and the interior must be ventilated as soon as the weather conditions allow. The use of external awnings is extremely important because there is no species of wood, either natural or dyed, which, when exposed to the sun's rays, does not undergo a change in colour.</p> <p>The woods used for the yacht's fittings are exclusively natural-based materials carefully selected and the painting cycles with which they are treated comply with environmental regulations. Furniture made of wood, precisely because of the natural origin of both the material and the treatments, may be subject, if not properly treated and maintained, to:</p> <ul style="list-style-type: none"> • Colour variations due to exposure to direct and continuous light. It is advisable to shade the heavily exposed parts with the internal curtains supplied with the yacht; • Retention of dirt if not cleaned promptly, given the characteristic absorbency of wood fibres. It is recommended to use non-aggressive products; • Scratches and marks if in contact with sharp or metallic objects, due to the inevitable relative "softness" of the wood. <p>Even if the production processes have been carefully studied and tested, the furnishings and fittings made of natural wood may undergo variations in colour over time due to the "natural" maturation of the material due to ageing.</p> <p>Despite the painting cycles developed after many years of experience, wood remains a "living" material, and therefore subject to movement and settlement. Scratches caused by bumps must be repaired immediately, to avoid the blackening of the wood below. The technical staff of the RIVA After Sales & Service Department will advise you about the maintenance level you have to apply at the end of each season's use. Correct maintenance will allow you to avoid deterioration which is expensive to repair.</p> <div style="border: 2px solid yellow; padding: 10px; margin-top: 20px;"> <p style="text-align: center;"> CAUTION</p> <p>The extremely precious finishes of the polish-varnished woods is the result of careful work: they are water resistant but at the same time delicate and need careful maintenance. Such surfaces must therefore be dried after use or after rain and must be washed and maintained regularly.</p> </div>



Component	Maintenance	Notes and precautions
Wood and upholstery	Regular cleaning	<div style="border: 2px solid yellow; padding: 10px; margin-bottom: 10px;">  CAUTION Upholstery and wooden parts: the leather and wooden parts have to be treated as natural products, subject to colour alteration, particularly if the necessary precautions for good maintenance are not taken. RIVA therefore reserves the right to evaluate any problems and its own responsibility according to case. </div> <div style="border: 1px solid black; padding: 10px; margin-bottom: 10px; text-align: center;"> MAINTENANCE At least once a week, carefully wash and clean all teak outside parts, and at least once a year perform a protective treatment with suitable products. </div> <div style="border: 2px solid yellow; padding: 10px;">  CAUTION Current use: <ul style="list-style-type: none"> • Do not walk or jump on the cushions; • Prevent the cushions from turning yellow due to direct exposure to sunlight; • Prevent the absorption of water or moisture by not leaving the upholstery exposed to bad weather, particularly during periods of inactivity. Cleaning: <ul style="list-style-type: none"> • Remove ordinary dirt with a warm water solution and neutral soap: do not use detergents or solvents; • Dry with a soft rag, not leaving any residues. Preservation: <ul style="list-style-type: none"> • Store clean and dry upholstery in a cool, ventilated room with no moisture; • Do not place heavy objects on upholstery when stored. </div>
	Cleaning	Dust with a soft and dry cloth. Clean with a soft, slightly moistened cloth.



Component	Maintenance	Notes and precautions
Teak	Regular cleaning	<p>The characteristic of teak is its resistance to weathering and therefore, it does not require maintenance. Over time, teak tends to assume a particular silver colour that may not appeal; in this case, to maintain the original colour of the teak, it needs to be treated regularly with specific products (e.g. teak wonder).</p> <p>If the wood has smears that cannot be removed with normal washing, it is necessary to sand the wood to remove stains, and then repaint with wonder teak.</p> <p>You must use fresh water and manual brush (no hard bristles) at least once a day. This will remove any machinery, common dirt from feet and shoes, and normal environmental salt. This process, if carried out regularly, allows constant maintenance of your teak and caulking. In this case only time and wear will naturally deteriorate this product.</p> <div style="border: 2px solid yellow; padding: 10px; text-align: center;">  <p>CAUTION</p> <p>Do not clean the teak with stiff brushes, as even rubbing the grain lengthways can damage the softer grain of the wood.</p> </div> <p>Non-black caulking may not behave in the same way as the black one.</p> <p>Any aesthetic issues, such as surface mildew, colour variations, dirt in the caulking are not defects and may be prevented with regular maintenance and service on the teak surface and caulking.</p>

Component	Maintenance	Notes and precautions
Teak	Regular cleaning	<div data-bbox="1420 284 1659 368" style="text-align: center;">  <p>CAUTION</p> </div> <p>Washing the deck with mechanical equipment or with a jet of pressurised water (hydro-cleaners, for example) IS STRONGLY ADVISED AGAINST since this force alters the wood and the caulking sealants (detaches the micro-particles), even causing serious damage in some cases.</p> <p>Washing the deck with alkaline or acid-based detergents, or however with aggressive agents (soda, solvents, ammonia, etc..) IS STRONGLY ADVISED AGAINST. Their aggressive degreasing action corrodes the wood (eliminates its natural water-repellent properties and bleaches its natural colour), while the physical-chemical properties of the caulking sealant are altered, with its surface portion becoming softened and the impermeability, sealing and anchorage of the deck becoming damaged.</p>
		<div data-bbox="1420 807 1659 892" style="text-align: center;">  <p>CAUTION</p> </div> <p>Be careful when cleaning the exterior painted parts. The use of alkaline or acid-based soaps or detergents, which are usually used to remove dirt or salt, can settle on the deck and irreparably damage the teak and caulking sealant.</p> <p>Therefore, teak and caulking sealant must be insulated when these washes are carried out. Therefore, when these washes are carried out, it is necessary to isolate the teak and caulking sealant from any deposits, even temporary, of soaps and/or detergents. If it is not possible to cover the deck when cleaning the fibreglass, we recommend wetting the deck surface with plenty of fresh water.</p> <p>We recommend the same procedure when refuelling.</p> <p>If fuel seeps into the wood or caulking sealant, the deck will be irreparably damaged there. Use a neutral detergent to clean the teak.</p>

Component	Maintenance	Notes and precautions
Ceilings Panels	Regularly check the flatness of the panels and / or any discontinuities or steps between the ceiling panels	<p>Whenever the ceilings are disassembled, it is compulsory to check the status of the Fit Lock or/ and 3M Dual Lock fastening systems, breakage of the teeth, and/ or the entire system.</p> <div data-bbox="880 363 2074 592" style="border: 2px solid orange; padding: 10px; text-align: center;">  <p>WARNING</p> <p>Do not install Fit Lock or 3M Dual Lock ceiling panels with damaged fastening systems , due to a possible reduction of their retention power. Damaged parts must absolutely be replaced with new ones.</p> </div> <p>In order to be sure that the ceilings have been reassembled correctly, check flatness with the other ceiling panels and the absence of discontinuities and steps between one ceiling panel and the others.</p>
Light alloys and stainless steel	Regular cleaning	<p>It is a good rule to accurately wash the entire yacht after each navigation, in particular all metal parts that may be damaged by sea water. Have plenty of fresh water sprayed on handrail, windows, skylights, rub rail, anchors, cleats and ladder. Protect all metal parts with Vaseline oil periodically.</p> <div data-bbox="880 927 2074 1011" style="border: 2px solid gray; padding: 10px; text-align: center;"> <p>MAINTENANCE</p> <p>At least once a year check the fastening of all metallic parts of the yacht.</p> </div> <div data-bbox="880 1059 2074 1248" style="border: 2px solid yellow; padding: 10px; text-align: center;">  <p>CAUTION</p> <p>Never use brushes or abrasive rags on metallic fittings, not even on rusty spots, scratches on the surface result in a less shiny appearance and diminish the mechanical features.</p> </div>



Component	Maintenance	Notes and precautions
Sun-deck cushions	Regular cleaning	<p>Remove the cushions from the seats at regular intervals and let their underside and the seat surface dry. When washing or when it is raining, remove the cushions and stow them in a covered place; however, when cushions are wet, remove them from their seats, to prevent water or moisture from remaining trapped between cushions and underneath surfaces. This could affect the gel-coat and also create osmosis bubbles and deteriorate the cushion cover. The cushions must be washed with running water; do not use jet-cleaners, brushes or abrasive sponges.</p> <div data-bbox="936 539 2139 662" style="border: 1px solid black; padding: 5px;"> <p style="text-align: center;">MAINTENANCE</p> <p>At least every 6 months, check seams and fasteners. At least every month carry out the washing of the cushions.</p> </div> <ul style="list-style-type: none"> • For light soiling, a solution of 10% PH neutral soap in warm water applied with a soft damp cloth. Rinse with clean water and dry. • For heavy soiling, dampen a soft white cloth with a one to one (1:1) solution of an all-purpose and dye-free household cleaner and water. Rub gently and rinse with a damp cloth. <div data-bbox="936 882 2139 1045" style="border: 2px solid yellow; padding: 10px;"> <p style="text-align: center;"> CAUTION</p> <p>Do not use alcohol-based cleaning agents!</p> </div> <div data-bbox="936 1090 2139 1281" style="border: 2px solid yellow; padding: 10px;"> <p style="text-align: center;"> CAUTION</p> <p>Do not use aggressive detergents and/or solvents, which will cause immediate damage and contribute to the deterioration of the material.</p> </div>

Component	Maintenance	Notes and precautions
Windscreen/windows	Regular cleaning	<div data-bbox="880 268 2078 496" style="border: 1px solid yellow; padding: 10px; margin-bottom: 10px;"> <p style="text-align: center;"> CAUTION</p> <p>Rags and chamois leathers used for cleaning glass must be replaced at least every 3 months. The inner side of windows and windscreen can be cleaned with non-aggressive and non- acid detergents for glass and a soft or paper cloth.</p> </div> <div data-bbox="880 539 2078 767" style="border: 1px solid yellow; padding: 10px; margin-bottom: 10px;"> <p style="text-align: center;"> CAUTION</p> <p>If, after normal cleaning, some traces of dirt or light scratches remain, do not try and remove them with mechanical means or using aggressive detergents, solvents or abrasive products. Contact the RIVA After Sales & Service Department.</p> </div> <div data-bbox="880 810 2078 1281" style="border: 1px solid yellow; padding: 10px;"> <p style="text-align: center;"> CAUTION</p> <p>For cleaning the outer side of coloured or mirrored (pyrolytic) windows and windscreen:</p> <ul style="list-style-type: none"> • Evenly wet the whole surface of the glass with plenty of fresh water. • Use a neutral detergent or a delicate commercial product (not alkaline) diluted in fresh water. • Spread the solution with a soft and clean cloth. Frequently rinse the cloth in order to prevent deposits of dust or dirt particles which could scratch the glass or its glazed coating. • Rinse the soapy surface with plenty of fresh (or distilled) water. • We recommend drying the glass with chamois leather only. <p>For cleaning the tinted windows and windscreen it is possible to use the same type of detergent used for internal cleaning (non-aggressive and non-acid).</p> </div>

Component	Maintenance	Notes and precautions
Mirrored glass walls	Regular cleaning	<div style="text-align: center;">  CAUTION </div> <p>For cleaning mirrored glass walls only use water and neutral soap. Different products could damage the surface coating.</p>
Windscreen wiper and washer	Regular cleaning (as required)	<p>Wash them carefully with fresh water and coat with Vaseline oil; grease the spring with silicone grease. Check the rubber blade conditions regularly, and replace the blades if worn; this prevents bad visibility problems.</p>
Windscreen and deckhouse glass	Inspection of seals	<div style="text-align: center;">  CAUTION </div> <p>At least once every 6 months check the condition of the glass seals. If you feel that the seals have deteriorated due to a wear, please contact RIVA After Sales & Service Department.</p>
Light fittings	Regular cleaning	DO NOT use alcohol-based products to clean the light bodies.

Component	Maintenance	Notes and precautions
Instrumentation and navigation lights	Regular cleaning (as required)	<p>Use clean wet rags for cleaning.</p> <div style="border: 1px solid black; padding: 5px; margin: 5px 0;"> <p style="text-align: center;">MAINTENANCE</p> <p>At least once a week, check the operation of the navigation lights. At least once a week, carry out careful cleaning of glasses and headlights. At least once every six months, check the presence of corrosion in the connections of the navigation light cables. At least once every six months, tighten the cable connections of the navigation lights.</p> </div> <div style="border: 2px solid yellow; padding: 10px; margin: 5px 0; text-align: center;">  <p>CAUTION</p> <p>Do not use chemical or abrasive products.</p> </div> <p>After navigation, cover instrumentation and equipment.</p>
Metal parts and connectors	Regular cleaning (as required)	Grease connectors and metal parts of the devices installed and exposed to moist and salty environment to prevent oxidation; pay particular attention to the components of the steering system, gangway, hatches, and control units, etc..

Component	Maintenance	Notes and precautions
Plexiglas	Regular cleaning (as required)	<p>To clean the Plexiglas, only use products that do not contain aggressive substances such as alcohol, ammonia or the like. Preference for antistatic liquid detergent.</p> <div style="border: 2px solid yellow; padding: 10px; text-align: center;">  <p>CAUTION</p> <p>Never use alcohol or acetone to clean Plexiglas parts; they could crack inside.</p> </div> <p>Use cloth of soft material (such as cotton or felt) To clean, degrease and polish the Plexiglas, spray a small amount of antistatic liquid detergent on the cloth and wipe the surface. The antistatic effect of the cleaner is very useful to prevent dust from being attracted by static electricity generated during rubbing and that makes it very difficult to clean the entire surface smoothly. If the cause of opacity is dirt, simply use an anti-static cleaning fluid and a soft cloth to remove smears: the Plexiglas will clean and bright. If opacity is due to the contact with aggressive substances, it means that the surface has been compromised in the structure and the Plexiglas will not return as before. If the marks are light and have been caused by wear and not from chemicals, anti-scratch paste can solve the problem. Even for light scratches anti-scratch paste is suitable.</p>

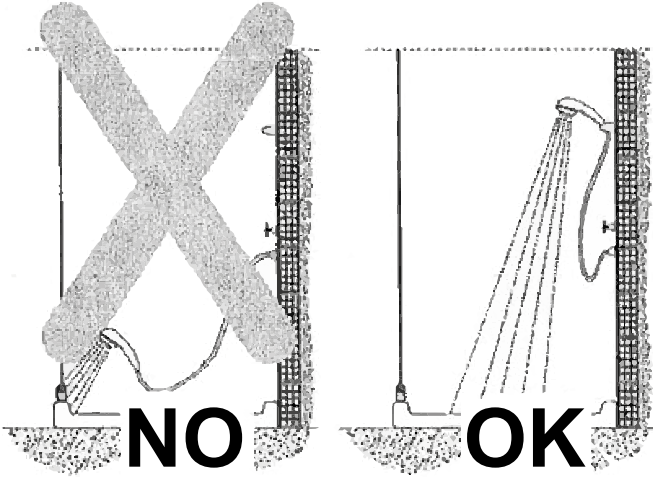
Component	Maintenance	Notes and precautions
Shower	Checking and replacing gaskets	<div style="border: 2px solid yellow; padding: 10px; margin-bottom: 10px;"> <p style="text-align: center;"> CAUTION</p> <p>Carry out regular maintenance and/or replacement of the shower box seals, in order to prevent water leakage.</p> </div> <div style="border: 2px solid yellow; padding: 10px;"> <p style="text-align: center;"> CAUTION</p> <p>The shower enclosures are made in such a way as to avoid water leaks outside the enclosure, under normal conditions of shower use. However, they do not have a watertight seal.</p> <div style="text-align: center; margin: 10px 0;">  </div> <p>The functionality of the shower cubicles is subject to the use for which it was designed; the water tightness is therefore conditioned by the correct use.</p> </div>
Fenders	Regular cleaning (as required)	Always keep all the fenders and their sleeves clean by washing regularly with fresh water, in order to prevent the salt deposited on them from scratching the paint of the hull.

12.6 MARBLE MAINTENANCE

THE WORST ENEMIES OF MARBLE ARE:

Some substances damage marble more than others.

Keeping them away from surfaces, or at least removing them promptly as soon as they come into contact with the marble is very important if you want to preserve its appearance.

The worst enemies of marble surfaces are:

1. **Water:** a enemy of marble, especially that with a high presence of limestone. If it settles on marble surfaces and is not dried, it can ruin them in the long run.
2. **Coffee, wine and dyes:** as dark substances, coffee, wine and other food dyes can damage marble when they come into contact with it.
3. **Tomato sauce:** tomato sauce, when it stains, is very difficult to remove, and the same applies to marble.
4. **Polishing wax:** marble should be polished from time to time, but never apply too much wax to avoid risking obtaining the opposite effect, i.e. making it dull.
5. **Sugary substances:** fruit, juices and sweet substances, if deposited on marble, can corrode it, ruining its natural lustre. If they accidentally fall on the marble, they need to be cleaned quickly.

HOW TO CLEAN MARBLE:

1. **Damp cloth:** If the stain to be removed is not particularly stubborn, a damp cloth can be used to clean marble surfaces and achieve an excellent effect.
It is important to always remember to dry the surface, otherwise, lime-scale will damage it.
2. **Marseille soap:** Marseille soap is also perfect for cleaning marble surfaces. Lightly dampen a cloth and rub it lightly on the soap, then wipe the marble. After rinsing, carefully dry the surface, which will look as good as new.

3. **Hydrogen peroxide:** Hydrogen peroxide is another product that can have infinite uses, including cleaning marble.
Put a drop of hydrogen peroxide on a damp cloth and rub it on the marble surface to quickly restore its shine.
4. **Baking soda:** Baking soda is another useful substance for cleaning marble.
Put a tablespoon of baking soda in a glass or container and mix. The resulting compound is a slightly abrasive paste that will penetrate the marble, freeing it from foreign substances, the stains.
Baking soda is also perfect for polishing, so the marble will look shinier after the treatment.
5. **Detergents for marble:** On the market, you can find numerous special detergents for cleaning marble surfaces.
They are very useful for those who have large marble surfaces to wash, such as floors.
Make sure that the detergent is not too acidic and aggressive, or the surface will be weakened over time and more susceptible to stains.

HOW NOT TO CLEAN MARBLE:



CAUTION

Do not use generic household cleaners of any kind.

Cleaning marble with products purchased in non-specialised shops that contain acids, alkalis and other chemicals can mark or damage the surface, leaving the stone more vulnerable to staining.

The most common and popular household cleaners are too aggressive for use on marble and can cause damage.

Trying to save time by using low-end products such as general surface cleaners will only lead to expensive repairs or marble restoration.

**CAUTION**

Do not use vinegar, ammonia or lemon juice.

Powders and even “soft” creams contain abrasives that can scratch and dull the surface.

Detergent soap scum and water are the main contributors to bathroom wear. Use only specific detergents for marble to avoid most marble cleaning problems.

**CAUTION**

Do not place toiletry products on the worktop.

Hair products, toothpaste, perfumes, colognes, nail products, creams, lotions and potions can stain or mark the surface leaving dots, rings or dull areas.

Protect surfaces by making sure these products do not come into contact with the marble.

12.7 MAINTENANCE AND CARE OF VARNISHED WOOD-EN PARTS

Wood is a natural material, and for this reason, its aesthetic characteristics may change over time and depending on climate conditions (surface shrinkage, changes in colour and dimensions, etc..). The natural origin of this material means that each product possesses unique features that enhance its handcrafted character.

Caring for the wood on your boat is an act of love and respect for your vessel. From old panels that tell stories to new surfaces ready for future adventures, looking after the wood is key to maintaining the timeless elegance of our RIVA yachts.

Below are some essential tips that RIVA considers fundamental for the correct maintenance of your yachts.

To preserve the beauty of our yachts, whether dealing with aged wood or brand new surfaces, it's essential to adopt a dedicated care regime.

The maintenance of these parts includes cleaning, inspecting for hidden damage, sanding, and applying protective varnishes or oils. Regular check-ups are important to keep the wood in excellent condition and extend its lifespan.

Let's go through the key steps for caring for wooden surfaces:

- **Regular cleaning of surfaces.**

Regular cleaning is essential to maintain the wood's appearance. Use gentle detergents, preferably those specifically made for marine surfaces, to remove dirt, dust, and salt deposits that can damage the wood over time. Do not use pressure washers or high-pressure tools. Always wash with fresh water only, using a soft brush or scrubbing brush. Brush across the grain to avoid scoring the surface, then dry with a soft, dry cloth.

- **Inspection of the condition of the varnish and repair of damaged areas.**

Carefully inspect the wood for any signs of damage such as cracks, scratches, grooves, or mould. If the surface is still in good condition, a simple clean and possibly a light touch-up with a clear protective varnish will suffice.

If, on the other hand, the varnish is damaged or deteriorated, follow these steps:

1. Sanding: Use fine sandpaper to remove damaged areas and even out the surface;
2. Cleaning: After sanding, remove dust with a damp cloth or compressed air;
3. Varnish application: Varnishing is one of the most important steps in wood care. Apply even coats of high-quality marine varnish. Consider using polyurethane-based products for better durability and resistance to the elements, or choose exterior-grade varnish (e.g., water-based enamels or specific synthetic varnishes);
4. Clear coat application: After applying coloured or protective varnish (except on decks with maple inlays), apply a layer of clear coat. This layer serves to protect the underlying varnish from external elements such as moisture, UV rays, and temperature fluctuations, helping to prevent damage or fading. It also adds a glossy or satin finish to enhance the appearance;
5. Drying and curing: Allow each layer of varnish and clear coat to dry fully, according to the manufacturer's recommended times. Proper curing is crucial for achieving optimal hardness and long-lasting protection.

- **Inspection of the condition of silicone seals and repair of damaged areas.**

Deterioration of silicone (sealants) used on wooden parts of the boat can compromise the integrity of joints and cause water ingress, potentially damaging the wood. Here are some signs that indicate a deterioration of the silicone surface or sealed joints:

- Visible cracks or fissures;
- Warping or shrinkage;
- Colour no longer shiny and uniform but faded or opaque;
- Loss of elasticity;
- Accumulation of mould or algae;
- Water infiltration near sealed areas;
- Roughness or dustiness.

If one or more of these signs is present, remove the old silicone and replace it with a new layer of sealant. Ensure the surface is thoroughly cleaned before reapplying to guarantee good adhesion and prevent future leaks.

Timely replacement of silicone is important for maintaining the boat's integrity and protecting the wood from moisture damage.

- **Protection and Precautions**

- Remove dirt, algae and salt with fresh water and a soft brush to prevent damage and deterioration;
- Regularly inspect wooden surfaces to identify and address any problems promptly, preventing more serious damage from occurring;
- Check that the silicone seals are uniform and that there are no cracks or degradation on the surface or in the joints;
- Avoid prolonged exposure to standing water;
- During the winter period or when the boat is not in use, use protective covers to reduce the exposure of the wood to the elements and temperature changes.

Summary table of operations:

Operation	Frequency	Description
Regular cleaning of the wood surface	At each use	Remove dirt, algae and salt with fresh water and a soft brush to prevent damage and deterioration.
Check for cracks or deformations	Quarterly	Regularly inspect the wood for cracks or deformations that could compromise the safety or durability of the wood.
Inspection of the varnish and finish	Quarterly	Check for damage or wear to the varnish and finish. Sand and reapply varnish as needed.
Checking the condition of the silicone seals	Every six months	Check that the silicone seals are uniform and that there are no cracks or degradation on the surface or in the joints.

Any restoration work on the boat must be carried out exclusively by authorised RIVA After Sales & Service Department using trained personnel.

Following the above recommendations is essential for maintaining the basic condition of the vessel and for upholding the boat's warranty.

12.8 SPEED MULTISENSOR MAINTENANCE

Component	Maintenance	Notes and precautions
Speed multisensor with valve	Regular check - Ordinary Maintenance	<p data-bbox="878 338 1429 368">As indicated in the Manufacturer's manual.</p> <div data-bbox="878 408 2078 561" style="border: 1px solid black; padding: 5px;"><p data-bbox="1368 419 1585 448" style="text-align: center;">MAINTENANCE</p><p data-bbox="891 456 1659 485">At least once every six months check the correct operation.</p><p data-bbox="891 491 1756 520">At least once every six months check the connection of the cables.</p><p data-bbox="891 526 1888 555">At least once every six months check the propeller and grease the outer Log.</p></div>

Riva

56 RIVALE super

TROUBLESHOOTING

CHAPTER 13

13.1 GENERAL NOTES

The yacht is equipped with a large number of complex devices and installations. These require regular checks and maintenance to keep their operation correct.

One of the factors that might lead to problems or faults, is usually the irregular use of the yacht and, as a consequence of this, of the on-board devices. Experience has shown that the regular use of the devices normally means fewer problems and, therefore, we recommend regularly operating all on-board devices for short periods.

When an on-board problem is detected, it is essential to carry out a quick check in order to understand its cause and, if possible, to find a remedy. In order to analyse a malfunction it is appropriate to ask the following questions:

- Is the malfunction caused by a human error?
- Is the malfunction due to bad weather conditions ?
- Is the malfunction due to a device failure or to a fault of another external device, but in some way connected to the first one?
- At what stage does the malfunction occur: at the start, at steady state, at device switch OFF?
- Does the malfunction occur repeatedly; if yes in which way?
- What does the malfunction imply from an operating point of view?
- Does the malfunction trigger any signals (luminous and/ or acoustic: sirens, buzzers, etc.) and/or messages on a display and/or anomalous noises (like whistles, beats, buzzes, etc..) and/or anomalous smells (burning smell)?
- Does the malfunction interfere with the operation of other devices?
- Is the malfunction a real apparent fault (that is, it can be cleared after a device reset and following switch ON).

The best, most complete answer we can give to the previous questions, will give us a malfunction analysis.

This section of the Manual analyses the most likely causes, that may lead to the malfunctioning of a component of the main components/devices on board. For any possible analysed cause, a corrective action is advised, in order provide a solution to the problem that is as effective as possible.



WARNING

We recommend, in order to operate with peace of mind, in full safety, taking good note of the Safety Rules relevant to Maintenance described in the "SAFETY RULES".



WARNING

Corrective actions may only be carried out by specialised and authorised personnel.

RIVA declines all responsibility for proposed corrective actions carried out by unskilled personnel.



CAUTION

For more detailed information, please refer to the various Manufacturer's Service Departments or contact the RIVA After Sales & Service Department directly.

13.2 PROPULSION ENGINES

For further information, please contact the RIVA After Sales & Service Department.

Problem	Cause	Corrective action
<p>1. Engine does not turn when starter is actuated</p> <ul style="list-style-type: none"> - Battery - Starter - Engine wiring - LOP Local Operation Panel - ECU Engine Control Unit - Engine - Start-interlock limit switch 	<ul style="list-style-type: none"> • Low or defective • Cable connections defective • Engine wiring or starter defective • Faulty • Loose seating of assemblies or connectors • Loose plug-in connections • Gear locked (engine cannot start manually) • Limit switch not installed or defective • Wiring defective 	<ul style="list-style-type: none"> • Charge or replace (see Manufacturer’s documentation) • Check that cable connections are properly secured (see Manufacturer’s documentation) • Check that cable connections are properly secured, contact Service • Contact Service Department • Visual inspection • Check plug-in connections • Contact Service Department • Check limit switch • Check wiring
<p>2. Engine turns but does not fire</p> <ul style="list-style-type: none"> - Starter - Engine wiring - Fuel system - ECU Engine Control Unit 	<ul style="list-style-type: none"> • Poor or defective starter rotation • Faulty • Not vented • Faulty 	<ul style="list-style-type: none"> • Charge or replace battery (see Manufacturer’s documentation) • Contact Service Department • Check vent • Contact Service Department

Problem	Cause	Corrective action
<p>3. Engine fires unevenly</p> <ul style="list-style-type: none"> - Fuel injection equipment - Engine wiring - Fuel system - ECU Engine Control Unit 	<ul style="list-style-type: none"> • Injector defective • Faulty • Not vented • Faulty 	<ul style="list-style-type: none"> • Replace • Contact Service Department • Check vent • Contact Service Department
<p>4. Engine does not reach full-load speed</p> <ul style="list-style-type: none"> - Fuel supply - Air supply - Fuel injection equipment - Engine wiring - Yacht - Rudder - Propeller 	<ul style="list-style-type: none"> • Shut off • Fuel pre-filter clogged (water/fuel separator) • Fuel filter clogged • Air cleaner clogged • Injector defective • Injection pump defective • Faulty • Yacht too heavy • Yacht's trim position • Marine growths on hull, propeller shaft, propeller, rudder • Rudder position • After propeller replacement: propeller too small/large 	<ul style="list-style-type: none"> • Open shut-off valve before fuel pre-filter (water/fuel separator) • Replace • Replace • Check air cleaner clogging indicator • Replace • Replace • Contact Service Department • Check yacht's load condition, reduce load if necessary • Trim yacht • Clean • Align rudder • Replace only with original spares

Problem	Cause	Corrective action
5. Engine speed not steady - Fuel injection equipment - Speed sensor - Fuel system - ECU Engine Control Unit	<ul style="list-style-type: none"> • Injector defective • Injection pump defective • Faulty • Not vented • Faulty 	<ul style="list-style-type: none"> • Replace • Replace • Contact Service Department • Vent • Contact Service Department
6. Charge-air temperature too high - Coolant - Intercooler - Engine room	<ul style="list-style-type: none"> • Incorrect coolant concentration • Contaminated • Air intake temperature too high 	<ul style="list-style-type: none"> • Check coolant properties • Contact Service Department • Check fans and ventilation air supply
7. Charge air pressure too low - Air supply - Intercooler - Turbo charger exhaust	<ul style="list-style-type: none"> • Air cleaner clogged • Contaminated • Faulty 	<ul style="list-style-type: none"> • Check air cleaner clogging indicator • Contact Service Department • Contact Service Department
8. Coolant leaks from intercooler - Intercooler	<ul style="list-style-type: none"> • Leaking, major coolant discharge 	<ul style="list-style-type: none"> • Contact Service Department
9. Exhaust gas black - Air supply - Fuel injection equipment - Yacht	<ul style="list-style-type: none"> • Air cleaner clogged • Injector defective • Injection pump defective • Overload 	<ul style="list-style-type: none"> • Check air cleaner clogging indicator • Replace • Replace • Contact Service Department

Problem	Cause	Corrective action
10. Exhaust gas blue - Engine oil - Exhaust turbocharger, piston rings, cylinder liner	<ul style="list-style-type: none"> • Too much oil in engine • Oil separator clogged • Faulty 	<ul style="list-style-type: none"> • Drain engine oil • Replace • Contact Service Department
11. White exhaust gas - Engine - Fuel system - Intercooler	<ul style="list-style-type: none"> • Not at operating temperature • Water in fuel • Leaking 	<ul style="list-style-type: none"> • Run engine to reach operating temperature • Check fuel pre-filter (water/fuel separator filter) and drain pre-filter • Contact Service Department

13.3 GEAR BOX

For further information, please contact the RIVA After Sales & Service Department

Problem	Cause	Corrective action
1. Transmission oil temperature too high	<ul style="list-style-type: none"> • Insufficient water flows through oil heat exchanger • Drain sludge from oil cooler • Undefined range, clutch slipping 	<ul style="list-style-type: none"> • Increase water flow • Clean oil cooler • Adjust mechanism
2. Transmission oil temperature too low	<ul style="list-style-type: none"> • Excessive water flow through heater exchanger 	<ul style="list-style-type: none"> • Reduce water flow
3. Oil pressure upstream of oil cooler and filter too high (*)	<ul style="list-style-type: none"> • Clogged oil filter • Oil cooler dirty 	<ul style="list-style-type: none"> • Clean filter and drain off oil sludge • Clean oil side of oil cooler
4. No operating oil pressure (*)	<ul style="list-style-type: none"> • No oil in transmission • Wrong rotation direction at transmission input • Faulty display unit 	<ul style="list-style-type: none"> • Add oil • Use special transmission version • Remedy fault
5. Operating oil pressure too low (*)	<ul style="list-style-type: none"> • Oil viscosity too low • Incorrect oil pump ratio • Defective oil pump • Pressure relief valve leaking • Timeswitch for pressure modulation defective 	<ul style="list-style-type: none"> • Use a prescribed oil grade • Adjust oil pump ratio to suit engine operating speed range • Replace oil pump • Remedy the fault • See Manufacturer's documents

(*) see monitoring data.

Problem	Cause	Corrective action
6. Operating oil pressure too high (*)	<ul style="list-style-type: none"> Oil viscosity too high Incorrect oil pump ratio 	<ul style="list-style-type: none"> Use a prescribed oil grade Adjust oil pump ratio to suit engine operating speed range.
7. Drive interrupted between transmission input and transmission output; clutch not transmitting torque	<ul style="list-style-type: none"> Mechanical transmission actuation: incorrect shift angle Electrical transmission actuation: electrical system fault Defective solenoid valve Longitudinal valve stuck No operating oil pressure 	<ul style="list-style-type: none"> Adjust setting Remedy electrical system fault Replace Remedy fault See "No operating oil pressure" or "Oil pressure too low"
8. Drive between transmission input and transmission output cannot be interrupted; clutch does not disengage	<ul style="list-style-type: none"> For possible causes and remedial actions, see "clutch not transmitting torque" fault 	<ul style="list-style-type: none"> Use a prescribed oil grade Adjust oil pump ratio to suit engine operating speed range
9. Clutch slips at high engine speed	<ul style="list-style-type: none"> Operating oil pressure too low (*) 	<ul style="list-style-type: none"> See remedy for "Operating oil pressure too low". If the fault cannot be remedied on board, proceed at reduced engine speed - so that the clutch does not slip - until repairs can be carried out. Avoid changes in direction or only change direction with the propeller almost at a standstill and with engine idle speed as low as possible
10. Oil level decreases rapidly (as indicated on the dipstick). See maintenance job "Oil level check"	<ul style="list-style-type: none"> Leaks on housing joints or oil lines, oil escaping from shaft seals Oil cooler leaking into cooling system 	<ul style="list-style-type: none"> Correct mechanical fault Remedy fault, replace oil cooler if necessary
11. Oil level increases. See maintenance job "Oil level check"	<ul style="list-style-type: none"> Water entering the oil circuit from the cooling system 	<ul style="list-style-type: none"> Correct mechanical fault

(*) see monitoring data.

Problem	Cause	Corrective action
12. Transmission is too loud at certain speed ranges	<ul style="list-style-type: none"> Torsional vibration resonance of propulsion system in engine idle speed range 	<ul style="list-style-type: none"> Avoid critical speed range. Use more suitable flexible coupling (see Manufacturer's document)
13. Transmission too loud at engine idle speed range	<ul style="list-style-type: none"> Torsional vibration resonance of propulsion system in engine idle speed range 	<ul style="list-style-type: none"> Increase engine idle speed range
14. Engine stalls following rapid change from "Ahead" to "Astern"	<ul style="list-style-type: none"> Engine idle speed too low Change in direction made too quickly or made at excessive craft speed 	<ul style="list-style-type: none"> Increase engine idle speed range Change direction (see Manufacturer's document)

If the fault cannot be remedied, the transmission lubricating oil supply is also at risk. Proceed at reduced engine speed only until repairs can be carried out.

13.4 GENERATOR

For further information, please contact the RIVA After Sales & Service Department.

Problem	Cause	Corrective action
1. Fluctuating or low oil pressure	<ul style="list-style-type: none"> Oil level too low Dirty oil 	<ul style="list-style-type: none"> Stop the generator immediately and top up with suitable oil Replace dirty oil with new suitable oil
2. Cooling water temperature too high	<ul style="list-style-type: none"> Excessive load Air in the cooling circuit Coolant low level or wrong mixture Sea water intake is obstructed or sea water intake strainer is clogged 	<ul style="list-style-type: none"> Reduce the load Bleed the circuit Restore the cooling water level and correct percentage Clean sea cock and strainer
3. Black smoke	<ul style="list-style-type: none"> Engine room insufficient ventilation Excessive load Unsuitable fuel Cooling water temperature too high Lack of maintenance 	<ul style="list-style-type: none"> Check that air intakes are not obstructed Reduce the load Replace with suitable fuel See step 2 Have the scheduled maintenance operations carried out

Problem	Cause	Corrective action
<p>4. Blue smoke</p>	<ul style="list-style-type: none"> • Excessive oil • Dirty oil • Lack of maintenance 	<ul style="list-style-type: none"> • Discharge the excess oil by draining oil filters • Replace dirty oil with new suitable oil • Have the scheduled maintenance operations carried out
<p>5. White smoke</p>	<ul style="list-style-type: none"> • Cold generator • Generator with too low load 	<ul style="list-style-type: none"> • Let the generator warm up • Increase the generator load
<p>6. Lack of power</p>	<ul style="list-style-type: none"> • Engine room insufficient ventilation • Fuel filter clogged • Unsuitable fuel • Cooling water temperature too high • Lack of maintenance 	<ul style="list-style-type: none"> • Check that air intakes are not obstructed • Clean • Replace with suitable fuel • See step 2 • Have the scheduled maintenance operations carried out
<p>7. Excessive or unusual noise</p>	<ul style="list-style-type: none"> • Insulation cover not properly fastened • Leakage from the exhaust • Exhaust not properly fastened • Lack of maintenance 	<ul style="list-style-type: none"> • Check • Check the exhaust • Check the exhaust • Have the scheduled maintenance operations carried out

13.5 BATTERY CHARGER

For further information, please contact the RIVA After Sales & Service Department.

Problem	Cause	Corrective action
1. Batteries not fully charged	<ul style="list-style-type: none"> • Charge current too low • Current to load too high • Charge time too short • Battery temperature too low • Defective battery (short circuit in cell) 	<ul style="list-style-type: none"> • See “charge current too low” • Decrease the battery load • Replace the battery • Use temperature sensor • Replace the battery
2. Battery loses charge quickly	<ul style="list-style-type: none"> • Battery capacity reduced because: <ul style="list-style-type: none"> - Wastage - Sulphating/stagnation 	<ul style="list-style-type: none"> • Replace batteries • Charge/discharge several times, this might help, otherwise replace batteries
3. Batteries are warm	<ul style="list-style-type: none"> • Defective batteries (short circuit in cell) • Battery temperature too high • Charge voltage too high 	<ul style="list-style-type: none"> • Replace batteries • Use temperature sensor • Check the switches setting
4. Batteries not fully charged	<ul style="list-style-type: none"> • Charge current too low • Current to load too high • Charge time too short • Battery temperature too low • Defective battery (short circuit in cell) 	<ul style="list-style-type: none"> • See “charge current too low” • Decrease the battery load • Replace the battery • Use temperature sensor • Replace the battery

Problem	Cause	Corrective action
5. Battery loses charge quickly	<ul style="list-style-type: none">Battery capacity reduced because:<ul style="list-style-type: none">- Wastage- Sulphating/stagnation	<ul style="list-style-type: none">Replace batteriesCharge/discharge several times, this might help, otherwise replace batteries
6. Batteries are warm	<ul style="list-style-type: none">Defective batteries (short circuit in cell)Battery temperature too highCharge voltage too high	<ul style="list-style-type: none">Replace batteriesUse temperature sensorCheck the switches setting

13.6 INVERTER (OPTIONAL)

For further information, please contact the RIVA After Sales & Service Department.

Problem	Cause	Corrective action
1. No output voltage and no lighting of warning lights (LED off)	<ul style="list-style-type: none"> • High output voltage • DC fuse burnt out • Switch set on remote control, but this is not available 	<ul style="list-style-type: none"> • Check the battery voltage and switch off the charger • Replace the fuse • Place the switch to ON
2. No voltage in output, LED of battery charge is ON	<ul style="list-style-type: none"> • Batteries flat 	<ul style="list-style-type: none"> • Charge the batteries, the inverter will switch on when the battery voltage exceeds 24 V
3. No voltage in output, temperature LED ON	<ul style="list-style-type: none"> • The inverter is overloaded 	<ul style="list-style-type: none"> • Reduce the charge and let the inverter cool down
4. No output voltage, LED "ON" is lit	<ul style="list-style-type: none"> • Inverter is in stand-by 	<ul style="list-style-type: none"> • Connect a charge or modify the jumper's settings
5. Low voltage in output	<ul style="list-style-type: none"> • Low power supply = jumper adjustment 	<ul style="list-style-type: none"> • Connect a charge > 30 W or modify the jumper's settings
6. The inverter turns on and off, the "ON" LED and the battery charger LED flash in turns	<ul style="list-style-type: none"> • Batteries flat • Wires are too thin • The connections are corroded or faulty 	<ul style="list-style-type: none"> • Disconnect the charge and charge the batteries • Replace with wires of correct diameter • Tighten connections. If wires are burnt out, replace them
7. The inverter lights ON/OFF, the ON LED is lit, the "overload" LED flashes once a second and the fan operates at full speed.	<ul style="list-style-type: none"> • The inverter is overloaded • The inverter has been switched off ten times as a result of an overload or short-circuit condition 	<ul style="list-style-type: none"> • Reduce the inverter load • Reduce the load or the short-circuit. Reset the inverter manually through ON/OFF switch

13.7 UTILITIES

For further information, please contact the RIVA After Sales & Service Department.

Problem	Cause	Corrective action
1. A connected utility will not receive power supply	<ul style="list-style-type: none">• Power line fuses blown• Wiring disconnected• Connections oxidised maintenance	<ul style="list-style-type: none">• Check the line and replace the fuses• Check wiring connections• Check and carry out proper maintenance

13.8 FUEL SYSTEM

For further information, please contact the RIVA After Sales & Service Department.

Problem	Cause	Corrective action
1. Irregular fuel supply to engines and generators and engines	<ul style="list-style-type: none">• Circuit valves closed or not fully open• Filters clogged	<ul style="list-style-type: none">• Check/Open• Clean

13.9 WASTE WATER DISCHARGE SYSTEM

For further information, please contact the RIVA After Sales & Service Department.

Problem	Cause	Corrective action
1. Holding tank or grey water tank drain irregular	<ul style="list-style-type: none">• Circuit valves closed or not fully open• Lack of maintenance• Abnormal pump operation	<ul style="list-style-type: none">• Check/open• Carry out maintenance• Check

13.10 FRESH WATER SYSTEM

For further information, please contact the RIVA After Sales & Service Department.

Problem	Cause	Corrective action
1. No water to outlets	<ul style="list-style-type: none"> • Circuit valves closed or not fully open • Tanks empty • Pump not receiving electric power supply • Protection pump mode 	<ul style="list-style-type: none"> • Check/open • Fill the tanks and bleed the circuit • Check • Reset
2. Pump starts even with outlets closed	<ul style="list-style-type: none"> • Circuit leaking 	<ul style="list-style-type: none"> • Eliminate leakage
3. The pump gets continuously on/off	<ul style="list-style-type: none"> • The tank has no air inside the membrane 	<ul style="list-style-type: none"> • Contact the Service Department

13.10.1 Watermaker (optional)

For further information, please contact the RIVA After Sales & Service Department.

Problem	Cause	Corrective action
<p>1. The pump runs but can't reach the pressure as indicated</p>	<ul style="list-style-type: none"> • The pump sucks air • Worn valves • Worn seat of pressure relief valve • Improper or worn nozzle • Worn gaskets 	<ul style="list-style-type: none"> • Check the intake pipes. They must be well air-tight • Check and/or replace • Check and clean • Check and/or replace • Check and/or replace
<p>2. Irregular pressure variations</p>	<ul style="list-style-type: none"> • Worn intake and/or pressure relief valve • Presence of foreign bodies in valves • Air suction • Worn gaskets • Relief valve too open 	<ul style="list-style-type: none"> • Check and/or replace • Check and clean • Check intake pipes • Check and/or replace • Close the valve nut clockwise
<p>3. Drop in pressure</p>	<ul style="list-style-type: none"> • Worn nozzle • Worn intake and/or pressure relief valve • Presence of foreign bodies in valves 	<ul style="list-style-type: none"> • Replace • Check and/or replace • Check and clean
<p>4. Noise</p>	<ul style="list-style-type: none"> • Air suction • Broken or unloaded spring of intake and/ or pressure valves • Presence of foreign matters • Worn bearings • Exceeding temperatures of pumped fluid 	<ul style="list-style-type: none"> • Check the suction pipes are well air-tight • Check and clean • Check and clean valves • Replace • Decrease the temperature

13.11 BILGE PUMPS

For further information, please contact the RIVA After Sales & Service Department.

Problem	Cause	Corrective action
<p>1. Bilge pump does not run. No water pumped</p>	<ul style="list-style-type: none"> • Wire connections • Blown fuse 	<ul style="list-style-type: none"> • Check wire connection integrity, make sure wire connections are not corroded • A visual check may not be enough, a slight pull on each wire will indicate if wires are still connected • Check to ensure that no wire joints are hanging down into the water • Check the correct fuse size (fuse size is printed on the side of the bilge pump) • If fuse size is correct, check the impeller through the inlet opening to be sure it is not jammed or stuck with debris
<p>2. Repeated blown fuse</p>	<ul style="list-style-type: none"> • Fuse rating or clogged impeller 	<ul style="list-style-type: none"> • Re-check fuse to verify compliance to pump specifications • Also examine impeller area & clean any obstructions
<p>3. Pump runs without water output</p>	<ul style="list-style-type: none"> • Airlocking/cavitating • Pump strainer & impeller area clogged with debris 	<ul style="list-style-type: none"> • Inspect & reposition hose for short vertical discharge • We suggest installing pump below water line to ensure sufficient water flow • Faulty or clogged check valve may add to pump air locking • Disconnect pump & clean outside of strainer, clean debris around impeller, & reattached & re-hook wiring

Problem	Cause	Corrective action
4. Pump shaft corroded	<ul style="list-style-type: none"> Electrolysis, cracked housing 	<ul style="list-style-type: none"> Inspect pump housing for cracks which can cause leakage into motor cavity causing corrosion Possible incorrect current running through wiring causing corrosion.
5. Pump stays on after water is pumped out	<ul style="list-style-type: none"> Wire connections may be incorrect, automatic pumps may have faulty circuit, possible electrical short 	<ul style="list-style-type: none"> On bilge pumps check for correct positive and negative battery connections
6. Nozzle breakage	<ul style="list-style-type: none"> Hose clamp fastened too tightly 	<ul style="list-style-type: none"> Suggest using plastic style hose clamp, do not use PVC hose
7. Pump impeller spins backward	<ul style="list-style-type: none"> Check wiring 	<ul style="list-style-type: none"> Switch wiring for correct polarity
8. Wires overheated, melted insulation	<ul style="list-style-type: none"> Incorrect fuse size, possible jammed impeller 	<ul style="list-style-type: none"> Inspect & clean impeller area of any debris Make sure that impeller is free to rotate Check to make certain correct fuse rating is installed REPLACE ALL DAMAGED WIRING

13.12 STEERING SYSTEM

For further information, please contact the RIVA After Sales & Service Department.

Problem	Cause	Corrective action
1. Air bubbles or foam in the system	<ul style="list-style-type: none"> The oil level in the tank is too low and does not allow the suction pipe to be completely plunged. In this way the pump sucks oil and air at the same time Possible openings and little holes on the suction pipes or faulty pump seals, which allow air to penetrate 	<ul style="list-style-type: none"> Check Check
2. The pump does not deliver oil	<ul style="list-style-type: none"> Wrong rotation direction Obstructed ducts or suction strainers Oil level in the tank too low Air leakages in the suction system Oil too viscous with some difficulties in passing through The shaft or other components of the pump are broken 	<ul style="list-style-type: none"> Check Check Check Check Check Replace
3. Lack of pressure in the system	<ul style="list-style-type: none"> The pump does not deliver oil Relief valve is not calibrated Free discharge of oil to the tank somewhere in the system 	<ul style="list-style-type: none"> Check Check Check

Problem	Cause	Corrective action
<p>4. The pressure of the system is low or fluctuating</p>	<ul style="list-style-type: none"> • Possible leaks in the piping or elsewhere in pressurized parts of the system • Relief valve set at a too low rate • The relief valve remains open or oscillates in its housing • Restriction of pump suction pipes or possible obstruction of filter • Air in leaks in suction pipes or by pump seals • Worn pump 	<ul style="list-style-type: none"> • Check • Check • Check • Check • Check • Check
<p>5. Pump too noisy</p>	<ul style="list-style-type: none"> • Wrong pump rotation direction • Oil with air bubbles • Oil viscosity causing obstructions to the suction system • Irregular flow of oil into the pump, caused by an insufficient filtering capacity of the filter (the filter could be dirty or not suitable) • Big lacks of charge along the suction line • Worn pump components • Relief valve vibrations • Mechanical vibrations due to bad anchor action 	<ul style="list-style-type: none"> • Check • Bleed • Check • Check/Clean • Check • Check/Replace • Check • Check

Problem	Cause	Corrective action
6. Too high temperature	<ul style="list-style-type: none"> • The pump is working at a higher pressure than permitted • Faulty or worn pump which causes internal leaks • Excessive blow-by through valves and cylinder • Oil too viscous • Continuous overloaded operation • Temperature too high in the room where the pump unit is placed 	<ul style="list-style-type: none"> • Check • Check • Check • Check • Check • Check
7. Leaks from the seals	<ul style="list-style-type: none"> • Possible abrasive substances have entered into the oil circulation, damaging the pump's shaft • Seals are faulty, broken or mounted in a wrong way • Too hot oil 	<ul style="list-style-type: none"> • Check • Check • Check
8. Pump overcharging the motor	<ul style="list-style-type: none"> • Too viscous oil • Obstructed delivery line or excessive resistance 	<ul style="list-style-type: none"> • Check • Check

13.13 AIR CONDITIONING SYSTEM

For further information, please contact the RIVA After Sales & Service Department.

Problem	Cause	Corrective action
1. High crankcase temperature	<ul style="list-style-type: none"> Overheating Poor circulation of treated water (winter cycle) or condensation water (summer cycle) 	<ul style="list-style-type: none"> Check coolant charge Correct circulation
2. Low suction pressure	<ul style="list-style-type: none"> Low coolant charge Poor circulation of condensation water (winter cycle) or treated water (summer cycle) 	<ul style="list-style-type: none"> Add Correct circulation
3. System noisy	<ul style="list-style-type: none"> Loose fastening bolts Unit base improperly insulated Improper support or insulation of piping Piping vibrations 	<ul style="list-style-type: none"> Tighten bolts Insulate foundation Use correct piping techniques and support piping with suitable hangers Clip pipes correctly. Check the couplings
4. Compressor does not start	<ul style="list-style-type: none"> Power off Thermostat broken Pressure switch open Faulty wiring Pumps not operating Flow-switch does not close Gas discharging unit 	<ul style="list-style-type: none"> Check the supply. Check fuses and/or magne-to-thermal Adjust thermostat Reset switch and check proper calibration, 20 bar (h.p.) and 2.5 bar (l.p.) Check diagram and rewire Check pumps free rotation. Check the magne-to-thermal Restore correct treated water circulation Check coolant circuit for possible breaks due to transport and installation

Problem	Cause	Corrective action
5. Compressor cycles intermittently	<ul style="list-style-type: none"> • Low pressure switch erratic in operation • Low coolant charge • Internal protection tripped 	<ul style="list-style-type: none"> • Check pressure switch setting. Check good circulation of condensed water • Add • Check for any voltage drop, correct
6. High delivery pressure with compressor stop (high pressure switch).	<ul style="list-style-type: none"> • Coolant overcharge • Insufficient or no condenser water flow; clogged condenser or sea-water strainer • Condensed water pump off • Poor treated water circulation (winter cycle) • Air in coolant circuit 	<ul style="list-style-type: none"> • Remove excess coolant • Adjust water regulating valve to condenser; clean condenser or sea-water strainer • Check pump and start • Check for air in the circuit. Check for possible clogging • Restore vacuum and refill with coolant

13.14 GANGWAY

For further information, please contact the RIVA After Sales & Service Department.

Problem	Cause	Corrective action
<p>1. The system does not react to the controls</p>	<ul style="list-style-type: none"> • Flat battery • 3 A fuse 	<ul style="list-style-type: none"> • Verify that the battery of the sender is loaded or correctly inserted • Verify that the self learning of the sender code has been carried out • Check that the hydraulic control unit is correctly supplied; check for the integrity of the 3 A fuse
<p>2. The gangway does not move smoothly</p>	<ul style="list-style-type: none"> • The hydraulic power unit has a thermal protection 	<ul style="list-style-type: none"> • Wait until hydraulic power unit is disconnected (about 5 minutes) and re-try handling on the adjusting trimmer (shift few degrees each time), if the problem continues, also with trimmer at bottom scale (clockwise) address to service department

13.15 BOW THRUSTER

For further information, please contact the RIVA After Sales & Service Department.

Problem	Cause	Corrective action
1. The electric motor does not turn and the warning light on the control panel is off	<ul style="list-style-type: none"> No electric power supply 	<ul style="list-style-type: none"> Check that the main magneto-thermal has been activated Check the status of the fuses of the control and main current; if necessary, replace them Possible presence of a short circuit; check the cables
2. The electric motor does not turn and the warning light on the control panel is on	<ul style="list-style-type: none"> Presence of a foreign body in the tunnel, which blocks the propeller 	<ul style="list-style-type: none"> Check and eliminate the cause of the block
3. The motor turns too slowly	<ul style="list-style-type: none"> The battery is insufficiently charged The contact of the carbon blades is poor Presence of seaweeds or fishing line stuck in the propeller 	<ul style="list-style-type: none"> Adequately charge the batteries Replace the blades Proceed to clean
4. The motor turns (too) quickly but there is no propulsion	<ul style="list-style-type: none"> The safety pin has broken due to the presence of an object in the tunnel 	<ul style="list-style-type: none"> Replace the safety pin and eliminate the cause of the block of the propeller
5. The thruster leaks oil inside the yacht	<ul style="list-style-type: none"> Damage to the circuit or to seals 	<ul style="list-style-type: none"> Check the hose and its connections and, if possible, repair the damage Check the sealing ring on the foot shaft and, if possible, repair the damage
6. The thruster leaks oil but not inside the yacht	<ul style="list-style-type: none"> Damage to the circuit or to seals 	<ul style="list-style-type: none"> Check the sealing rings of the thruster shaft, at foot base

Riva

A FERRETTIGROUP BRAND