

*Riva*

OWNER'S MANUAL

DOLCERIVA

This manual has been drafted in compliance with standard UNI EN ISO 10240.  
Any reprinting, either in whole or in part, without prior written approval by **FERRETTI S.p.A.** is strictly prohibited.  
This manual has been issued by **FERRETTI S.p.A.**



A FERRETTIGROUP BRAND

Registered offices:

Via Irma Bandiera, 62  
47841 - Cattolica (RN) - Italy  
Tel. +39 0541 839611  
Fax +39 0541 839625

Administrative headquarters:

Via Ansaldo, 7  
47122 - Forlì (FC) - Italy  
Tel. +39 0543 787511  
Fax +39 0543 473069  
[www.ferrettigroup.com](http://www.ferrettigroup.com)

[www.riva-yacht.com](http://www.riva-yacht.com)  
[customer.service@riva-yacht.com](mailto:customer.service@riva-yacht.com)

<b>1-</b>	<b>FOREWORD</b>	
1.1	SAFETY NOTICES .....	2
1.1.1	Specific safety warnings .....	3
1.2	USE OF TECHNICAL DOCUMENTATION .....	4
1.3	MANUAL INTRODUCTION.....	5
1.4	ORGANIZATION OF THE MANUAL.....	6
1.5	SERVICE REQUIREMENT METHOD .....	7
1.6	HOMOLOGATION CERTIFICATION AND IDENTIFICATION.....	8
1.6.1	Yacht identification data .....	8
1.6.2	Load-carrying capacity.....	8
<b>2-</b>	<b>GENERAL SAFETY RULES</b>	
2.1	GENERAL SAFETY RULES .....	12
2.1.1	Use-related rules.....	14
2.1.2	Maintenance rules.....	16
2.2	FIRE PREVENTION RULES.....	20
2.2.1	General fire prevention rules.....	22
2.3	DANGEROUS AREAS .....	23
2.3.1	Dangerous and forbidden areas .....	24
2.4	NOTES ON THE ENVIRONMENT.....	25
2.5	REGULATIONS FOR WASTE DISPOSAL.....	26
2.6	ESCAPE ROUTES.....	27
2.7	SAFETY EQUIPMENT.....	29
2.7.1	Safety plates .....	31
2.7.2	Emergency boarding system .....	32
2.8	USE OF THE SAFETY EQUIPMENT .....	33
2.8.1	Self-inflatable life raft .....	33
2.8.2	Portable fire extinguishers .....	36
2.8.3	Portable fire-extinguishers maintenance.....	38
2.8.4	Life buoy .....	39
2.8.5	Individual life jacket.....	40
2.8.6	Signalling rockets.....	41
2.9	FIRE-FIGHTING SYSTEM.....	42
2.9.1	Automatic engine room fire-fighting system.....	42
2.9.2	Manual fire-fighting system.....	46
2.9.3	Essential restoring for resuming navigation .....	48
2.9.4	CO <sub>2</sub> and high temperature sensors in the engine room.....	49
2.9.5	Maintenance of the fire-fighting system .....	50
2.10	MANDATORY SAFETY EQUIPMENT .....	52
2.10.1	First aid kit.....	53
2.11	ITEMS USEFUL TO HAVE ON BOARD.....	54
<b>3-</b>	<b>DESCRIPTION OF THE YACHT</b>	
3.1	MAIN DIMENSIONS AND CHARACTERISTIC DATA OF THE YACHT .	58
3.1.1	Main dimensions .....	58
3.1.2	Data and features .....	59
3.2	GENERAL DESCRIPTION.....	60
3.3	MAIN DECK .....	61
3.3.1	Main deck access .....	62
3.3.2	Navigation lights and shapes signals.....	70
3.3.3	Mast for visual day signals.....	72
3.4	LOWER DECK.....	74
3.4.1	Lower deck access .....	75
3.4.2	Galley.....	76
3.4.3	Owner's cabin .....	78
3.5	ENGINE ROOM .....	79
<b>4-</b>	<b>HELM POSITION</b>	
4.1	HELM POSITION .....	86
4.1.1	Top section.....	88
4.1.3	Bottom section .....	90
4.1.4	Starboard side section .....	91
4.1.5	Field of view from the helm position.....	92
4.2	NAVIGATION INSTRUMENTS.....	93
4.2.1	Radar / chartplotter / echosounder .....	93
4.2.2	Magnetic compass .....	94
4.3	SYNOPTIC PANEL .....	95
4.4	ENGINE AND THRUSTERS CONTROL JOYSTICK.....	96
4.5	THROTTLE .....	97

4.6	ENGINE STARTING PUSH-BUTTONS .....	98	5.2.9	Grey water system .....	166
4.7	VHF-RADIOTELEPHONE.....	99	5.2.10	Grey water system maintenance .....	169
<b>5- ON-BOARD SYSTEMS</b>			5.2.11	Black water system .....	170
5.1	ELECTRICAL SYSTEM .....	106	5.3	WC TOUCH PANEL .....	174
5.1.1	Fuse .....	111	5.3.1	Use.....	174
5.1.2	AC-DC distribution diagram .....	112	5.3.2	Setting of the courtesy light.....	174
5.1.3	Maintenance of the electric system.....	113	5.3.3	Black water system maintenance .....	176
5.1.4	Battery set.....	115	5.4	AIR CONDITIONING SYSTEM.....	178
5.1.5	Battery breaker panel.....	117	5.4.1	Air conditioning system maintenance .....	180
5.1.6	Maintenance of the batteries.....	119	5.4.2	Inspection and cleaning of the sea water intake strainer.....	181
5.1.7	Charge of the batteries .....	120	5.5	INTERCEPTORS SYSTEM .....	182
5.1.8	Battery check (accumulators) .....	121	5.5.1	Advice on interceptors operation .....	183
5.1.9	Battery charger .....	122	5.5.2	Interceptors system maintenance.....	184
5.1.10	Battery charger maintenance.....	124	5.6	THRUSTERS .....	185
5.1.11	Battery charger check .....	125	5.6.1	Use of the thrusters.....	186
5.1.12	Inverter.....	126	5.6.2	Thruster battery breakers.....	187
5.1.13	Inverter maintenance .....	128	5.7	GYROSCOPIC STABILIZER (OPTIONAL).....	188
5.1.14	Shore supply.....	129	5.8	SWIM LADDER.....	189
5.1.15	Socket use procedure .....	131	5.8.1	Swim ladder maintenance.....	191
5.1.16	Main electrical panel .....	132	5.9	GANGWAY .....	192
5.1.17	Engine room electrical panel.....	138	5.9.1	Gangway system maintenance.....	194
5.1.18	Generator set.....	144	5.10	STERN HATCH.....	195
5.1.19	Use of the generator .....	146	5.11	PROPULSION SYSTEM.....	196
5.1.20	Generator control panel .....	147	5.11.1	Propulsion engines .....	196
5.1.21	Inactivity periods .....	148	5.11.2	Engine Specifications.....	197
5.1.22	Generator maintenance .....	150	5.11.3	Propulsion engine maintenance.....	199
5.1.23	Inspection and cleaning of the sea water intake strainer.....	152	5.12	GEARBOX .....	203
5.2	WATER SYSTEMS .....	153	5.12.1	Maintenance of the gearbox .....	204
5.2.1	Bilge system.....	153	5.13	MECHANICAL SHAFT SEAL.....	205
5.2.2	Bilge system maintenance.....	156	5.14	STEERING SYSTEM.....	207
5.2.3	Bilge pump operation check.....	157	5.14.1	Steering system components.....	208
5.2.4	Fresh water system.....	158	5.14.2	Maintenance of the steering system .....	209
5.2.5	Cold water system .....	159	5.15	FUEL SYSTEM .....	210
5.2.6	Hot water system .....	161	5.15.1	Fuel circuit.....	212
5.2.7	Fresh water system maintenance.....	164	5.15.2	Fuel quality.....	214
5.2.8	Air bleeding .....	165			

5.15.3	Fuel system maintenance .....	215	6.7.1	Anchoring operations .....	254
5.15.4	Bleeding of separator filters .....	216	6.7.2	Anchor weighing .....	255
5.15.5	Separator filter cartridge replacement .....	216	6.7.3	Anchor lowering .....	255
5.15.6	Bleeding of filters .....	216	6.8	SUGGESTIONS FOR NAVIGATION UNDER SPECIAL CONDITIONS .....	257
5.16	SEAWATER COOLING SYSTEM .....	217	6.8.1	Navigation with bad weather conditions .....	257
5.17	ENGINES EXHAUST SYSTEM .....	221	6.8.2	Significant speed - wave height table .....	257
5.17.1	Maintenance of the engine exhausts .....	223	6.8.3	The wind rose .....	259
5.18	ENGINE ROOM VENTILATION SYSTEM .....	224	6.8.4	Wind classification .....	261
5.19	CATHODIC PROTECTION SYSTEM .....	228	6.8.5	Navigation with only one engine .....	264
5.19.1	Maintenance of sacrificial anodes .....	229	6.8.6	Collision .....	265
5.19.2	Replacement of anodes .....	229	6.8.7	Stranding .....	265
<b>6-</b>	<b>INFORMATION FOR USE</b>		6.9	ENGINE EMERGENCY SUCTION FROM THE BILGE .....	266
6.1	GENERAL INFORMATION .....	234	6.9.1	Operating diagram .....	267
6.2	PRECAUTIONS FOR HARSH CLIMATES .....	236	6.9.2	Maintenance .....	269
6.2.1	Cooling system .....	236	6.10	HAULAGE AND LAUNCH .....	270
6.2.2	Fuel system .....	237	6.11	DRAWING AND TOWING .....	273
6.3	PREPARING FOR NAVIGATION .....	238	6.12	GANGWAY .....	275
6.3.1	Preliminary checks .....	238	6.12.1	Manual operation of the oil control unit .....	277
6.3.2	Operation tests .....	239	6.12.2	Gangway system maintenance .....	280
6.3.3	Start of propulsion engines .....	240	6.13	SWIM LADDER .....	281
6.3.4	Check after engine start up .....	242	6.13.1	Inhibition sensor limit switch manual ladder and acoustic alarm .....	281
6.3.5	Engine drive .....	242	6.14	YACHT STEERING RULES .....	283
6.3.6	Stop of propulsion engines .....	243	6.15	MAINTENANCE .....	286
6.3.7	Emergency stop of propulsion engines .....	244	6.15.1	General notes .....	286
6.4	FIRST PERIOD OF USE .....	245	6.16	LONG YACHT INACTIVITY .....	288
6.5	REPLENISHMENT .....	247	6.16.1	General rules .....	290
6.5.1	Refuelling .....	247	6.17	RE-USE OF THE YACHT AFTER LONG INACTIVITY .....	291
6.5.2	Fresh water supply .....	249	6.18	HULL MAINTENANCE .....	292
6.6	MOORING AND UNMOORING .....	250	6.18.1	Hull .....	293
6.6.1	Mooring operations .....	250	6.19	GENERAL MAINTENANCE .....	294
6.6.2	Leaving the mooring .....	252	6.20	MAINTENANCE AND CARE OF VARNISHED WOODEN PARTS .....	309
6.6.3	Mooring operation .....	252	6.21	SPEED MULTISENSOR MAINTENANCE (LOG SENSOR) .....	312
6.6.4	Unattended mooring .....	253		<b>MANUAL ACCEPTANCE FORM .....</b>	<b>315</b>
6.7	ANCHORING .....	254			



*Riva*

DOLCERIVA

*Riva*

DOLCERIVA

1 - FOREWORD

## 1.1 SAFETY NOTICES

In order to highlight some important parts of the text and/or to indicate some important specifications, some symbols have been adopted, the meaning of which is described below.



### CAUTION

It indicates a reminder to apply certain safety measures or to avoid certain unsafe practices that could lead to personal injury or damage to the yacht, to its components or to the environment.



### WARNING

It indicates the existence of a possible hazard that may lead to personal injury or death, if proper safety precautions are not taken.



### DANGER

It indicates the existence of a serious hazard that could involve a high probability of death or of serious injury if suitable safety precautions are not taken.



### ENVIRONMENT

This symbol draws your attention to the possible hazards of environmental pollution.

### NOTE / MAINTENANCE

It indicates general notes or maintenance for the various on-board equipment.

### 1.1.1 Specific safety warnings

In addition to the general warning, they are intended to provide more direct information on the nature of any hazards.

#### Fire hazard

To indicate a specific fire hazard.



**DANGER**

The cause of fire breaking is described here.

#### Electric shock hazard

To indicate a specific electrocution risk.



**DANGER**

The cause of electrocution is described here.

#### Burn hazard

To indicate a specific burn hazard.



**DANGER**

The cause of burn is described here.

#### Forbidden areas

To forbid the access, the transit or the stay in a dangerous area.



**DANGER**

This area describes the forbidden area: for forbidden areas are meant dangerous places or the approaching to mechanical moving parts.

## 1.2 USE OF TECHNICAL DOCUMENTATION

The documentation provided by RIVA to the Owner consists of two types of documents:

- The owner's manual, produced in accordance with current regulations;
- The collection of technical documentation, related to on-board equipment and systems, consisting of a series of independent manuals, produced by the respective manufacturers.

The owner's manual constitutes the "guide" document and must be examined in its entirety and in any case before the manuals constituting the collection of technical documentation.

The associated Technical Documentation Collection makes up the set of the Reference Documents that are required to complete the information provided in the Owner's Manual.

Since these documents are independent and aimed at elaborating on single specific components, it is necessary to refer to them when referred to by the Main Document.

This manual has been drawn up by RIVA in their mother language (Italian) and translated into other languages, to satisfy the customer's requirements, and has been issued with the purpose of assisting you with the use of your yacht in full safety and with complete satisfaction.

We recommend that you carefully read through this manual so as to become familiar with its contents before starting to navigate for the first time.

### NOTE

The Technical Documentation Collection must be stored in a sheltered, dry place that is not subject to high temperatures and, ideally, near the Owner's Manual.

Moreover, take care of their condition, and of the Owner's Manual as well: do not fill the pages with writing or scribbles, do not remove pages, do not soak or expose them to flames or cigarette burns.

Even when you are looking at them, do not expose the pages to the risk of being stained or soaked by any liquid (water, beverages, acids, oils, etc..).



### CAUTION

RIVA suggests that you carefully review all the documentation provided by the various component manufacturers.

For any problems related to use or maintenance, please refer to the RIVA After Sales & Service Department listed in the manufacturers' documentation.

There are some interventions that, in case of emergency, can be carried out by the personnel on board, after having consulted the relevant manual.

### 1.3 MANUAL INTRODUCTION

A great passion for the sea and the prestige of this yacht, of its Owner, of his/her Guests and of the Crew are elements that encourage proper use and constant, regular maintenance to ensure long periods of navigation, a long life and a consequent improvement of safety.

This manual has been issued in compliance with the Directive 2013/53/EU, with UNI EN ISO 10240 rules and with RINA S.p.A. (REGISTRO ITALIANO NAVALE) requirements. (REGISTRO ITALIANO NAVALE).

The manual contains detailed explanations about the yacht, the systems and the equipment fitted, as well as information about the practical use of the yacht and its maintenance, and it is aimed at helping you achieve a safe and pleasant use of the yacht.

Moreover, the purpose of this Manual is to provide specific details and indications to personnel skilled in the operation of similar yachts and holding the required qualifications, acquired through examinations, specialization courses and experience acquired during previous on-board duties.

If this is your first yacht, or if this is a type of yacht that you are not familiar with, for your safety and to ensure your maximum satisfaction, make sure you have acquired sufficient experience about how to use and operate the yacht, before “taking the command”.



#### CAUTION

The captain shall be held responsible for any persons, objects and/or events on board.

#### NOTE

The maintenance operations described in the manual are simple, but should be performed by authorised and qualified technical staff only, according to the standard procedures delivered by the devices Manufacturers and in compliance with national and international regulations. We suggest contacting the RIVA After Sales & Service Department.



#### DANGER

This yacht may be operated only and exclusively by personnel qualified to operate and conduct the yacht in relation to the class of the yacht.

#### NOTE

This Manual shall always follow the yacht at each change of ownership. When you sell the yacht, it shall have to be delivered intact to the new Owner.  
SANCTIONS ARE PROVIDED IF THE YACHT IS NOT EQUIPPED WITH THE “OWNER’S MANUAL”.

**NOTE**

Although the manual has been specifically issued for your yacht, it is possible that some pictures of details in the manual do not fully match your yacht or that they do not reproduce the same colours of your arrangements.

This is due to the difficulty of taking pictures of details, such as bed covers and sofas, which are defined immediately before delivery of the yacht and, therefore, after the Owner's Manual has been written up.

**NOTE**

Under no circumstances shall RIVA be held responsible towards third parties for damage or for imperfect correspondence of the manual with reality.

**NOTE**

Please remember to store this manual carefully in a safe, dry and easily accessible place so that it can be easily consulted.  
If the manual is lost or worn out, RIVA shall always be able to provide you with a copy.

**1.4 ORGANIZATION OF THE MANUAL**

For easy and quick reference, the Owner's Manual is divided into:

- **INDEX:** index of topics.
- **FOREWORD:** aimed at providing general information about the Owner's Manual and about class certification and identification of the yacht.
- **GENERAL SAFETY RULES:** it indicates the general safety and fire prevention rules to be adopted during yacht use and maintenance; it contains the description of the safety equipment installed on board and specifies its proper use.
- **DESCRIPTION OF THE YACHT:** it specifies dimensions and main data of the yacht; it contains the description of the yacht in its main plans.
- **HELM POSITION:** describes the utilities present on the yacht's position.
- **ON-BOARD SYSTEMS:** it provides information about water systems, electric and government on board and their maintenance.
- **INFORMATION FOR USE:** it provides information about the proper procedures to be adopted when using the yacht, explaining the precautions to be taken and the proper way to carry out these operations respecting safety, the environment and the yacht itself.

## 1.5 SERVICE REQUIREMENT METHOD

The extensive RIVA service network is available to provide you with any information regarding issues not addressed by the manual. You can contact them:

RIVA AFTER SALES & SERVICE DEPARTMENT  
Via Ansaldo, 7  
47122 - Forlì (FC) - Italy  
Tel +39 0543 787511  
Fax +39 0543 473069  
customer.service@riva-yacht.com

RIVA has carefully selected all main components and accessories installed aboard your yacht, choosing among the most reliable manufacturers who, by offering a wide service network, also guarantee a speedy availability of spare parts.

Such components are covered by their own warranty released by the relevant manufacturers; any type of intervention shall be carried out by technicians authorised by RIVA; failing to comply with this prescription will void the warranty and may cause damage to the equipment.



### CAUTION

RIVA declines all responsibility for damages due to poor conservation and maintenance.



### DANGER

RIVA declines all responsibility concerning tampering carried out by third parties on equipment installed in the Shipyard. Such tampering or unauthorized installations will not only void the warranty, but may cause damage to the yacht and injuries to the people on board.

### NOTE

RIVA declines all responsibility for the installation and operation of electric, electronic or mechanical equipment improperly installed by third parties in a fashion not authorised by the Shipyard.

For all aspects regarding the warranty of the yacht, exclusively refer to what indicated in the sales agreement and in the warranty certificate which specifies all warranty conditions applicable to the purchased product.

Engines, winches, extractors and other equipment are guaranteed by the relevant manufacturers, who should assist directly or by means of their structures. If necessary, the RIVA After Sales & Service Department will support your requests in order to provide you with a quick service and to guarantee the respect of the applicable rules. When purchasing the yacht, the Owner should send the certificates to the relevant manufacturers for starting the warranty period; RIVA is not responsible for ensuing Warranty Certificates.

## 1.6 HOMOLOGATION CERTIFICATION AND IDENTIFICATION

RIVA present on the international market for many years, has always been concerned to build a product that is compliant, safe and of high quality and therefore subjects its yachts to the strict controls that the international authorities require in order to obtain a HOMOLOGATION CERTIFICATION.

Your yacht has obtained the RINA S.p.A. (REGISTRO ITALIANO NAVALE) homologation, which supervised the lamination of the hull, the reinforcement structures, the power system, the on-board systems and the safety equipment.

### 1.6.1 Yacht identification data

Manufacturer: **FERRETTI S.p.A.**

Model: **48 DOLCERIVA**

Type of yacht: **MOTOR YACHT**

Craft Identification Number (CIN): **IT-FERRDR44H526**

Design Category: **A**

This yacht is designed to operate in winds that may exceed wind force 8 (Beaufort scale) and in significant wave heights of 4m (13,1 ft) and above, and is largely self-sufficient.

Abnormal conditions such as hurricanes are excluded. Such conditions may be encountered on extended voyages, for example interoceanic, or near the coast, exposed to the wind and waves for several hundred nautical miles.

Classification: **“EC” conformity according to the requirements of Directive 94/25/EC as amended by 2013/53/EU**

Classification authority: **RINA (Registro Italiano Navale)**

Certification modules: **B+F+A1 (sound emission)**

### 1.6.2 Load-carrying capacity

- Maximum number of persons on board: **n. 10 (RINA classification)**
- Maximum load recommended: (people + luggage) = **1500 kg (3.307 lb)**
- Safety equipment: **n° 10 (standard)**
- Berths: **n° min 2, max 4** arranged as follows:
  - n°2** in the Owner's cabin (double bed) (standard)
  - n°2** in the guest cabin (single bed) (optional)
  - n°1** in the crew cabin (single bed) (optional)



#### **DANGER**

Do not exceed the recommended maximum number of people. Regardless of the number of people on board, the total weight of the yachts and their equipment must never exceed the recommended maximum load. Always use the seats and seats provided.

The Manufacturer's plate, installed under the helm position, which indicates the maximum yacht capacity.

The identification plate (CIN), which is attached to the starboard side of the transom, shows the craft identification number.



#### **CAUTION**

Manufacturer's plate - Part of the information is provided on the nameplate affixed to the yacht. A full explanation of this information is provided in the relevant sections of this manual.

Always keep the plate readable, and, if impaired, or tampered with, contact RIVA After Sales & Service Department.

Riva

DOLCERIVA

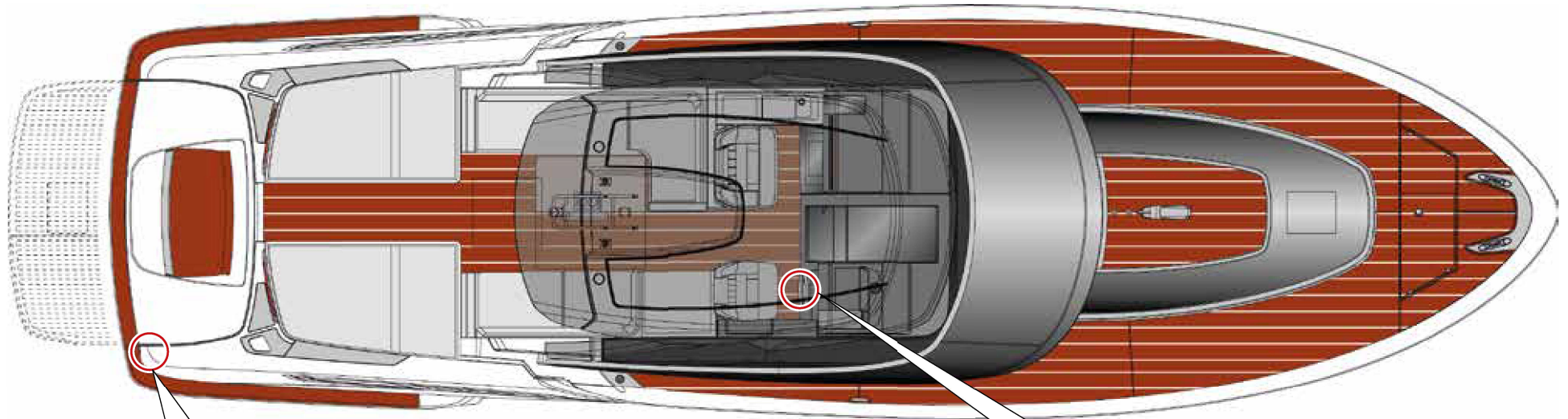

*Riva*  
**48 DOLCERIVA**  
Shipbuilder: Ferretti s.p.a.  
Design Category A

Max  =10  
Max  +  =1500 kg

  0474



*Riva*

DOLCERIVA

## 2 - GENERAL SAFETY RULES

## 2.1 GENERAL SAFETY RULES

Your yacht has been designed paying the utmost attention to all aspects regarding your safety and the safety of your guests. However, all personnel on board must be instructed and be made aware of some precautions to be adopted at all times.

For this purpose, it is advisable that all people on board carefully read the guidelines contained in this manual, as well as the signs (labels) installed on the yacht and, in particular, all safety notices.

The time spent in reading such instructions will prevent unpleasant accidents.

Remember that you are responsible for your safety and the safety of your passengers, and that you may jeopardize the safety of other yachts.

Therefore, please make sure you are perfectly aware of the main safety rules:

- During normal operation or any activities on the yacht, keep passage-ways and escape routes in proper conditions, in order to avoid hazards to people's safety;
- Always carry out routine inspections to verify the conditions of the yacht hull, machinery, safety equipment and systems;
- Always check the fuel level before navigation and compare the tanks' capacity with the engine consumption and the length and expected type of cruise;
- Check the expected weather conditions in the area you want to reach and along your course;
- In any case, always act according to common sense.

Safety is also "in the hands" of everyone on board, who should be instructed and be made aware of some precautions to be adopted all times:

- Moving on board requires some attention, since the stability of the yacht may be abruptly affected by the action of waves or sudden manoeuvres;
- People on board must know the location of all life jackets, the position of the fire-extinguishers and of the life-raft;
- All passengers must be perfectly aware of the risks caused by a fire, and the correct way to proceed in the event a fire should occur;
- All people on board must know what to do and how to behave in case they are to leave the yacht;
- The engine room must be properly ventilated when the engines or the generator are running or in the cooling phase; air intakes, therefore, must always be open and free from obstructions.
- Access to the engine room must only be allowed to authorized personnel, aware of possible dangers generated by:
  - Moving mechanical parts;
  - Hot parts and components;
  - Circuits with pressurized, hot or irritating fluids;
  - Circuits with flammable fluids;
  - High noise levels when engines are running;
  - Risk of unintentionally operating controls or valves that are important for the safe conduct of the yacht.

Do not tamper with, disconnect, eliminate or by-pass the safety devices installed on the yacht. Periodically have the efficiency of the equipment inspected and tested by expert and authorised personnel, in order to ensure operation in case of need. Failure to meet such requirements may lead to serious risks for the health and safety of your passengers and of your yacht.

**CAUTION**

Personnel performing any type of operations, maintenance, repair or other service during the lifetime of the yacht must be technically qualified and have proven abilities and experience acquired and recognized in this specific field, and follow the instructions of the equipment manufacturer. The lack of such requirements may cause damage to the yacht and jeopardize the safety of people.

Make sure any parts not stored or not secured correctly, cannot move during navigation, hinder the passage, prevent the opening of inner hatches, fall against the people on board, damage or hinder quick finding of necessary tools in case of emergency.

**DANGER****Carbon monoxide**

Incomplete combustion of fossil fuels produces a huge quantity of carbon monoxide, which is a very toxic and dangerous gas, as it is colourless and odourless.

When the engines and/or the generator are running, the yacht must be properly ventilated, in particular if underway at low speed, or when the exhaust fumes may blow back on board (e.g. when the yacht is shored or anchored or riding the anchor).

**DANGER**

Only the personnel having a regular license or the necessary qualifications can steer this yacht.

Personnel operating the yacht must not be under the influence of alcohol, drugs or narcotics.

**DANGER**

It is strictly forbidden to stay on the weather decks outside the protected areas (i.e. aft platform) during navigation.

**DANGER**

When the yacht is being loaded, never exceed the maximum load carrying capacity. Always take great care when loading the yacht and try to distribute the loads evenly so as to keep the correct trim.

Avoid placing heavy loads in the upper part to not reduce the stability.

**CAUTION**

Always place the necessary attention while navigating, especially in adverse weather conditions or breaking waves.

### 2.1.1 Use-related rules

Your yacht has been realised with the utmost care by RIVA to grant the best possible reliability and safety to the persons on board.

It is anyway necessary to remember that these conditions, even if necessary, are nevertheless not sufficient, as reliability and safety are based upon strict and continuous observance, by the Owner and his/her Guests, of the so-called "On-board Ethics".

"On-board Ethics" means all those behaviour rules which all persons on board must strictly observe in order not to jeopardize the product that the Builder realised with so much care and professionalism.

Naturally, behaviour rules to be observed on board differ depending on the activity to be carried out.

For example, the Captain is allowed to carry out manoeuvres through the equipment on the helm position and to access hazardous areas being aware of the risks; on the contrary, persons not allowed to operate the steering equipment or to access dangerous areas must be instructed in not staying or passing there for any reason.

Distribute loads so as to maintain the correct trim, do not overload the yacht, especially at bow and stern.

Observe the rules to prevent a sea collision and the speed limits, moreover pay always the highest attention during navigation.

The Captain, after having duly collected information on the yacht's operation and controls, should at first try and simulate some test manoeuvres with the aid of the Shipyard personnel, to familiarize with the controls and be aware of the typical reactions of this yacht.



#### **DANGER**

The Owner is the sole responsible for driving the yacht.  
Prior to departure, the Owner must ensure that the safety equipment required by law is present on board and perfectly working.

The main operational steps, such as getting underway, navigation, anchoring and mooring must be carried out and verified scrupulously. In particular, all pre-departure procedures must be strictly followed.

All refuelling phases must be carried out taking all the precautions necessary to guarantee safety and to prevent even the smallest spillage of products which could pollute the surrounding environment.

When navigating near harbours, beaches and shores, observe the directives issued by local port authorities, particularly as to the speed; high speed can originate waves which can jeopardize the safety of the environment and of people.

Before lowering the anchor in free waters, check if it is allowed and verify the type of sea bottom, to prevent damaging or upsetting the surrounding marine habitat balance.

When entering and exiting, make sure that steps, handles and shoe soles are clean and dry.

In order to prevent the risk of injury, the instruments in the helm position must only be used from the correct piloting position.

**DANGER**

At high speed, the use of the autopilot is dangerous and not recommended. Even when the autopilot controls the route, maintain a proper watch on navigation at all times.

**DANGER**

Do not use the yacht if the safety equipment is inoperative. Failure to meet this requirement may originate serious risks for the safety of your yacht and of your passengers.

**CAUTION**

Close portholes, windows and skylights during navigating, especially in poor weather conditions. Also, make sure that you have closed or locked doors to prevent collisions with objects or people.

**CAUTION**

Avoid sudden manoeuvres at speed.

**CAUTION**

For safety and comfort reduce yacht speed over waves.

**CAUTION**

Any changes in the distribution of the masses on board, such as the addition of weights on top, a structure or the replacement of components with different specifications, can significantly affect the stability, trim and performance of the yacht. In these cases, contact RIVA After Sales & Service Department.

### 2.1.2 Maintenance rules

In this section important information is given to enable you to operate the various components of the yacht without any hazard.

Besides the warnings given below, specific warnings have been distributed in the whole manual. This section is meant to give a safety code of behaviour for the operation and for maintenance procedures.

Periodical maintenance, including daily inspections, are important to keep the equipment/components in the best possible efficiency conditions; failure to comply with a proper maintenance schedule may degenerate causing a decrease in performance reliability and a shorter life. Furthermore, failure to observe the maintenance schedule leads to unexpected problems that can decrease safety at sea.

Therefore, you must read and understand the information given in the various related technical manuals delivered before acting and operating.

If you are not sure about something concerning the work to be done, refer to Riva After Sales & Service Department or to the one of the equipment's manufacturer.



#### **DANGER**

Always operate with caution, care and under safety conditions.



#### **ENVIRONMENT**

Any maintenance operation must be carried out in the strict respect of the surrounding environment. Take all necessary measures to avoid that even one single "oil drop" may be spilled: the protection of our environment starts with this type of attention.

#### **NOTE**

In particular, according to the regulations in force, place warning signs in the areas that can be affected by the activity and prevent access to any device or equipment that, if enabled, could cause hazardous conditions endangering people and/or property on board.

Maintenance and adjustment operations must be carried out by qualified, authorized personnel who must use all necessary protections according to the regulations in force.

All maintenance operations requiring precise technical knowledge or particular skills must be carried out exclusively by qualified personnel with recognised experience, acquired in the specific field of intervention.

Persons performing maintenance operations in barely accessible or dangerous areas must provide for their own safety and that of any other persons involved, in compliance with existing workplace safety regulations. If necessary, wear individual protection means required by the task to be performed.

During navigation, access to the engine room must be limited to authorized and properly equipped personnel only.

Inspect the sea water system inlets and outlets as well as the bilge systems. These checks are vital to ensure yacht buoyancy.

Do not perform any maintenance operations or adjustments other than those indicated and/or suggested by the Manufacturer. If necessary, contact RIVA After Sales & Service Department for more precise instructions.

**NOTE**

Keep all yacht's components clean by following the procedures and using the specific products suggested by the Manufacturer.

Use oils and greases recommended by Manufacturer. This will ensure yacht functionality and the expected safety level.

Only replace worn parts using original spares.

Carefully read the instructions for use before performing maintenance or starting the yacht or any component.

**DANGER**

The use of faulty lifting attachments can be the cause of accidents; check therefore their efficiency. Ensure the compliance of hoisting gears with local norms and their suitability for the job to be performed.

The use of unsuitable clothing can cause accidents; do not wear flapping clothes that could be easily caught by the moving parts of the yacht. Wear protective clothes suitable with the kind of work to carry out (helmets, safety shoes and protective goggles, overalls). Button up the cuffs, do not use ties or scarves and do not leave your long hair loose.

It is extremely dangerous to operate the yacht controls under the influence of alcohol or drugs. Keep off from taking alcohol or drugs before and during the work. Do not take drugs which could cause drowsiness.

Insufficient information may cause accidents. If two or more persons are working simultaneously on the same machine, make sure that each of them is aware of the operation carried out by the others. Therefore, prepare a working plan so as to avoid any interference or hazard.

Before starting an engine, get other persons away from hazardous areas. Failure to comply with these precautions may cause serious injury, and even death.

When performing maintenance operations inside the engine room, you must make sure that the engine cannot be started from the helm position by unauthorized persons.

**DANGER**

Keep the whole working area free of oil and grease stains, especially the area around the engine, the walk-around and the ladders. Injury due to slipping may have serious consequences.

Oil leakage at operating pressure can cause injury: before disconnecting or connecting the hoses, stop the engine and operate the controls to release the residual pressure. Prevent the engine start when the hoses are disconnected.

When the outer temperature falls below 4°C (39,2°F) inside the ducts where water flows, there is the risk that the water freezes inside them and, thus, that breaks occur.

Gaskets and O-Rings assembled in a wrong way and/or damaged and/ or worn out may cause leaks or damage; replace them immediately.

**DANGER**

The battery produces explosive fumes; do not approach with flames and sparks nor smoke in its vicinity. If the battery is used or charged in a closed area, make sure good ventilation is provided. Do not check the battery charge by short-circuiting the terminals with metal tools (the battery may explode): use a density gauge or a battery tester. The electrolyte contained in the batteries is extremely corrosive: while charging or handling of the batteries, we recommend protecting your skin, eyes and clothing. Always use safety glasses and gloves. If the electrolyte gets into contact with the skin, rinse as soon as possible by washing with water and soap. If eyes are involved, immediately rinse with plenty of water and then ask for medical assistance.

Move away from the working area or adequately protect possible flammable materials, which could catch fire from sparkles.

Possible sparks produced by the electric system may cause explosions and fires. Avoid starting the yacht in the presence of flammable materials, liquids, vapours or flammable powders.

Fuel is flammable and explosive: do not approach with flames, do not smoke while refuelling or while working on the engine. Carry out refuelling with engine shut off. Failure to comply with these precautions may cause fires with hazard of serious damage to property and injury to persons.

**DANGER**

Suspended loads may fall and injure you. Do not walk or work under lifted devices not sufficiently and safely supported.

Due to moving mechanical parts, when working on the shafting and on engine parts, absolutely prevent starting of the latter.

**DANGER**

Before performing tasks on the electric system, always cut OFF power supply on the whole system or on the component on which you are operating, in order to prevent risks of shocks or electrocutions.

If necessary, first disconnect the negative cable from the battery and then connect it last to prevent short circuits.

**DANGER**

Precautions to safeguard your health:

Oil, fuel and antifreeze are toxic substances: do not swallow.

These substances also contain dangerous contaminating agents which may cause damage to the skin.

Protect your eyes from accidental splashes of toxic substances by using safety goggles.

Store products and technical fluids for yacht operation (such as anti-freeze) only in containers that cannot be mistaken for beverage holders.

Due to long and repeated contact with engine oil of any type, the skin can degrease and dry out with consequent irritation or even inflammation.

**DANGER**

Nevertheless, if all basic rules for protection at work and hygienic rules are observed, no harm for health can be expected even if handling old engine oil.

- Avoid long and repeated contact of the skin with toxic substances.
- Protect the skin with suitable protective products or with safety gloves.
- Clean the skin by washing it thoroughly with water and soap. A valid help can come from special hand detergents and a brush. Do not use any fuel, thinners or solvents to clean the skin.
- After cleaning, treat the skin with special greasy cream.
- Change oil-soaked clothes and shoes.

**DANGER**

If, notwithstanding precautions, injury should take place, in particular due to contact with caustic acid, penetration of fuel in the skin, scalding from hot oil, antifreeze splashes in the eyes, etc., immediately require medical assistance.

**DANGER**

Coolants are hot. When engine temperature is high, the cooling system is under pressure and, by removing the heat exchanger plug, the hot liquid can come out as a jet! Therefore, wait for the system to cool down before removing the plug, and then very slowly turn it up to the first notch and release the system pressure.

During operation, as a precaution, always cover the plug with a rag.

**NOTE**

RIVA declines all responsibility for the installation and operation of electric, electronic or mechanical equipment improperly installed by third parties in a fashion not authorised by the Shipyard.

RIVA declines all responsibility concerning tampering carried out by third parties on equipment installed in the Shipyard. Such tampering or unauthorized installations will not only immediately void the warranty, but may cause damage to the yacht and injuries to the people on board.

RIVA declines all responsibility concerning periodical maintenance activities scheduled by the Shipyard or by Manufacturers, but not carried out, on equipment/components, for which it is necessary to refer to their own Technical Manuals.

## 2.2 FIRE PREVENTION RULES

Before steering a yacht, the Owner must be perfectly aware of and trained on the following fire prevention measures.

The yacht must always be equipped with portable extinguishers, located as shown in the figure "Arrangement of safety equipment".



### DANGER

On all yachts, fire is a major danger.  
All fire prevention measures must be followed scrupulously.

The yacht's Owner is directly responsible for:

- Having fire-extinguishers and fire-fighting systems overhauled by the date shown on the labels of each single extinguisher and have them replaced, as required by the rules in force, with other extinguishers of equivalent or even higher capacity;
- Informing the crew about the location and use of fire extinguishers and fire-fighting systems and escape routes;
- Ensuring that fire extinguishers are also available in the passengers' cabins.

### NOTE

The engine room is equipped with a gas fire-fighting system!



### DANGER

Never:

- Obstruct passageways and the escape routes;
- Hinder access to safety devices, such as fuel valves, electrical switches, etc.;
- Obstruct access to fire extinguishers stowed inside the lockers;
- Leave the yacht unattended, when burners or heat generating equipment are on;
- Use naked flames;
- Modify electric or fuel supply systems, without consulting RIVA After Sales & Service Department beforehand;
- Smoke near or when handling flammable materials;
- Stow highly flammable materials (such as fuel, thinners, etc..) in proximity to heat sources, such as engines, galley, etc.;
- Stow flammable material in the engine room. Non-flammable materials may be stowed only if properly rigged, so they do not accidentally come into contact with rotating engine parts, or obstruct access to the engine room;

Keep bilges clean and check frequently for oil and fuel leaks.

### NOTE

Carefully read the prescriptions regarding the fire-extinguishing system and its use.

**DANGER**

In case fire breaks out in proximity to electrical equipment, do not use water, use the manual dry-powder fire extinguishers only. After using the extinguishers, leave and ventilate the area immediately before re-approaching it, in order to prevent asphyxia and physical harm.  
Clean out any fire extinguishing powder out very carefully.

Besides the above-mentioned rules, RIVA recommends the following:

- Avoid smoking lower deck, especially in the engine room.
- Avoid dropping liquids in the bilge; keep it clean, especially the bilge of the engine room.

In case of fuel leaks from the engines or from the generator, operate as follows:

- Stop all engines immediately;
- Locate the leakage and, if possible, repair it after closing the delivery valves;
- Dry and clean the bilge before restarting the engines.

In case of fire, follow the procedures described below:

- Keep calm and do not spread panic among the passengers;
- Stop the yacht, and close the sea cocks and the overboard drains;
- Stop all pouring operations of flammable liquids;
- Locate the fire and its origin;
- Avoid breathing smoke;
- Extinguish the fire, following standard fire extinguishing techniques.

**NOTE**

The Captain of a pleasure yacht must be perfectly aware of the basic fire fighting techniques and how to use the extinguishers.

**DANGER**

In case of fire on board, try to electrically insulate the area concerned by disconnecting all AC and DC input magneto-thermal switches to avoid feeding fires and short circuits.

**DANGER**

In case of the risk of the yacht sinking, close the fuel and black waters valves.

**WARNING****EXPLOSION HAZARD**

Any lithium battery powered device on board must be recharged only in open air areas, connected to a suitable charging system.  
Also please refer to the device dedicated Use and Maintenance Manual.

**NOTE**

The reading of this section, containing all the information the Owner of the yacht should know, is strongly recommended.

### 2.2.1 General fire prevention rules

A regular and correct maintenance of the systems and a cautious behaviour of all passengers are indispensable measures for preventing any risk of fire. Over 90% of the probabilities of fighting a fire successfully, depends on the ability to prevent and avoid any condition that may favour a fire to spread.

The small remaining percentage depends on the crew's reaction ability, and most of all, their rapidity to enter into action.

Nearly all fires, if early detected, can be extinguished easily.

For these reasons, it is necessary to carry out preventive surveys on a regular basis and identify all possible fire sources, and in particular:

- Check the proper operation of all main equipment/systems;
- Visit all compartments and in particular the engine room frequently;
- If a system does not work correctly, identify the failure and take the appropriate corrective actions;
- Operate all systems and equipment as specified;
- Not stow on-board flammable materials where not expected.

If a fire is detected, determine and remove the cause, if possible, (e.g. in case of a short-circuit, cut-OFF the electrical system), extinguish the fire promptly and be vigilant to make sure that the fire does not break out again.



**CAUTION**

Never use water jets to extinguish fires on electric or electronic equipment.

**NOTE**

The ability to operate the fire extinguishers properly can ensure the success of the operation.

It is vital that the fire fighting operations are performed by people competent in this type of emergencies.

It is anyway necessary to be aware of the minimum fire-prevention and fire-fighting rules; the first defence is to prevent fires before they start spreading.

The following table contains the classification of the fire types:

**Comparison between fire classes**

America	Europa/Australia/Asia	Fuel/Heat source
Class A	Class A	Ordinary fuels
Class B	Class B	Flammable liquids
	Class C	Flammable gases
Class C	Class E	Electric appliances
Class D	Class D	Combustible metals
Class K	Class F	Cooking oil or fat

It is very important to use the correct extinguishing agent according to each fire class; normally, water can be used only for class A fires, together with chemical extinguishing agents (portable or fixed devices).

### 2.3 DANGEROUS AREAS

On board the yacht some areas are “dangerous“, and need plenty of care, and possibly require wearing protective equipment, in order to safeguard the integrity of people on board.



**DANGER**

During navigation, the risks relating to any hazardous area increase significantly; we recommend scrupulously observing the safety rules indicated in this manual.

The areas are following:

- Engine room: area with a high level of noise, presence of moving components, hazard of burns, hazard of stumbling and falling. The access to the engine room is only allowed to trained and expert crew, prepared for the risks and equipped with proper safety devices, if necessary;
- Stern platform and bow area: outer area not protected by rails against falling into the sea. During navigation the access to this area is forbidden. Accessing and staying in this area is allowed only when the yacht is idle and with the engines shut off.

When underway, passengers can stay in the cockpit, preferably remaining seated. When moving, passengers shall use the special handrails installed in the cockpit.

In case of fall overboard, following rescue devices can be used:

- Life buoy;
- Life vests.

For going back aboard, the easiest way is the stern platform using the stainless steel swim ladder, which is stored in the starboard stern hatch when is not used.

The following diagram marks out the dangerous areas, with different colours according to the risk level (red = extremely dangerous area), where utmost care must be paid.



**DANGER**

Be careful when the deck is slippery. Do not walk on the deck in case of bad weather, when the deck is wet, without shoes with rubber sole or when the yacht is moving.

**NOTE**

It is responsibility of the Captain to inform all persons on board about dangerous areas when they exist, possible areas temporarily forbidden when maintenance operations are being carried out, as well as about the correct behaviour to be adopted in the above-mentioned areas, also according to weather and sea conditions.



**CAUTION**

All the areas where there is polished fibreglass are no-step areas.



**DANGER**

The captain is responsible for ensuring boarding with the ladder extracted every time the yacht is not in operation (meaning not navigating) although attended.

2.3.1 Dangerous and forbidden areas

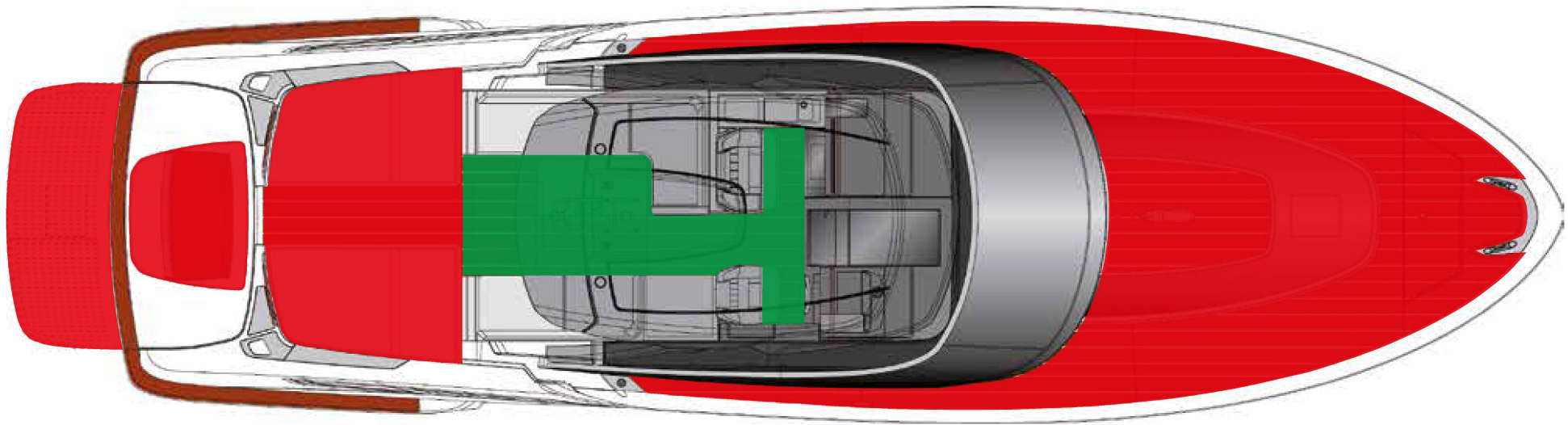

 Forbidden areas

 Working deck

The side walk-arounds, the bow deck and the stern platform, highlighted in red, are not considered as “working deck”.

Standing or walking is allowed in this area, highlighted in green, during navigation, while it is forbidden to stand or walk on the cockpit seats.

## 2.4 NOTES ON THE ENVIRONMENT

Environmental pollution is caused by three kinds of polluting agents:

- Water;
- Air;
- Soil.

Non oily and black waters (containing only human organic waste) can be discharged into the open sea. In the harbour areas they should be collected into suitable containers and afterwards discharged either during navigation into open sea or by means of special drainage systems fastened to the shore or wheel-conveyed.

Soil pollution is also caused by discharging waste at shore.

International rules for pleasure yachts essentially prescribe the following:

- During navigation it is forbidden to discharge any non biodegradable product, either of food or commercial origin, into the open sea.
- In the harbour, normal waste is considered urban waste that must be hermetically sealed in plastic bags and thrown into waste dumpsters.
- Special waste must be disposed of in suitable containers or, if these are not available, it must be delivered to local waste disposing areas, in compliance with the rules in force, issued by the local Port Authority.



### ENVIRONMENT

During navigation, do not dispose any on-board waste at sea, but keep it and dump it on waste containers ashore.

Remember that it is forbidden to dump oils and fuels into the sea; therefore, it is recommended to clean the engines' bilges by using absorbent materials to be disposed of later on into dedicated containers.

- The following waste is considered special waste:
  - Water and oily mixtures (e.g.: bilge water);
  - Oils (fuel, additives and lubricants);
  - Poisonous chemical substances (like battery acids, paints, thinners and the relevant containers);
  - Spray cans containing C.F.C. gas;
  - Batteries;
  - Spent flares;
  - Expired pharmaceutical products;
  - Products containing lead or asbestos;
  - Etc..
- Fuel and oil leaks;
- Waste discharge and disposal;
- Excessive noise;
- Wake / wake from board;
- Exhaust fumes;
- Paints, detergents and other agents.

Please remember that, according to legislation, until such waste is delivered to suitable disposal areas, you will be considered as possessors and therefore indictable in case of unlawful discharge.

Should specific cases be missing in the harbour area, the Authority in charge for the disposal is the Port Authority section "Waste Disposal".

## 2.5 REGULATIONS FOR WASTE DISPOSAL

MARPOL 73/78 is the international convention governing the prevention of pollution from ships.

Those standards apply to all yachts with no limits on tonnage and service, therefore including all pleasure yachts.

The rules cover the entire Mediterranean.



### CAUTION

When moored in a harbour, always check that your yacht is not a source of pollution. The environment must be respected and safeguarded, preventing risks for the life of aquatic flora and fauna. It is good practice to leave no trace behind you, to respect laws on safety and environmental protection. Do not discharge bilge waste, oily residues, fuel or other liquids overboard. Dispose of solid waste and old engine oil in the containers provided at mooring points.



### CAUTION

During navigation, it is always necessary to behave suitably and to respect the safety and the comfort of your guests and of persons on nearby yachts. Therefore:

- Avoid excessive noise;
- Do not leave the engines running for long periods without moving OFF;
- Do not navigate at high speed or beyond the permitted limits when leaving or entering harbours, marinas, etc., to prevent causing excessive wash or wave motion.

Although discharge at sea, except in special areas, of a wide range of ship-generated garbage is permitted at specified distances from the nearest land, preference should be given to disposal at shore reception facilities.



### CAUTION

It is absolutely prohibited to throw plastics, synthetic cables, fishing nets, waste bags, floating packaging materials, paper, rags, metals, bottles, galley utensils and similar waste into the sea. Ungrounded food waste can only be disposed of beyond 12 miles.



### CAUTION

It is forbidden to use toilets or holding tanks near the shore or in any prohibited area. Use the facilities of the suction port or marina to empty the holding tank before leaving the port.



### ENVIRONMENT

Always consider and comply local and international laws against marine pollution (MARPOL). Moreover, it is always necessary to respect the rules of good conduct yacht.



### CAUTION

Within the 12 nautical miles off the coast it is forbidden to discharge the black water tank at sea: it is necessary to keep the exhaust pump off, excluding the activation automatism if present. Refer to the owner's manual.

## 2.6 ESCAPE ROUTES

In order to cope with the different emergency situations that could require the abandonment of the yacht (fire, collision with sinking hazard, etc..) in the quickest and safest way, the rules in force require an "escape plan" informing about the safest as well as quickest paths for taking shelter and reaching the "muster stations", located outdoors, from which it will be easier to leave the yacht.

The diagrams shown hereunder indicate the escape routes and the paths to be used in case of need.



**CAUTION**

Always keep the escape routes, dry, free and accessible.



**CAUTION**

The ladders must be carefully used during navigation.



**CAUTION**

During navigation it is necessary to unlock the safety retainer of the bow skylight.



**DANGER**

The on-board personnel must ensure that escape routes and paths are always free and accessible.

**NOTE**

All people on board must be aware of the risks and dangers that they can meet when aboard the yacht.

In particular, they must know which are the safest escape routes under different emergency conditions.



**DANGER**

While underway, the access to the technical cabin is restricted only to qualified personnel.



**DANGER**

According to the nature and position of the danger or fire source, to choose very carefully the safest and most suitable escape route.

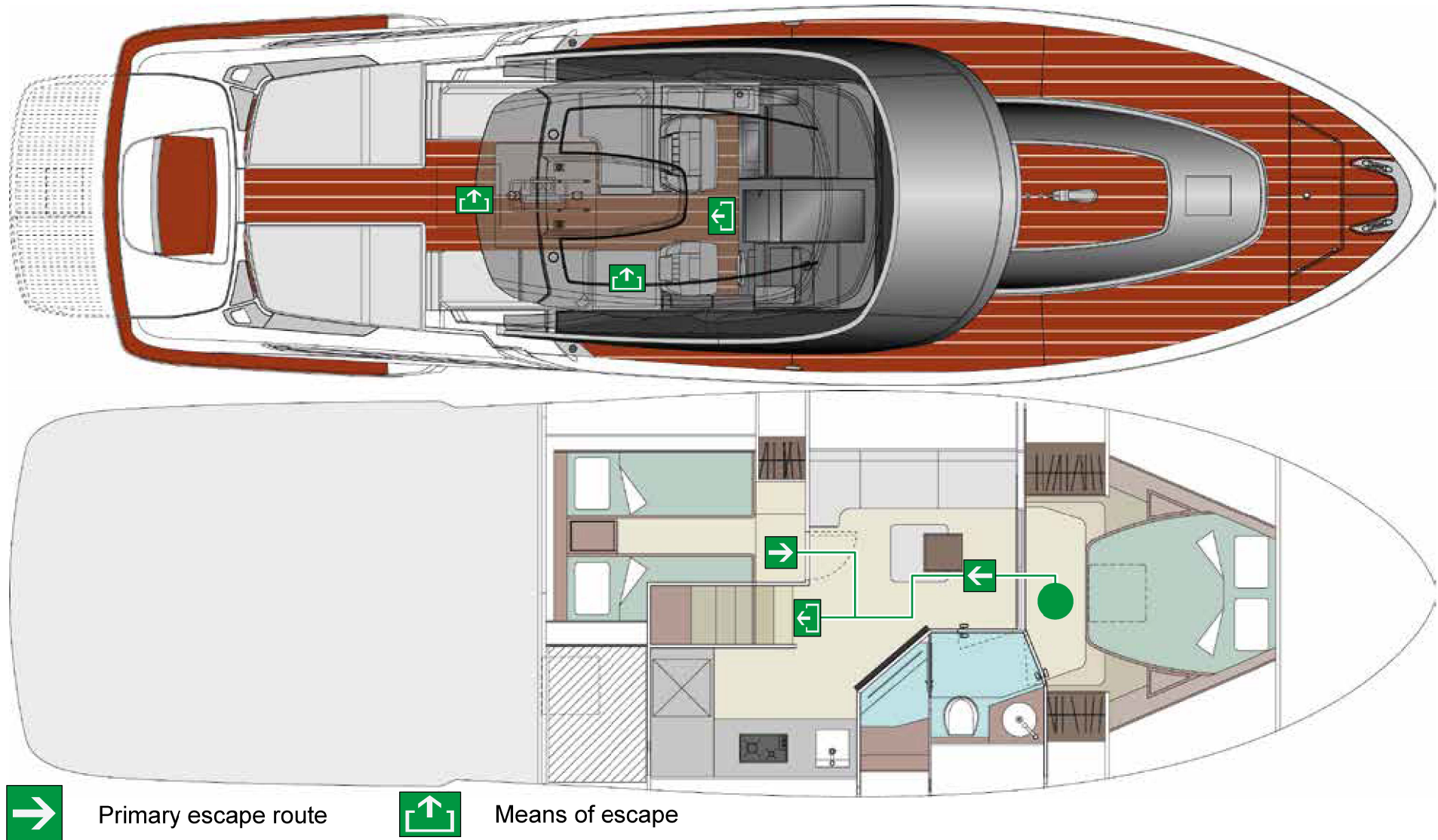

## 2.7 SAFETY EQUIPMENT

RIVA has equipped your yacht with specific equipment to ensure guarantee the highest possible degree of safety even in the most dangerous situations. To ensure its effectiveness, however, all passengers must know the location and proper use of the safety equipment.

The on-board safety devices are:

- N°10 individual life jackets, stored in an easily accessible location;
- N°1 type-approved life buoy, equipped with floating non-wrapping line and tilting light-emitting buoy;
- N°1 self-inflatable life raft with 10 seats;
- N°3 portable dry chemical fire extinguishers, stored in various locations of the yacht, indicated by an appropriate plate;
- N°1 gas fixed extinguisher HFC227 in the bow engine room bulkhead for its protection;
- N°1 VHF radiotelephone installed in helm position.



### DANGER

The above-mentioned safety systems must comply with the existing local and international navigation regulations, and must be periodically inspected by specialized companies and qualified technical personnel, prior to the expiration date indicated on the systems.



### CAUTION







The Captain is required to inform the crew on the yacht about the safety equipment, whether in case of fire or in case of sinking and listing.

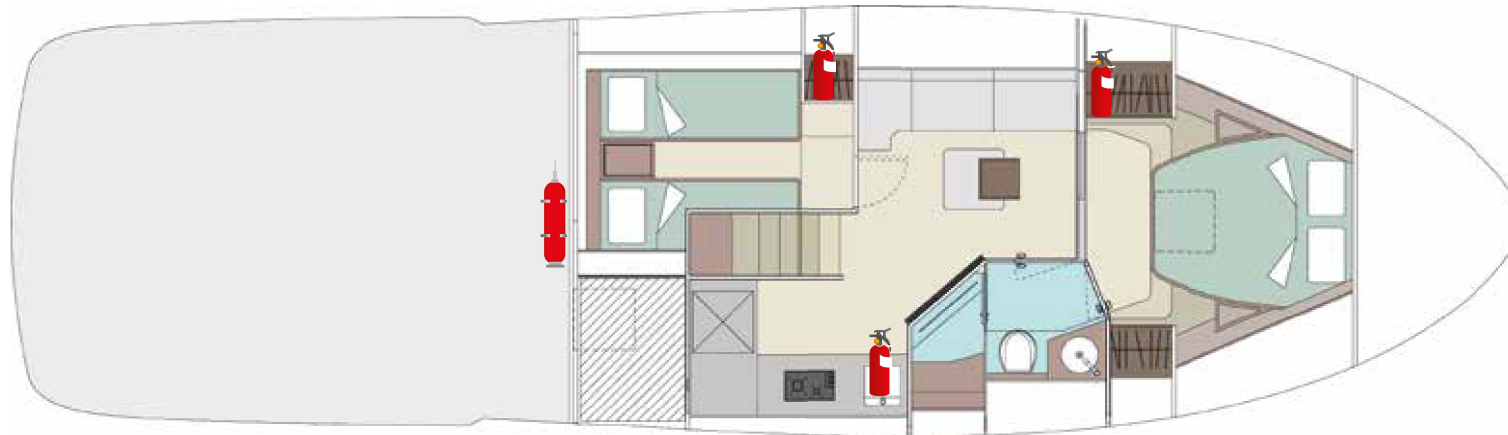
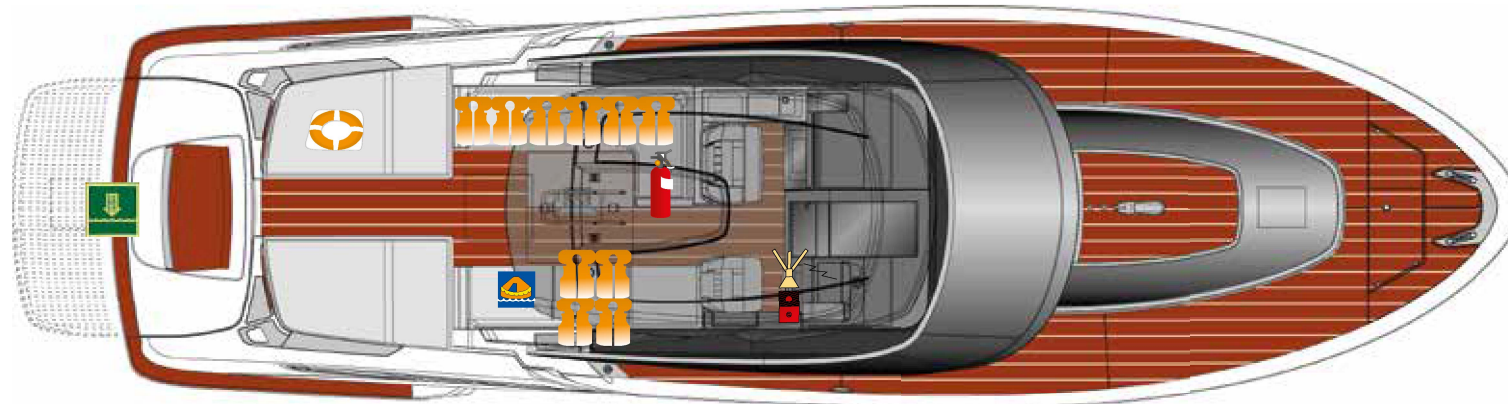

### CAUTION

The diagram indicates the positioning provided by the manufacturer for the various safety equipment; it represents therefore a reference as to position and code. The Owner is responsible for the updating and ranking of the various safety equipment in compliance with local, national, and international laws.



-  Self-inflatable life raft
-  Individual life jacket
-  Fixed gas fire extinguisher
-  Emergency boarding system
-  Life buoy
-  Portable dry-chemical extinguisher
-  VHF-Radiotelephone

### 2.7.1 Safety plates

The plates applied on the yacht are used to point out special risks: each plate is located on the part of the yacht which can be a source of risk.

Before working with or on this part of the yacht, read the safety warning carefully.

Keep all the plates clean and readable, replace them if missing or damaged.

The fire extinguisher  plate is located adjacent to each fire extinguisher.

### 2.7.2 Emergency boarding system

Recover a man overboard before possible hypothermia or drowning. The time of permanence afloat depends on critical conditions of the water, on swimming capacity, on the presence of bulky clothing, intoxication, possibly injury and debilitation. Recovering a man overboard depends on the capacity of manoeuvring the yacht (knowledge of the yacht's speed and turning capacity) and on the experience concerning rescue procedures.

Rescue is a combination of actions: reach the man overboard, establish a contact and bring him/her on board.

- Keep a visual contact with the man overboard.
- Slow down and go towards the man overboard. At night, direct the best light source available towards the man overboard.
- Launch the life buoy into the sea, towards the man overboard, and fasten it to the yacht by means of a line. It shall be used as a further reference to the rescuers.
- When approaching the man overboard, stop the yacht or slow down.
- When you are near the man overboard, stop the engines with the gear engaged, in order to avoid that the propellers continue rotating.

Help the man overboard board the yacht. The person shall generally board the yacht from the stern, through the boarding system **(1)**. If the man overboard is injured, an expert rescuer may wear some floating rescue equipment.

**NOTE**

The operating yacht, when anchored, shall have the swim ladder extended.

**NOTE**

If the victim presents drowning symptoms, give specific assistance. In case of serious danger, immediately make a distress call.



**WARNING**

In case of fall in the water, to go up on the yacht, use the special handrails positioned aft.



## 2.8 USE OF THE SAFETY EQUIPMENT

### 2.8.1 Self-inflatable life raft

The self-inflatable life raft must be used only in case of real emergency implying the abandonment of the yacht.

The yacht must in fact be abandoned in case of serious sinking hazard, or in case of fire out of control.

In all other cases it is necessary a careful evaluation, because to leave the own yacht, even though on a self-inflatable life raft, could mean a more difficult identification on the side of the rescue team.

As a matter of fact, the search for the shipwrecked will start exactly from the last known position of the yacht.

#### NOTE

The validity of self-inflatable life raft is limited; check its expiry date on the certificate provided by the Manufacturer.

#### NOTE

Self-inflatable life raft can be overhauled at authorized Centres that shall extend the validity of the certificate. Sanctions are provided if this rule is not respected.

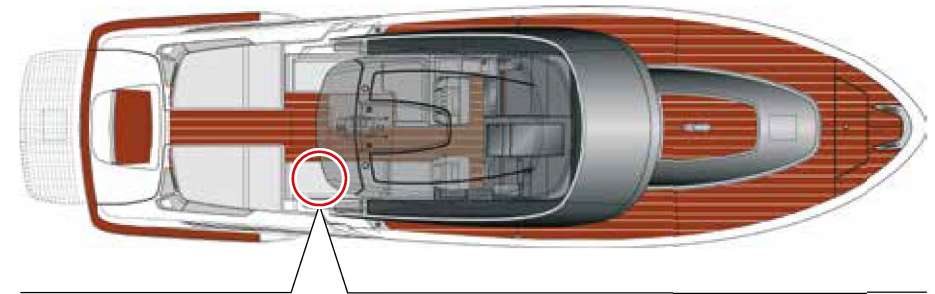

In case the use of self-inflatable life raft becomes necessary, perform the following operations:

1. Stop all yacht engines and wear the individual life jackets.
2. Perform the distress call using the VHF device.
3. Remove the cushions (seat and backrest) of the cockpit's starboard side sofa, and open the hatch.
4. Unwind the line of the life raft for 3 or 4 meters (9,8 or 13,1 ft); fix it tightly to a fixed point of the yacht to throw the self-inflatable life raft overboard downwind.
5. Fully uncoil the line and give a strong pull: the raft shall inflate automatically.
6. Proceed with the boarding of all personnel on the raft, directly from the yacht.
7. If the distress call has already been made and you have received an answer, prepare for a relatively short wait; therefore, evaluate whether to cut the life line or not. If you did not have the time to make the distress call or you did not receive an answer, prepare for a long wait; in this case, plan for survival, taking the following items, as well as the equipment included in the kit: floating smoke signals and rockets, a knife, drinking water and energy foods that do not cause thirst. Before getting aboard the life raft, wear all possible clothing, except for shoes that could harm the other shipwrecked persons or damage the raft;
8. If some passengers have fallen overboard, help them up into the raft; use the life buoy equipped with the line, if necessary.
9. Make sure that all the personnel is on board and assess if it is better to cut the connecting line or not.
10. Extract the knife supplied with the raft from its sheath and use it to cut the connecting line that secures the self-inflating raft to the yacht.
11. Rapidly row away from the yacht using the oars provided with the raft.
12. Close the protective sheet in case of bad weather; this is useful to keep inside the warmth generated by the occupants and to keep outside the cold and humidity during night hours or in case of bad weather; only keep a small opening to provide ventilation.



## DANGER

A life raft cannot reach the shore with its own means, unless it is driven by favourable winds. Oars are only useful for small manoeuvres.



## DANGER

All persons on board must know the location of self-inflatable raft storage and the correct use procedures.



## DANGER

If the life raft does not open after the first pull, repeat the operation 2 or 3 times. If it still does not open, enter in the water and pull the emergency line strongly while keeping a hand on the container. If it still does not open, use a blade to force the container open and activate the opening system by directly pulling the line.  
If the raft opens upside down, enter in the water and turn it over by pulling the appropriate line.

Always wear individual life jackets, especially with rough sea.

If the raft deflates, inflate it again from time to time using the proper inflating device provided with the raft.

If the raft is pierced, use the sealer contained in the repair kit, so as to prevent air escape.

It is also possible to carry out small repairs using the glue provided with the kit.

To that end, clean the ruptured part and the repair patch; spread both of them with the glue provided in the kit; apply the patch for 30 seconds pushing outward from the center to remove air bubbles; keep pushing for a while; inflate approximately one hour later.



## **DANGER**

With very high waves and strong wind there is the risk that the raft may overturn: shift the weight of persons on board towards the side tending to lift. If the life raft does capsize, roll it over and return on board.

## 2.8.2 Portable fire extinguishers

In order to supply an easy, ready and quick fire-fighting system on board of your ship, portable fire extinguishers have been set, designed to be carried manually, and in compliance with the rules in force.

The fire extinguishers have been placed in visible and easily accessible positions, and the position is indicated by special plates applied by RIVA.

In case a fire breaks out, immediately reach a fire-fighting station where a portable fire extinguisher is located.

The use of a fire extinguisher requires a certain familiarity with it, but some theoretical-practical rules can facilitate its handling:

- Make sure that the safety pin (1) against accidental discharge, has been removed;
- Always direct the extinguisher towards the bottom of the flame;
- Do not stand but try to bow as far as possible;
- Do not hit the fire from above;
- Shift the fan-shaped jet slowly from one side to the other of the flame;
- Act immediately before the temperature becomes too high;
- Always stay windward;
- If the material burnt is wood, paper or tissue, after the fire has been extinguished, pour on water to prevent any further spread of flames;
- Always act dressed, avoiding loose clothing or similar;
- Head the yacht so that the fire is leeward;
- Persons not engaged with the fire fighting must gather windward from the fire area and if necessary, disembark on a rescue device (tender, rubber dinghy, self-inflatable life raft), that must be linked to the yacht with a line, in order also to embark the persons engaged with the fire fighting;
- If the fire is big the operators must abundantly wet their clothing;
- The engines must be shut-off immediately and the fuel must be cut-OFF;
- Isolated objects in flames must immediately be thrown overboard;
- All openings that can allow air to penetrate through the flames must be closed;
- After using the extinguisher to fight fire in closed spaces, ventilate the space carefully, prior to entry, and remove powder deposits.



**DANGER**

The person in charge of the yacht must make sure that all passengers know the locations and how to operate the fire extinguishers on board correctly.

**CAUTION**

We advise regularly checking the charge status (visual check of pressure gauge and weight) and also its overhauling, according to the rules in force in the country whose flag the yacht flies.

**DANGER**

Pay particular attention during the cleaning and cooling operation because the components are still hot and can generate burns or scalds.

The arrangement of the fire extinguishers is indicated in the previous “Location of safety and fire-fighting equipment” diagram.

**CAUTION**

All fire extinguishers should be checked at least every 6 months by qualified staff and in any case, after each navigation. Even after a partial use, the extinguishers should be recharged by authorized personnel.

The extinguisher should be kept in a good condition and the charge indicator, located on the pressure gauge, must always be positioned in the green field.

Keep the extinguishers in a vertical position.

After the use of a dry-chemical fire extinguisher, carefully clean the parts that came in contact with the powder because it is highly corrosive.

2.8.3 Portable fire-extinguishers maintenance

Component	Maintenance	Notes and precautions
Portable fire extinguishers	Checks and tests	<p>Check the state of charge of each fire extinguisher at least once every 12 months, and in any case before each journey at sea, by means of the installed pressure gauge. The fire extinguisher is correctly charged when the weight value is as stated on the fire extinguisher's tag, and the charge indicator on the pressure gauge is in the green area.</p> <p>If they are found to be discharged or insufficiently charged, or at least every 10 years, have qualified technicians:</p> <ul style="list-style-type: none"> <li>• Check the condition of the container (cylinder);</li> <li>• Refill the extinguishing medium;</li> <li>• Carry out a hydrostatic test.</li> </ul> <p>Have fire extinguishers recharged even after partial use.</p> <div style="border: 2px solid black; padding: 5px; margin-top: 10px;"> <p style="text-align: center;"><b>MAINTENANCE</b></p> <p>At least every 12 months, and, in any case, before each journey to sea, check the state of charge of the fire extinguisher.</p> <p>At least every 10 years, and in any case before each journey to sea, check the external state of the fire extinguisher.</p> <p>At least every 6 months check the fastening of the fire extinguisher.</p> </div>

## 2.8.4 Life buoy

The life buoy is classified and resistant to sea water, to hydrocarbons, and to low temperatures; it is orange in order to be easily seen in water.

The life buoy is equipped with a lifeline of 30 m (98,4 ft) and with an automatic light buoy.

The life line is not twistable and it is orange in order to be easily seen in water.

### NOTE

Before navigation, move the life buoy from the sundeck and position it in a easily accessible place.

All passengers must know the stowing place of life buoy.

The Captain must make sure that all passengers know how to use the life buoy:

- How and where to throw it;
- How to give assistance in case of man overboard.



### 2.8.5 Individual life jacket

The life jacket is an individual safety device, consisting of a single chamber inflatable jacket, yellow-coloured to be easily visible in water and resistant to the effects of sea water, hydrocarbons and low temperatures.

This type of life jacket preserves the safety and float-ability requirements required by EU regulations.

These life jackets must be worn correctly and be firmly tied by means of strong laces. The individual life jacket is contained in a buoy bag container and is equipped with a whistle, fastened to the jacket by means of a safety cord.

The whistle is particularly useful to indicate the wearer's position when weather conditions do not allow sufficient visibility (bad weather, fog, etc..).

It is important to learn, particularly for children, how to float in water with the life jacket.

To avoid energy waste it is necessary to float by keeping legs and arms folded as far as possible and tight to the body to maintain the heat.

The individual life jacket has to be worn under following circumstances:

- When you navigate through sandbanks or tide reefs;
- At first sign of bad weather;
- When visibility is limited;
- When you navigate with rough sea;
- When you navigate alone;
- At any time with children below 10 years of age.

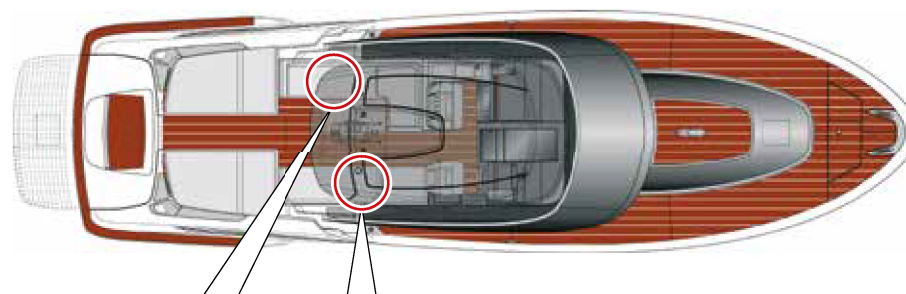

**NOTE**

The yacht must be equipped with a number of individual life jackets equal to the number of persons present on board. All persons boarded must know the location of the life jackets, how to wear them, how to tie them properly to the body, and where the whistle is located. We recommend reading the manual provided by the Manufacturer for correctly preparing and using the life jacket.

**DANGER**

If you are to choose a life jacket for a child, take care about for the correct size and that smaller children do not slip out of them once in water. We recommend that all children wear an individual life jacket when they move on the yacht.

### 2.8.6 Signalling rockets

Pleasure yacht are obligated to carry 4 manual rockets with red light and 4 manual orange smoke signals as required.

Always verify the legislation of the Country in whose waters the yacht is going to navigate.

- The signalling rockets have a validity in time; it is therefore necessary to check their expiry date and eventually to replace them.
- The floating smoke signals, visible up to 4 km (2,5 mi), have to be used with the daylight, to indicate the correct position.
- The red light rockets, visible up to 10 km (6,2 mi), are designed for night use, but they can also be seen during the day.
- Before using the signalling rockets, always wait for the arrival of an airplane or to see persons on the shore or on other yachts.
- Store the signalling rockets away from flammable liquids and from other fuels.

- As the content of the signalling rockets absorbs the moisture, make sure to have them located in a dry and accessible place.
- All persons boarded must know the place of the signalling rockets and the method of use.
- Carefully follow the activation instruction for all signalling rockets.

**DANGER**

Keep the signalling rockets away from heat sources, as flammable liquids or naked flames, and out of the reach of children.

**DANGER**

Once the signalling rocket has been lit, never direct it towards persons, there is a risk of burns and scalds.

**NOTE**

The signalling rockets have a validity in time, indicated on their containers. Once expired, contact the rockets suppliers which offer a disposal service. Do not light them unless necessary because they can activate the Emergency Services.

## 2.9 FIRE-FIGHTING SYSTEM

RIVA has made every effort, both as regards design and construction, to minimize the risk of on-board fires.

In particular, special attention has been paid to the choice of the materials used and to the accuracy of the construction and of installations.

The prevention of on-board fires, however, requires periodic maintenance of on-board systems and, above all, proper behaviour of on-board personnel.

In most cases, on-board fires are caused by sloppy maintenance, failure to carry out checks or poor sensitivity towards the need to try and remove any direct or indirect potential cause of on-board fires.

The possibility of successfully fighting a fire derives from the capability of preventing it, so as to avoid the conditions that help its outbreak, and from the promptness of the fire-fighting action.

Once the fire has been extinguished, it is important to identify the cause that triggered it (if this has not already been done previously) and, if possible, to eliminate it, or at least to take proper corrective actions.

Fire-fighting protection of the yacht is made up as follows:

- Fixed HFC227 gas fire-fighting system (for protecting the engine room);
- High temperature sensors in engine room and technical room;
- Portable dry-chemical extinguishers;
- Safety plates.

### NOTE

The equipment described above must only be used for its envisaged purpose. No other use is allowed under current rules.



### DANGER

Do not store flammable materials such as gas cylinders, fuel containers, spray cans, etc.. in the engine room or near heat sources. These objects must be stored in ventilated rooms and, if possible, on the outside.

### 2.9.1 Automatic engine room fire-fighting system

The yacht is equipped with one fix fire fighting system for protecting the engine room independent and complying with regulations' provisions.

The fire fighting system is composed of an automatics HFC227 extinguisher, located inside the room. The HFC227 fire fighting system installed on board has been designed to complete the discharge in a few seconds from the activation. In this way it is possible to reduce the time in which the fire can develop and expand, thus causing damages.

Delivered, the HFC227 reaches all areas of the protected room (engine room), does not damage the most delicate equipment and does not leave residuals.

It allows avoiding also the costs inherent to cleaning and operation restoration, therefore it allows resuming immediately the activities on-board.

The discharge is automatically activated by means of a sprinkler, installed on the bottle and filled with liquid that, when the room's temperature increases, expands and breaks the sprinkler itself, causing system activation.



## DANGER

The extinguisher cylinders are provided with a safety pin. Make sure that such pin has effectively removed. Otherwise, in case of a fire, the extinguisher will be locked, preventing activation of the discharge, with subsequent serious damages to the yacht, and even her sinking.

The automatic fire extinguishing system HFC227 is managed by an electronic control unit (SHUT DOWN). In case of fire in the engine room, the time when the discharge the extinguisher is activated, the control unit stops the propulsion engine, the generator and the engine room extractors; take anyway on the bridge and put the keys of the engines ignition in OFF.



## DANGER

The automatic fire fighting system that protects the engine room and the system room may not start under particular fire conditions and, therefore, IT IS ALWAYS COMPULSORY TO MANUALLY OPERATE THE FIRE FIGHTING CONTROL TIE RODS (see procedure shown hereinafter).



## CAUTION

If a fire is detected, it is necessary to manually operate the system, without waiting for the automatic activation, in order to minimise the damage.

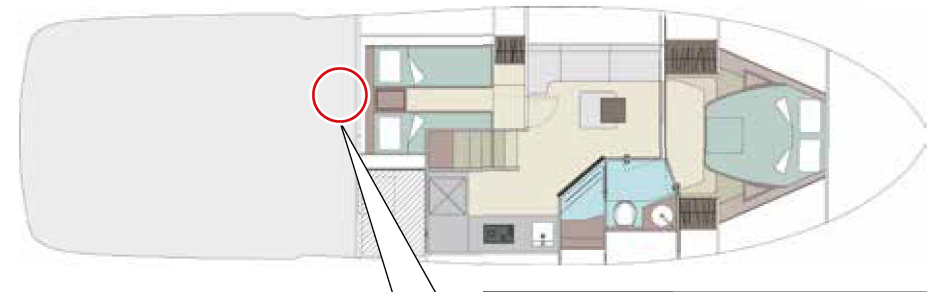

On the main deck there is the panel (1) that indicates the state of charge of the engine room fire extinguishers.

In addition, there is the control panel, equipped with optical and acoustic alarm, manages and monitors the sprinkler system of the engine room:

- **GREEN light**  
Indicates that the fire extinguisher is charged.
- **RED light**  
Indicates that the fire extinguishers is not charged.
- **SILENCE button**  
It turns OFF the acoustic signal which indicates that the system is operating and that the extinguisher is releasing gas.
- **DIMMER**  
It varies the brightness of the control lights of the CHARGE/ OVERRIDE panel.
- **OVERRIDE button**
  - When this button is pressed, the control unit which, in case of extinguisher discharge, stops the engines, generators and extractors, is cut OFF.
  - In **OVERRIDE** position the control unit is disabled.

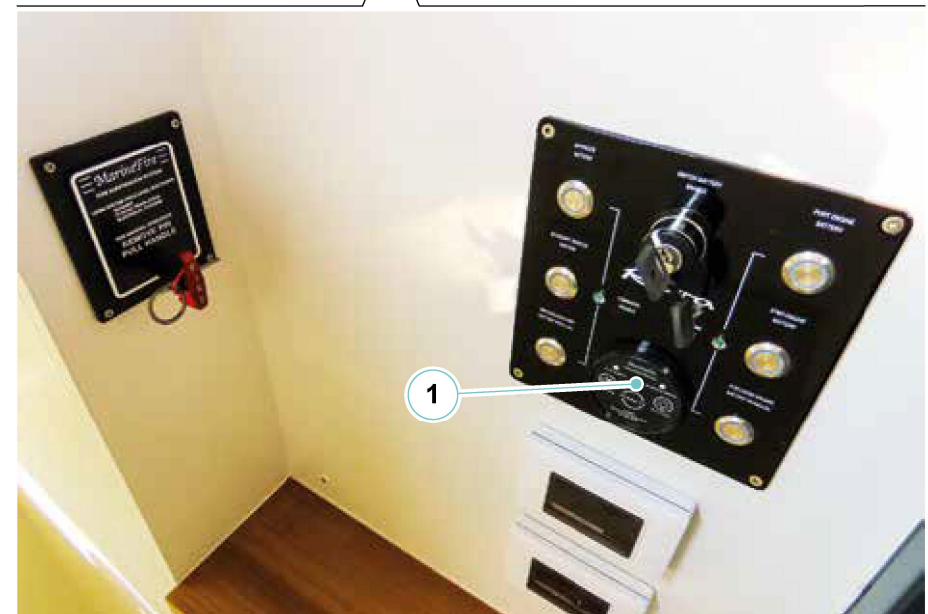
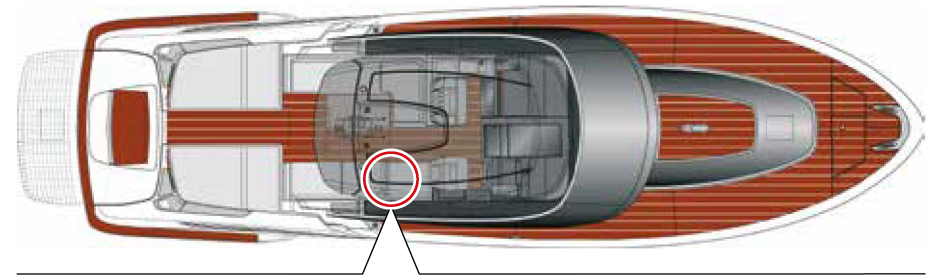

## DANGER

In case of fire, use the "OVERRIDE" to restart the engines, only in case of collision risk or during navigation in narrow waters.



## CAUTION

The "OVERRIDE" button must only be used in case of a real emergency.

## Automatic engine room fire-fighting system diagram

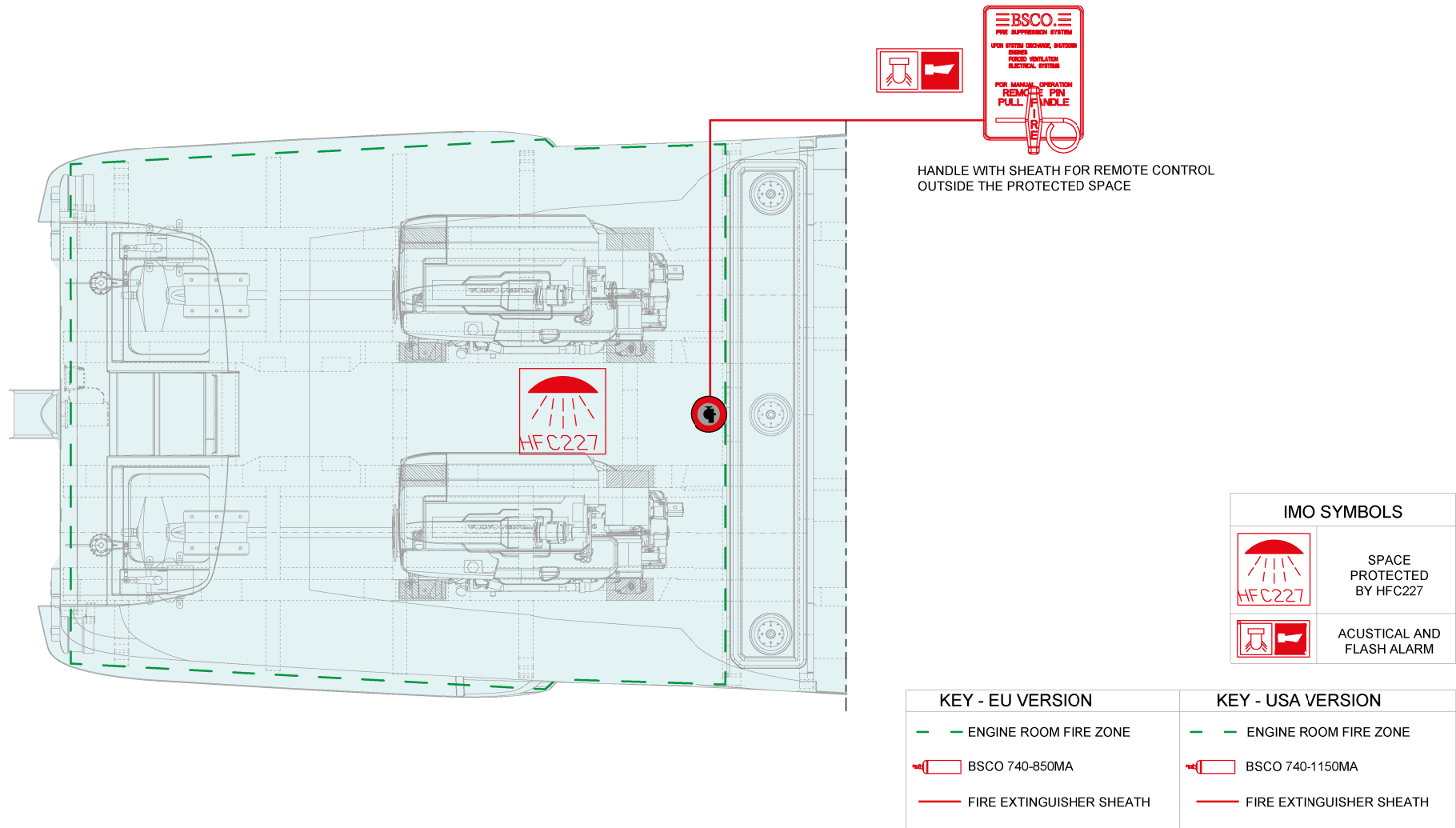

## 2.9.2 Manual fire-fighting system

The automatic fire fighting system may not start under particular fire conditions; therefore, it is necessary to operate the safety tie rods (1) in order to manually activate the fire fighting systems.

Starboard, next to the crew cabin entrance (optional), there is the manual fire-fighting system tie rod of engine room.

Operating the handle of the tie rod of the room involved in the fire, by means of a sheathed steel cable, it is possible to activate the relevant bottle's discharge, if the discharge has not yet been activated automatically, and simultaneously the system shut down the:

- Shut down the engines;
- Shut down the air extractors;
- Shut down the electrical system.



### DANGER

Each fire extinguishing tie rod is provided with a safety pin, that must always be inserted in order to avoid accidental discharges of the HFC227 fire extinguisher.

The safety pin, when inserted, prevents discharge activation by means of the tie rod. The safety pin must be removed only when you intend to operate the extinguisher discharge tie rod.

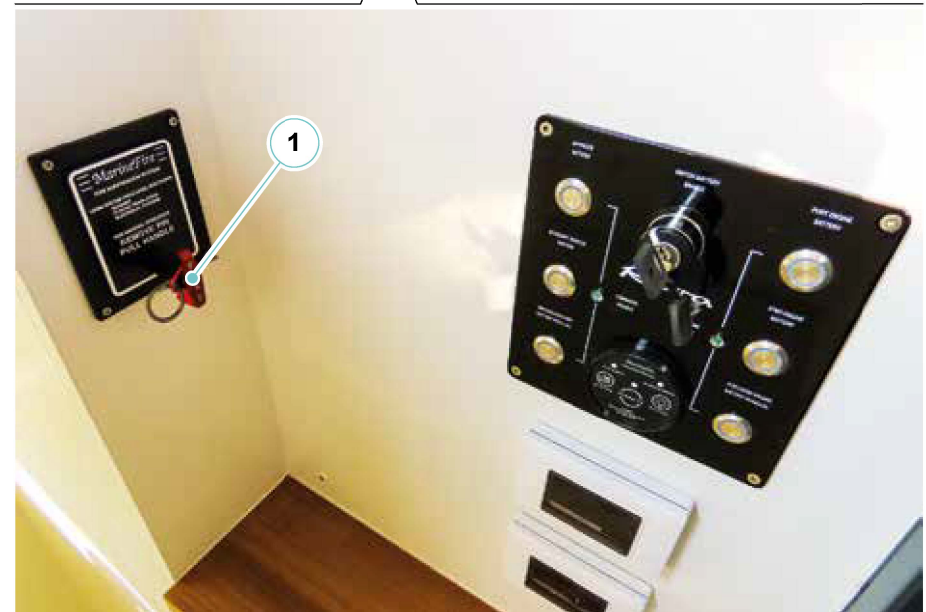
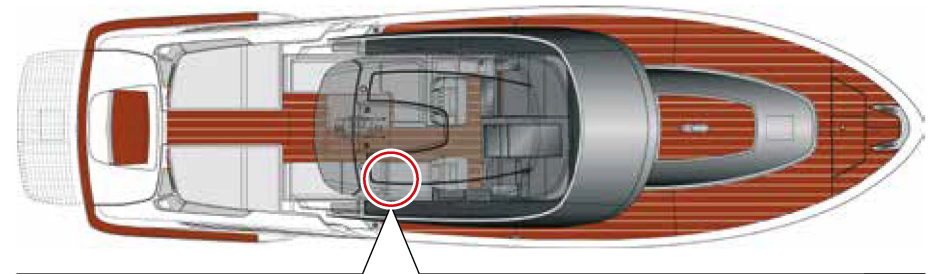

In case of fire in the engine room, carry out the following operations as soon as possible:

- Stopping the propulsion engines through the special engines keys, turn OFF the generator and engine room extractors acting directly on the electrical panel;
- Disconnect the battery breakers and all AC input magneto-thermal switches, in order to avoid feeding fires and short-circuits.
- Reach the fire fighting control tie rod.
- After having removed the tie rod's safety pin, operate the handle pulling it towards yourself, in order to:
  - Close the main engines and generator fuel supply circuits;
  - Activate the engine room HFC227 extinguisher discharge.
- The system may have already been activated by the automatic system, however it is advisable to operate the tie rods in any case.
- If the fire breaks out while the yacht is underway, carry out the "MAY DAY" distress call; if the fire breaks out while moored in the harbour, alert the Harbour Authorities and the surrounding yachts, and evacuate all non-necessary personnel.



**DANGER**

Before activating the engine room fire fighting system make sure that no people is inside the room.

Do not open the engine room or utility room access hatch until you are absolutely sure that the fire has been extinguished.

After the discharge, wait for a sufficient lapse of time and verify that the fire is out. Ventilate the room before entering it for inspecting it thoroughly.



**DANGER**

Keep the fire-fighting control rod system efficient by having the periodic maintenance and functional checks carried out by skilled personnel.



**DANGER**

Pay the utmost attention when touching equipment. It may still be very hot and can cause burns.

**NOTE**

In case of fire, ALWAYS turn the engine keys to OFF.

### 2.9.3 Essential restoring for resuming navigation

If the fire-fighting system of the engine room has been activated and a fire has been extinguished, it is necessary to restore the essential conditions for navigation, in order to autonomously reach the nearest harbour in which to carry out the due checks.

To resume navigation, the ventilation system of the engine room and the fuel system of the propulsion engines must be brought back to normal working condition.

In order to allow starting the propulsion engines and the generator and re-starting the air extractors, set the fire fighting control panel switch to OVER-RIDE.



#### **DANGER**

Restoring the fire-fighting system with the aim of resuming navigation is an advisable operation only when the fire has not caused damage to the structure or to critical systems of the yacht.

In such a case, or should you have any doubt, it is essential to wait for rescue without resuming navigation.



#### **DANGER**

The operations for restoring the fire fighting system must be carried out directly from the engine room; therefore, before carrying out any operation, carefully read the safety instructions reported in the this manual.

#### **NOTE**

Remember that, following the restoration of the fire-fighting system, the fire extinguisher is discharged and it shall not be operational in case of a new fire.

Therefore, once returned to the harbour, you must have the fire extinguisher immediately recharged by authorized personnel.

### 2.9.4 CO<sub>2</sub> and high temperature sensors in the engine room

The gas (CO<sub>2</sub>) and high-temperature detection system is an essential surveillance component for preventing any fires that may occur during operation. Such system consists of 3 detectors situated in engine room (1), 1 detector in the cabins (2) and in the bow thruster.

In case of CO<sub>2</sub> concentration or high temperature in the engine room (above 57°C [134,6°F]) the temperature detectors activate the alarm siren located on the helm position dashboard.

Together with the siren, the alarm lights illuminate on the main electrical panel and on the helm position synoptic panel.

The temperature detection system is directly connected to the batteries, allowing its operation also while the yacht is left unattended and when the battery breakers are OFF.

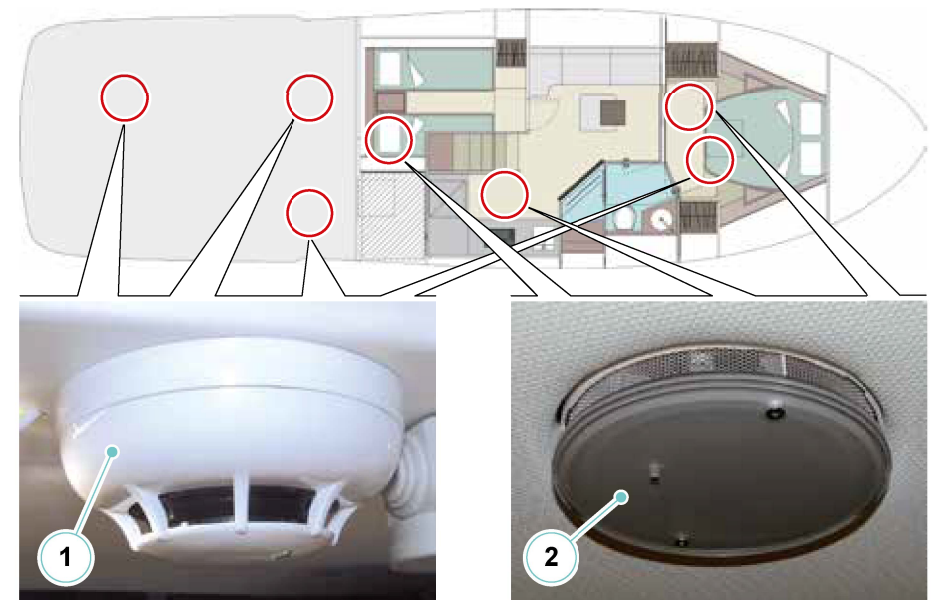

2.9.5 Maintenance of the fire-fighting system

Component	Operation	Notes and warnings
HFC227 gas fire extinguisher	Checks and tests	<p>Check the charge status by means of the pressure gauge installed on the cylinder. The charge status can also be checked also by measuring the cylinder weight.</p> <p>The extinguisher is properly charged when the pressure and weight values comply with the specification reported on the extinguisher tag.</p> <p>Before installing, weigh the extinguisher (bracket excluded) and record the date and weight on the special tag.</p> <p>Check the weight (bracket excluded) every six months: if the weight has decreased with respect to the previous checks, recharge or replace the extinguisher.</p> <p>Have the preservation status of the container (cylinder) checked by qualified technicians at least at the beginning of each season.</p>



**DANGER**

Accidental discharge of the fire extinguisher during handling or installation may cause serious injury. Insert the safety pin on the valve again until the installation or the check has been completed.  
Protect your eyes during maintenance and installation operations.



**DANGER**

Once maintenance and installation have been completed, remove the safety pin from the extinguisher valve.



**DANGER**

During maintenance operations, pay attention not to unintentionally break the flask, because, even if the safety pin is inserted, if the flask breaks, the fire-fighting system activates.



**DANGER**

Before entering the engine room, it is necessary to ventilate the rooms properly, so as to avoid risks of burns and poisoning, due to high temperatures and to noxious gases suspended in the air.

Fire detection system diagram

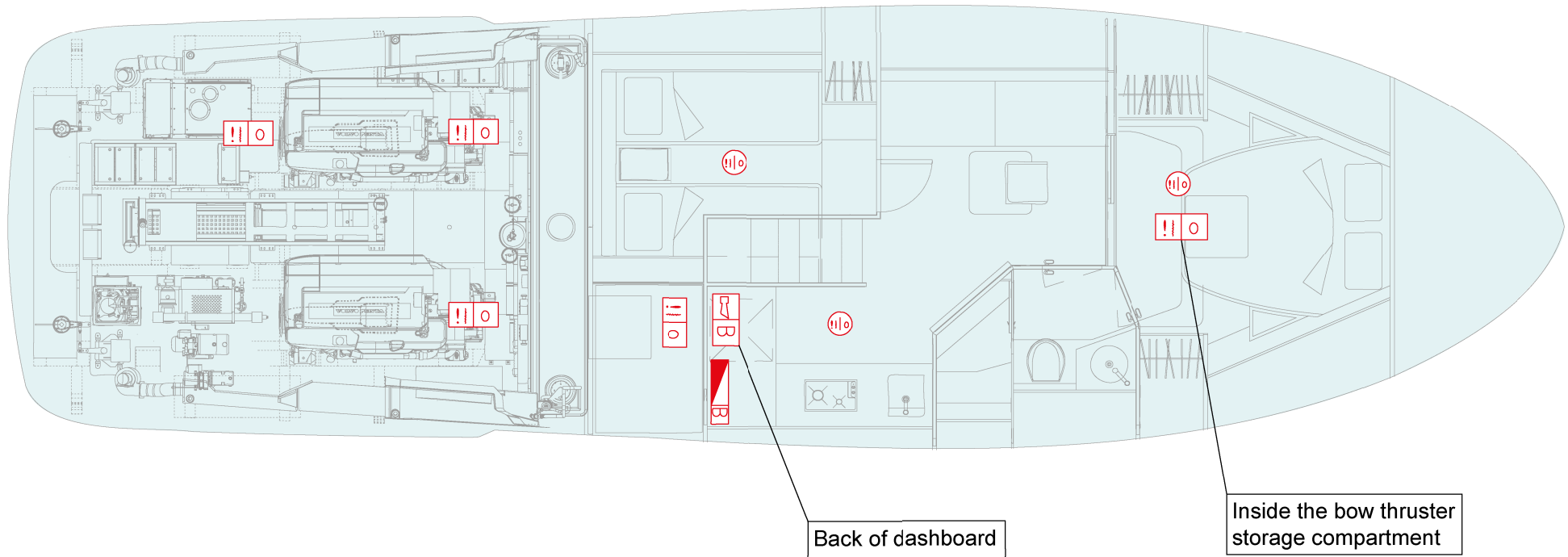

Fire detection control unit



Smoke sensor



Buzzer fire detection



Optical glass smoke sensor with ring nut

## 2.10 MANDATORY SAFETY EQUIPMENT

In order to ensure the maintenance of the intrinsic safety conditions of the yacht, the Owner must keep the yacht in good operational conditions (as regards to the hull, and the propulsion, electrical and fire-fighting systems), and also to provide for the replacement of any system, rescue and safety equipment showing signs of wear or deficiencies capable of impairing their efficiency.

In addition to the equipment provided by RIVA, the Owner is responsible for providing the yacht with any further system and safety/marine equipment required by the rules in force in the nation where the yacht is used, according to weather and sea conditions and to the distance from safe harbours along the intended course.



### **DANGER**

Rescue equipment must be arranged so as that when it is launched there are no obstacles to free floating and must be equipped with proper fitting allowing for quick release from the yacht when at sea.

The Owner is responsible for equipping the yacht with some of the equipment listed.

### **NOTE**

Refer to the local Port Authorities for instructions and changes of the Safety Rules in force in the country where you are.

### 2.10.1 First aid kit

The first aid box must be kept on board of class “A” yachts qualified for navigation “with no limits from the coast”.

The container must be rigid, floating and with watertight closure.



#### ENVIRONMENT

This area describes the feared environmental risk.

This is the minimum quantity of the medicines recommended for the Owner to keep on board:

- 1 disinfectant bottle for outer use 250 cc;
- 1 dark glass bottle of ammonia;
- 5 packs of bandages of various sizes;
- 1 pack of plasters;
- 1 pack of medicated plasters;
- 1 250 g (0,55 lb) pack of cotton wool;
- 1 pair of scissors;
- 1 pack of compressed hydrophilic gauze of various sizes;
- 1 pack of compressed Vaseline gauze of various sizes;
- 1 tourniquet;
- 1 pack of splints for fractures.



#### DANGER

Remember to check the expiry date and the availability of the products contained in the first aid kit at regular intervals.

Remember to store those medicines, which need to be kept in cool places in the fridge.

Inform all passengers of this.

Keep the first aid box in a place free from moisture and away from heat sources, easily accessible, quickly reachable in case of need and far from the reach of children.

## 2.11 ITEMS USEFUL TO HAVE ON BOARD

In addition to the standard safety and marine equipment, we recommend keeping on board a number of items (not included in the standard equipment), that can be useful when operating the yacht; most probably, these items will not be used frequently, but may be determining for navigation safety and continuity in case of trouble.

### Standard equipment:

- 2 lines, Ø 18 mm (0,71 in), 10 m (32,8 ft) long;
- 2 lines, Ø 18 mm (0,71 in), 20 m (65,6 ft) long;
- 1 spare anchor 25 kg (55,1 lb) with line and chain;
- Yacht hook.

### Suggested equipment to be kept on board:

For mooring and towing operations:

- 2 lines, Ø 25/30 mm (1/1,2 in), 25/30 m (82/98,4 ft) long;
- 2 lines, Ø 20 mm (0,8 in), 20/30 m (65,6/98,4 ft) long;
- 1 line, Ø 30 mm (1,2 in), 50 m (164 ft) long;
- 1 line, 5 mm (0,2 in), 100 m (328 ft) long;
- 1 spare anchor 50 kg (110,2 lb).
- 

For the electric system:

- Complete set of lights for navigation lights;
- Spare for little spot lights;
- Spare for engine room lights;
- Fuses;
- Insulating tape.

For maintenance of on-board engine equipment:

- Funnels of various dimensions with rubber pipe;
- 30 kg (66,1 lb) of engine oil;
- 10 kg (22 lb) of gear box oil;
- 5 kg (11 lb) of hydraulic oil for the steering system;
- 2 kg (4,4 lb) of hydraulic oil for interceptor;
- 1 kg (2,2 lb) of hydraulic oil for thruster;
- Stainless steel pipe clamps of various dimensions;
- Working gloves;
- Rags;
- CRC spray;
- Vaseline spray;
- Propulsion engine spare part kit (suggested by the Manufacturer);
- Power generator spare parts kit (suggested by the Manufacturer).





*Riva*

DOLCERIVA

### 3 - DESCRIPTION OF THE YACHT

### 3.1 MAIN DIMENSIONS AND CHARACTERISTIC DATA OF THE YACHT

#### 3.1.1 Main dimensions



Overall length (ISO 8666) (Loa)	14,92 m	48 ft 11 in
Hull length (ISO 8666) (Lh)	14,76 m	48 ft 5 in
Waterline length (boat fully laden) (Lwl)	12,80 m	42 ft 0 in
Aft platform + anchor	0,16 m	0 ft 6 in
Minimum height for keel handling up to the Hard Top (H)	4,16 m	13 ft 8 in

Depth under propellers (boat fully laden)	1,48 m	4 ft 10 in
Maximum beam (included saddle tanks)	4,26 m	14 ft 0 in
Displacement unladen	21,4 ton	47179 lb
Displacement laden	24,5 ton	54013 lb

### 3.1.2 Data and features

- Hull type: warped hull with spray rails and aft deadrise 15,9°
- Construction material: fibreglass
- Engines: 2 x Volvo Penta D13-1000, 1000 mhp (735 kW) at 2400 rpm
- Gearbox: 2 x ZF 500-1 IV (r.r 1,964:1)
- Capacity of fuel tanks: 1800 litres (476 gals)
- Capacity of fresh water tanks: 310 litres (82 gals)
- Capacity of black water tanks: 120 litres (32 gals)
- Capacity of grey water tanks: 120 litres (32 gals)



#### CAUTION

RIVA yachts are designed to obtain a correct transversal trim with full optional equipment, as well as spare propellers and shafts. If the yacht is not provided with full optional and with spare propellers and shafts, some weights are inserted to correct the transversal trim. The above-mentioned weights can be removed or displaced as soon as the yacht is provided with a new equipment.



#### CAUTION

Any change in the disposition of the masses aboard may significantly affect the stability, trim and performance of the yacht.

#### NOTE

The technical specifications and the performances indicated are merely indicative, do not constitute an offer with the value of a contract in any way, and are referred to standard models of the yachts built by the Shipyard in the European version.

The only technical indications or descriptions with contract value for the purchaser are those relevant to the specific yacht purchased and contained in the sale documents.



#### CAUTION

- Bilge water should be kept to a minimum.
- Stability is reduced by any weight added on top.
- In the event of rough seas, doors, cabinets and doors must be closed to reduce the risk of flooding.
- Breaking waves are a serious stability hazard.

## 3.2 GENERAL DESCRIPTION

RIVA, a long-time a leader in the high-end yacht sector of the shipbuilding industry, puts great effort in the study and design of the general arrangement, pursuing the maximum functionality and comfort, while retaining the exclusive aesthetic features that characterise the yachts by RIVA.

The yacht is divided into the following zones:

- Main deck;
- Lower deck;
- Engine room.



### CAUTION

Access the Hard Top only with safety belt by qualified/trained technical personnel for work at height.

Main deck



Lower deck



Engine room

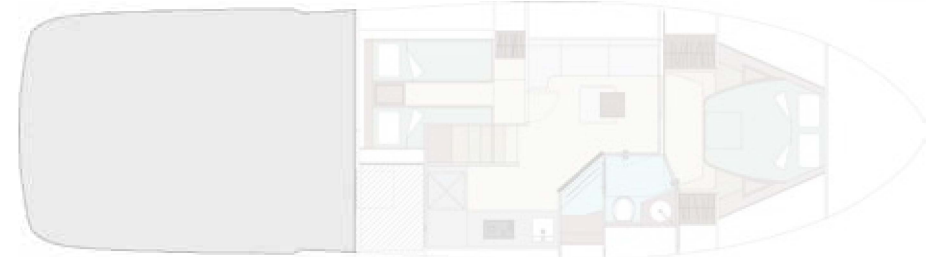

### 3.3 MAIN DECK

The main deck consists of a large external area on which you can enjoy the luxury and comfort of your yacht in the open air.

The sofas in the cockpit and stern sun-bathing area are large and comfortable and equipped with high-quality accessories.

Besides the areas studied to ensure maximum comfort to the owner and his guests, the main deck is provided with a set of services and systems useful for navigation and for the mooring and anchoring phases.

1. Black water shore discharge (WASTE)
2. Stern port peak
3. Shore socket peak
4. Fresh water inlet (WATER)
5. Stern sundeck
6. Cockpit table
7. Cockpit washbasin
8. Pilot seat
9. Helm position
10. Windshield
11. Port mooring cabinet
12. Master cabin skylight
13. Chain/anchor windlass/fender peak
14. Bow fairleads and cleats
15. Sliding door accessing the lower deck
16. Engine room access
17. Gangway
18. Cockpit sofa
19. Starboard peak
20. Crew cabin access (optional)
21. Fuel inlet (DIESEL)
22. Peak for shower + fresh water shore supply
23. Swim ladder

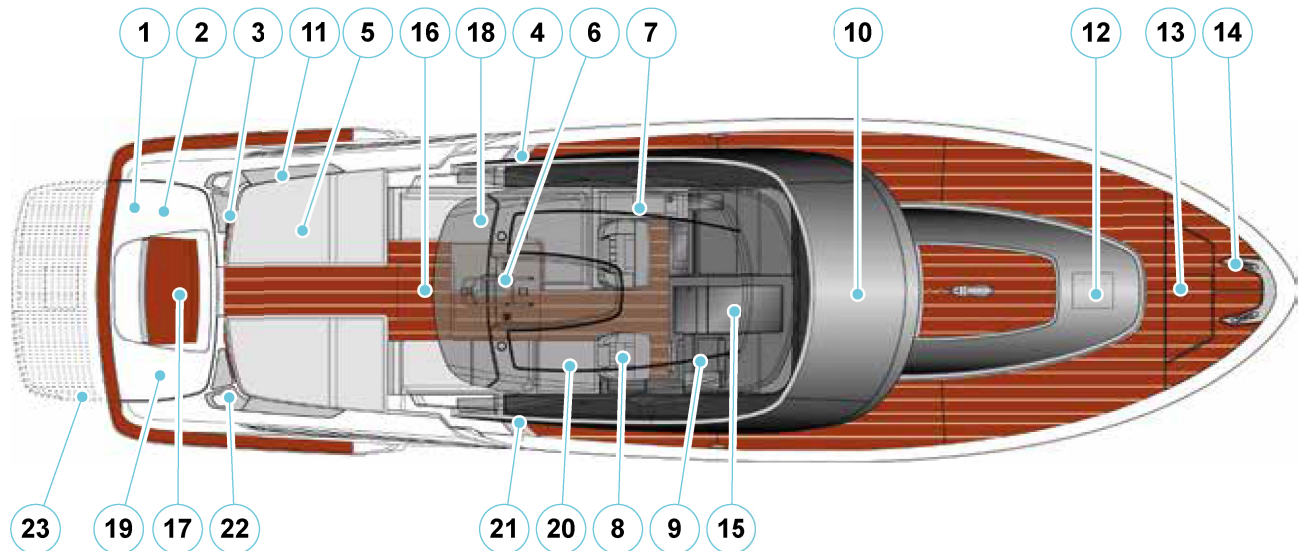

**3.3.1 Main deck access**

The hydraulic gangway (1) situated in the central side of the stern zone allows access to yacht from shore.



**CAUTION**

Always use the gangway to board the yacht; any other access system is potentially dangerous.

You can go back aboard your yacht from the sea using the swim ladder (2) situated in the stern platform.



**DANGER**

Never stay on the stern platform during navigation, because this is not equipped with protection rails preventing a possible fall at sea.



**DANGER**

Never start navigation with swim ladder and gangway a not correctly retracted or closed.

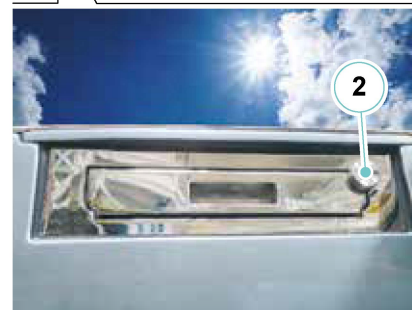

On the main deck there is a comfortable bench equipped with a practical table.

On both sides of the yacht inside the mooring lockers the aft cleats and the warping winches are stowed, useful for shore approaching manoeuvres.



## CAUTION

Do not use the warping winches as permanent mooring points.



The shore power supply socket is located in the stern zone, on the port side.



Aft of the port sundeck, is the boarding filler freshwater.



*Riva*

The shower and the fresh water inlet from shore is situated starboard the stern zone.



The swim ladder inside the seat in the stern platform is located.



**DOLCERIVA**

Inside port compartment in the stern zone the black water suction nozzle is located.



The refuelling plug aft of the starboard sundeck is located.



# Riva

The storage access door (optional), the fire tie rod, and the battery switch panel are situated starboard the cockpit.



## CAUTION

The removable awnings and their support poles must always be dismantled and stored in the appropriate places before starting navigation. When the poles are not in use, they should be stored in the appropriate places. The awnings should only be installed when the yacht is at a standstill and the weather conditions are favourable. Do not leave the awnings open in case of heavy rain. Not leave the awnings installed unattended. Do not let them stagnate the water on the curtain fabric. When not using the awnings keep the holes to engage the poles closed with the appropriate lids.

# DOLCERIVA

The cockpit area of the main deck contains a large area richly furnished for the social and convivial life of the Guests. One comfortable sofa extend on the entire width and a table with folding top is located. Fore of the cockpit there is the helm position, where all main yacht steering and control instruments are installed. From the cockpit zone, all main deck equipment can be managed, such as the fire-fighting controls.



# Riva

In the cockpit zone are also important safety equipment: underneath the starboard sofa is the life raft and the portable powder fire extinguisher is situated starboard the helm position.



In order to access the life raft storage peak under the cushions of the cockpit sofa, after removing the cushions, it is necessary to completely lift and extract the hatch.

# DOLCERIVA

The zone of the external washbasin is situated in the bow port side of the cockpit with a practical mini-bar underneath the seat and close to the washbasin is the cooler.



# Riva

All manoeuvres, operations, navigation control, telecommunications and yacht monitoring are carried out from the helm position (see chapter 4 “Helm position” in this manual).

The pilot's seat consists in a folding seat.



# DOLCERIVA

The companion is located between the helm position and the port utility cabinet, through which, by means of a comfortable staircase, it is possible to access the lower deck.



## **DANGER**

Only allow authorized and qualified personnel to use the devices installed in the helm position.

The personnel operating the yacht during the various activities

# Riva

The bow zone is accessed going along the two side ways. Along the two lateral walk-around, are located the mid-yacht cleats, important for the reinforcement of the mooring with rough sea.



# DOLCERIVA

At yacht's bow the anchoring system is located.

The anchor winch is positioned at mid yacht. At bow are also located the chocks and the side cleats.



Inside of the two lateral peaks the remote control for the anchor winch the solenoid valve controlling the anchor and chain washdown and a fresh and sea water tap are housed.

Furthermore, inside the starboard peak, there is a spare anchor.



**DANGER**

Pay particular attention to rotary pieces, keeping your feet, hands, clothing and hairs at due distance.

If you control the anchor winch from the main helm position make sure that nobody is near it and that your visual field is free.

### 3.3.2 Navigation lights and shapes signals

The navigation lights installed on the yacht comply with the international Regulations as regards the minimum visibility range, horizontal and vertical brightness and colour specifications.

In order to increase the safety of people on board, the manufacturer has provided the installation of a mast for visual day signals, in accordance with Directive 2013/53/EU. It is equipped with two rings to fix the daytime signals.

The rules relevant to the navigation lights must be observed from sunset to dawn and, during this period, no other lights must be visible except the lights that cannot be exchanged for those specified in this manual:

- Stern light: white light on the removable mast astern, visible from the stern (fixed uninterrupted light with 135° sector).
- White navigation light: white light located on the signal mast, visible from bow, port and starboard (fixed uninterrupted light with 225° sector).
- Red and green navigation light: red on port side and green on starboard side (fixed uninterrupted light with 112,5° sector), positioned on bow removable signal mast.
- Anchor riding light: white navigation light installed on the signal mast, visible from any direction (fixed uninterrupted light with 360° sector). Night navigation requires more precaution. All rules are applicable but apart from the right of course, it is advisable to slow down and to keep the proper distance from other yachts.

It is a good rule to remember that bright lights reduce visibility at night.

Navigation lights are not watertight since it is necessary to compensate air pressure variation caused by temperature changes.

Therefore, the navigation lights are provided with a ventilation system used to allow compensation and humidity escape. The ventilation system must not be clogged with grease, dirt or other materials.

The use of headlights during the various situations of use of the yacht during night navigation are illustrated below:

- Navigation: Masthead lights, side lights and stern lights ON.
- At anchor: Anchor lights ON.
- Drifting: Two red lights ON (no steering mast installed).
- Stranded: Anchor light and two red lights ON (no steering mast installed).



#### CAUTION

Solvents may damage the lens of the navigation lights.

The lights must exclusively be cleaned with fresh water not containing solvents or abrasive substances.

Remove the bulbs before the application of any paint.

#### NOTE

Before undertaking any navigation, the Captain should make sure that all navigation lights are operating correctly. Use the navigation lights in compliance with the regulations in force.

#### MAINTENANCE

At least once a week check the operation of the navigation lights.

At least once a week carry out accurate cleaning of glasses and headlights.

At least once every six months check the presence of corrosion in the connections of the navigation light cables.

At least once every six months, tighten the cable connections of the navigation lights.

#### NOTE

The combined use of shapes, sound signals and navigation lights increases the visibility of the yacht, reducing the risk of collisions.



**WARNING**

Navigation lights, shapes and sound signals. Where navigation lights, shapes and sound signals are installed, they must be in conformity with COLREG 1972 (II International Regulations for Preventing Collisions at Sea) or CEVNI (European Code for Inland Waterways). Regulations depending on the case.



**CAUTION**

The positioning of the navigation lights is optimised by adapting the regulatory requirements to the geometry of the yacht, providing lights where they are most easily visible.  
 Non-steering lights (N.U.C. = Not Under Control) and a bell are not included in the on-board equipment.  
 The fitting of lights and sound signals is subject to the approval of the Flag Administration where the yacht is registered.

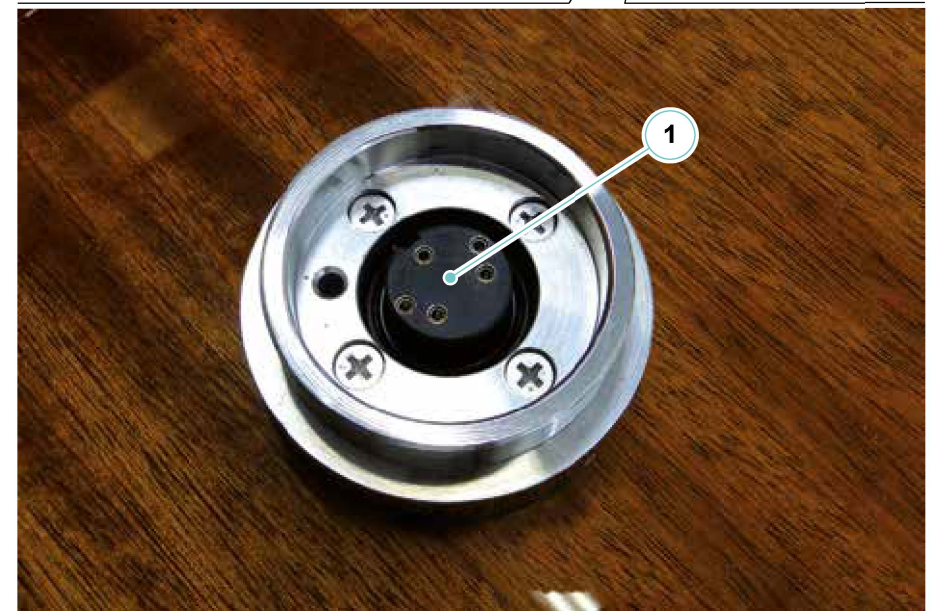
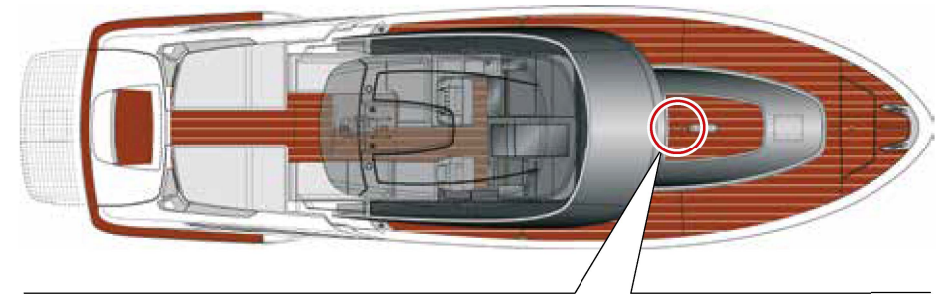

### 3.3.3 Mast for visual day signals

In order to increase the safety of people on board, the manufacturer has provided the installation of a mast for visual day signals, in accordance with Directive 2013/53/EU, in the appropriate seat (1).

Daytime signals have the same function as navigation lights but are more visible during the day than navigation lights.

Depending on the situation, appropriate signalling templates shall be used.

Hereunder is a list of the most common ones to adopt after installing the relevant mast:

- Yacht at anchor:

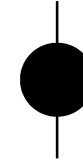

- Not under command yacht



- Stranded yacht:



- Yacht with limited manoeuvrability:



- Yacht to trailer or towed:



## Navigation lights and shapes signals diagram

N°	COMPONENT	COLOR	ELECTRICAL CHARACTERISTICS	VISIBILITY
1	Masthead light 225°	White	2,9W - 10-30 VDC	3 nm
2	Stdb side navigation light 112,5°	Green	1,4W - 10-30 VDC	2 nm
3	Port side navigation light 112,5°	Red	1,4W - 10-30 VDC	2 nm
4	Stern light 135°	White	1,1W - 10-30 VDC	2 nm
5	Anchor light 360°	White	1,8W - 10-30 VDC	2 nm

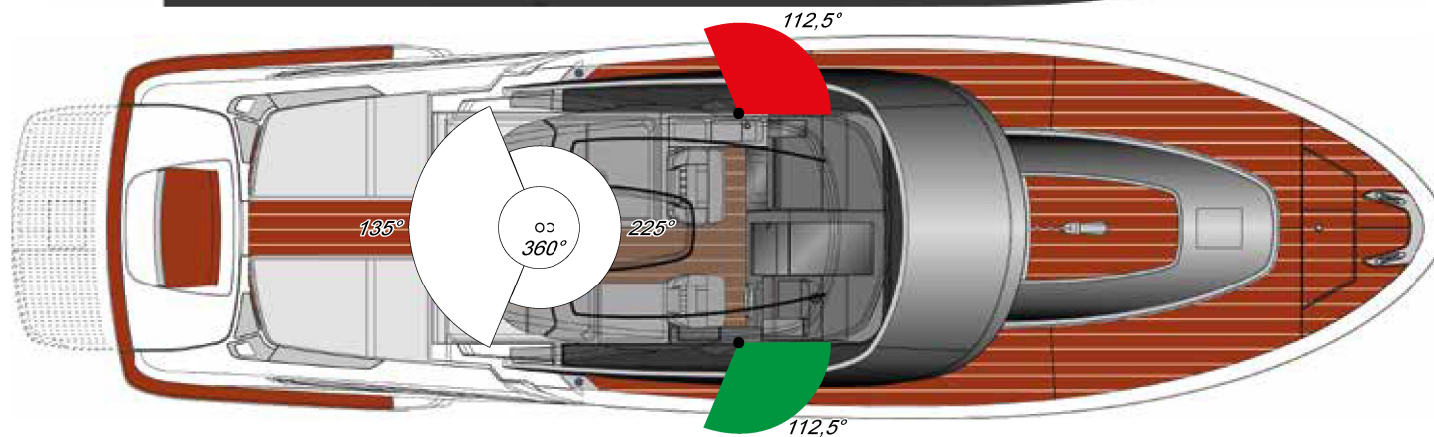
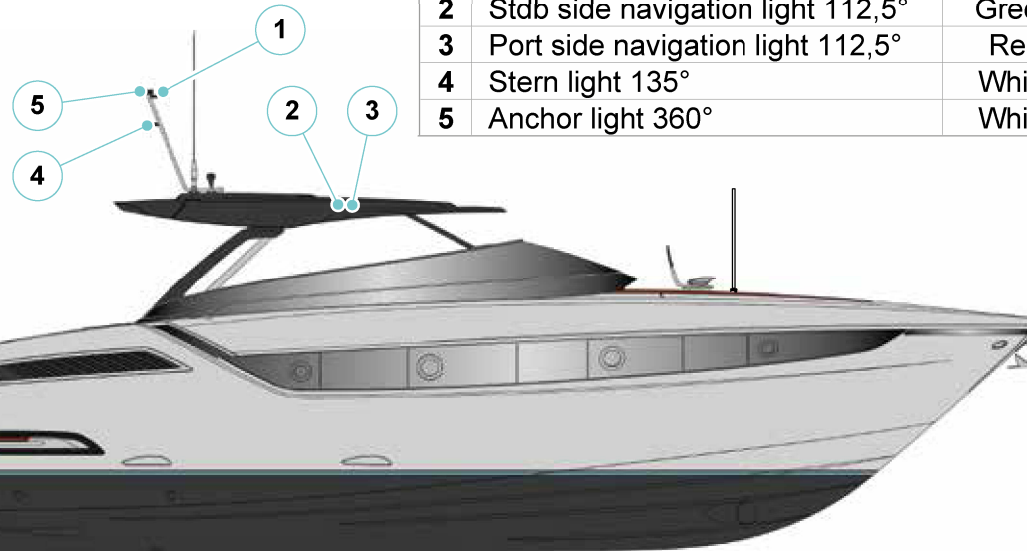

### 3.4 LOWER DECK

From the cockpit, through the companion and the staircase, it is possible to access the large saloon.

The galley, provided with high-quality household appliances, is located on the starboard side of the salon's central zone.

In the starboard bow zone is the bathroom.

In the central bow zone is the Owner's cabin.

1. Engine room
2. Saloon
3. Guests cabin
4. Cockpit access stair
5. Bathroom
6. Galley
7. Owner's cabin
8. Storage cabin

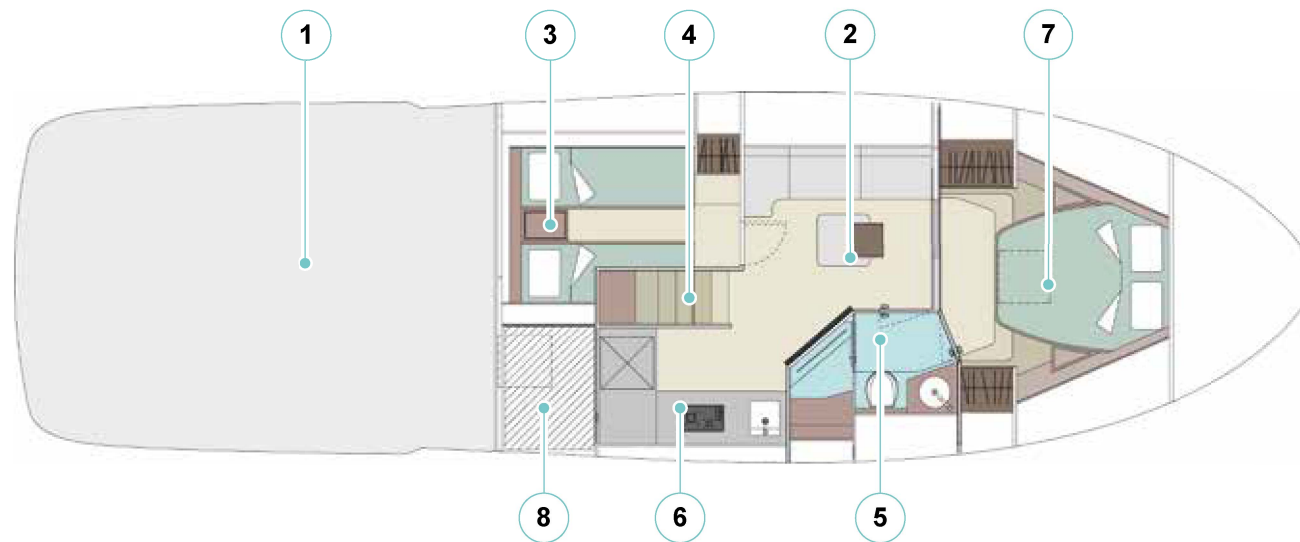

## 3.4.1 Lower deck access

Access to the lower deck is by staircase (1) that allow you to get in the salon (2).

From the salon, it is possible to access:

- To the owner's and guests cabin;
- To the service / owner bathroom.

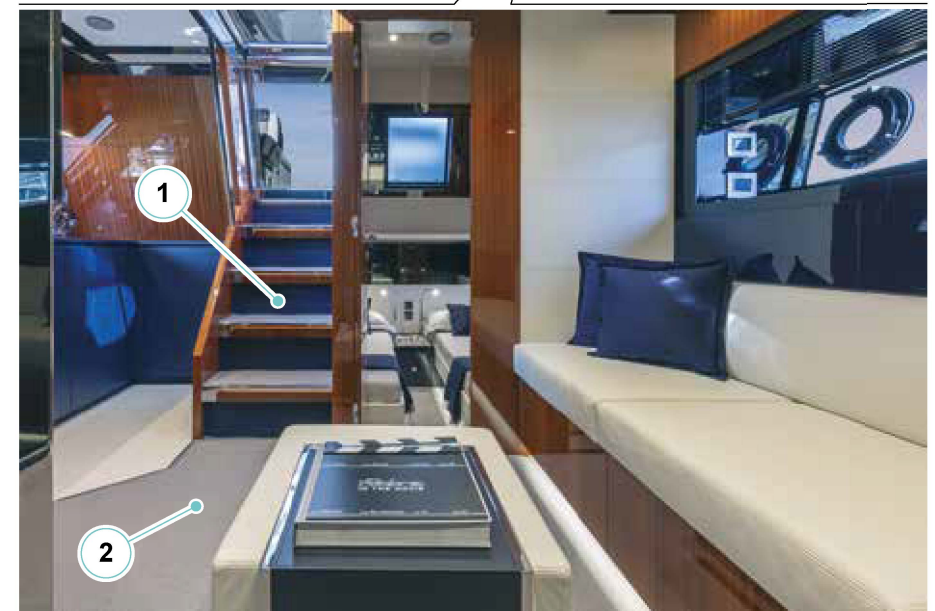
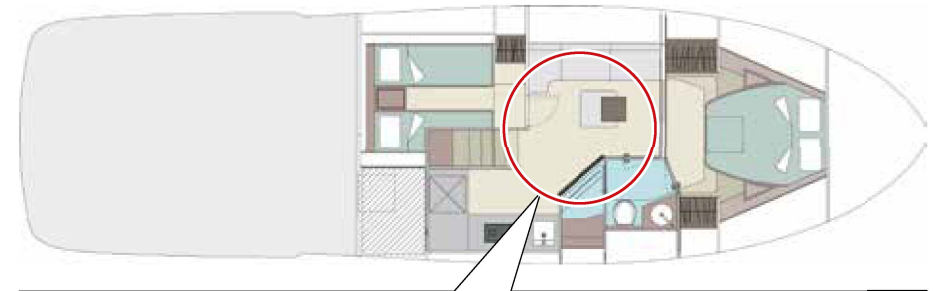

## 3.4.2 Galley

In the central area, on the starboard side, there is the galley, with the appropriate hob, the sink and the microwave oven.

The 230V cook top consists of two glass ceramic cooking plates. Above the cooker hob is the extractor hood for cooking fumes.



### **DANGER**

Do not touch the cook top whilst in use or when still hot.

### **NOTE**

Do not leave the pots unattended when they are on the cook top.  
Do not cook during navigation.

### **NOTE**

It is recommended not to fill pots more than 50% with water and not to use pressure cookers.

### **NOTE**

When using the galley, increase the ventilation of the inner rooms as much as possible.  
Never use the cooking top to heat the room.



**CAUTION**

Children are allowed to use the galley only when they are able to use its items correctly and to understand the dangers specified in the special instruction manuals. The help of an adult is required.

**NOTE**

In order to eliminate smells, steams or fumes, it is necessary to turn on the suction hood at cooking start and to keep it on after cooking end for 10-15 minutes.

**NOTE**

Please consider the fact that the cook top remains very hot for a certain period of time also after use and might cause damage to things or the risk of burns.

The microwave oven is located upper the sink and operates at 230V.

**CAUTION**

Never place metal containers or containers with metal inserts and liquid food in the oven.

**NOTE**

At least once a month check the proper functioning of the microwave oven. Perform a thorough cleaning after each use.

**NOTE**

Always check the absorption of the household appliances and deactivate them in case they are not used.

**NOTE**

In case of navigation with rough sea, we recommend not to use the galley.

**NOTE**

For the procedures and the correct use of the various household devices of the galley, refer to relevant manuals.

3.4.3 Owner's cabin

The Owner's cabin with bathroom entrance is situated at bow.

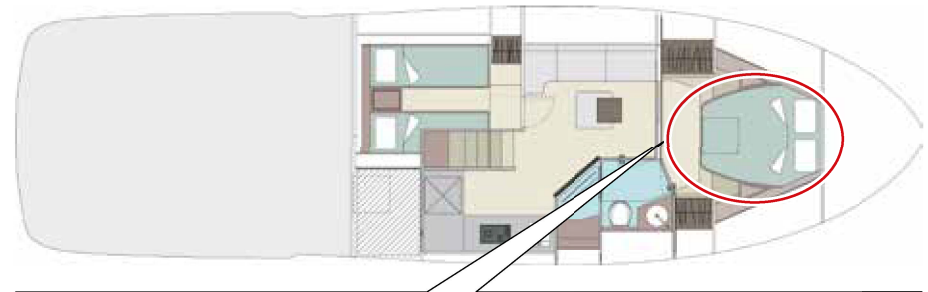

### 3.5 ENGINE ROOM

The engine room is accessible from the hatch located in the middle of the cockpit.

The hatch lifting is manual, using the handle.

The engine room has been arranged as tidily as possible with engines and pipes, by installing the auxiliary machinery as far as possible on resilient, to absorb vibrations.

The engine room is provided with a watertight bulkhead; all tube passages towards the bow, and vice versa, are installed on the watertight bulkhead.



#### DANGER

In the engine room, the high temperatures due to the operation of the engines create strongly radiated areas, in which temperature remains high for a long time. Protect yourself and wait until they are cool before entering the engine room.



#### DANGER

During navigation, accessing the engine room is not allowed.



#### CAUTION

Do not store free-to-move items in the engine room as they might skid during navigation.

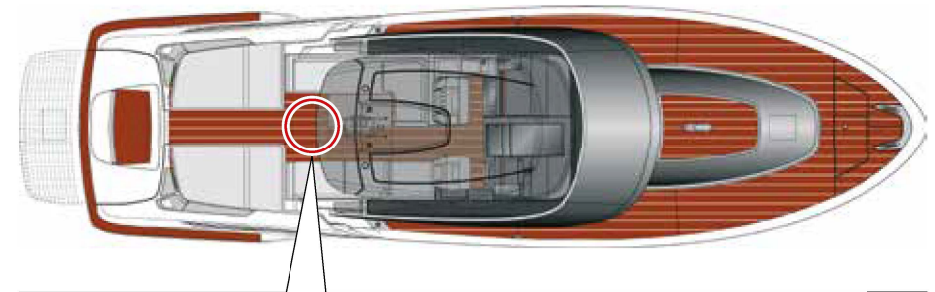

## Engine room diagram

1. Gyroscopic stabilizer
2. Generator battery
3. Generator battery switch box
4. Generator
5. Extractor
6. Interceptors
7. Steering system
8. Engine starter batteries
9. Utility battery fuse box
10. Gangway
11. Auxiliary utility battery fuse box
12. Air conditioning system
13. Bimini hydraulic unit
14. Watermaker (optional)
15. Multifunctional hydraulic unit
16. Separator
17. Fuel tank
18. Port Engine
19. Starboard engine

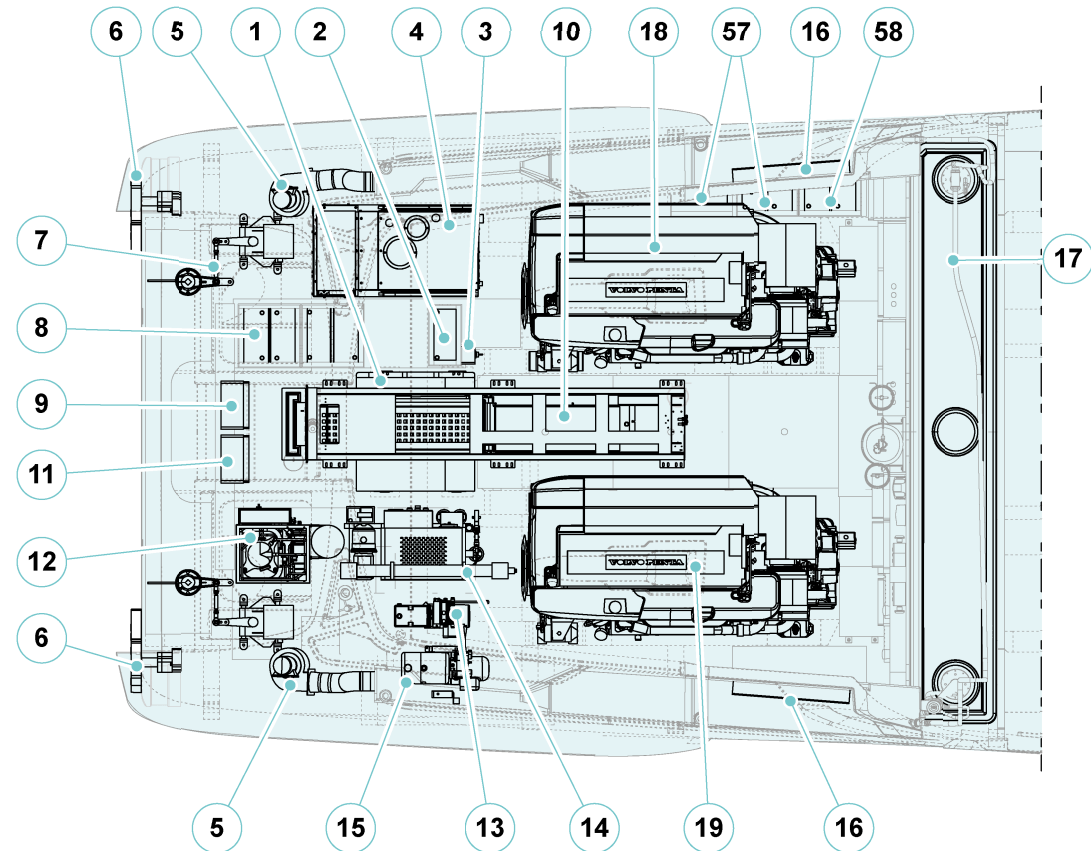

- 20. Port engine gas exhaust
- 21. Generator exhaust separator
- 22. Generator muffler
- 23. Generator fuel filter
- 24. Generator seawater intake
- 25. Gyroscopic stabilizer seawater intake
- 26. Generator battery chargers
- 27. Stern thruster
- 28. Bilge pump
- 29. Gyroscopic stabilizer seawater pump
- 30. Air conditioning seawater pump
- 31. Utility seawater intake
- 32. Pressure pump
- 33. Starboard engine gas exhaust
- 34. Starboard engine gas exhaust
- 35. Starboard engine seawater intake
- 36. Engine fuel filter
- 37. Port engine seawater intake
- 38. Starboard centralized exhaust
- 39. Air conditioning seawater intake (USA version)
- 40. Gyroscopic stabilizer seawater intake (USA version)
- 41. Sea water intake (USA version)

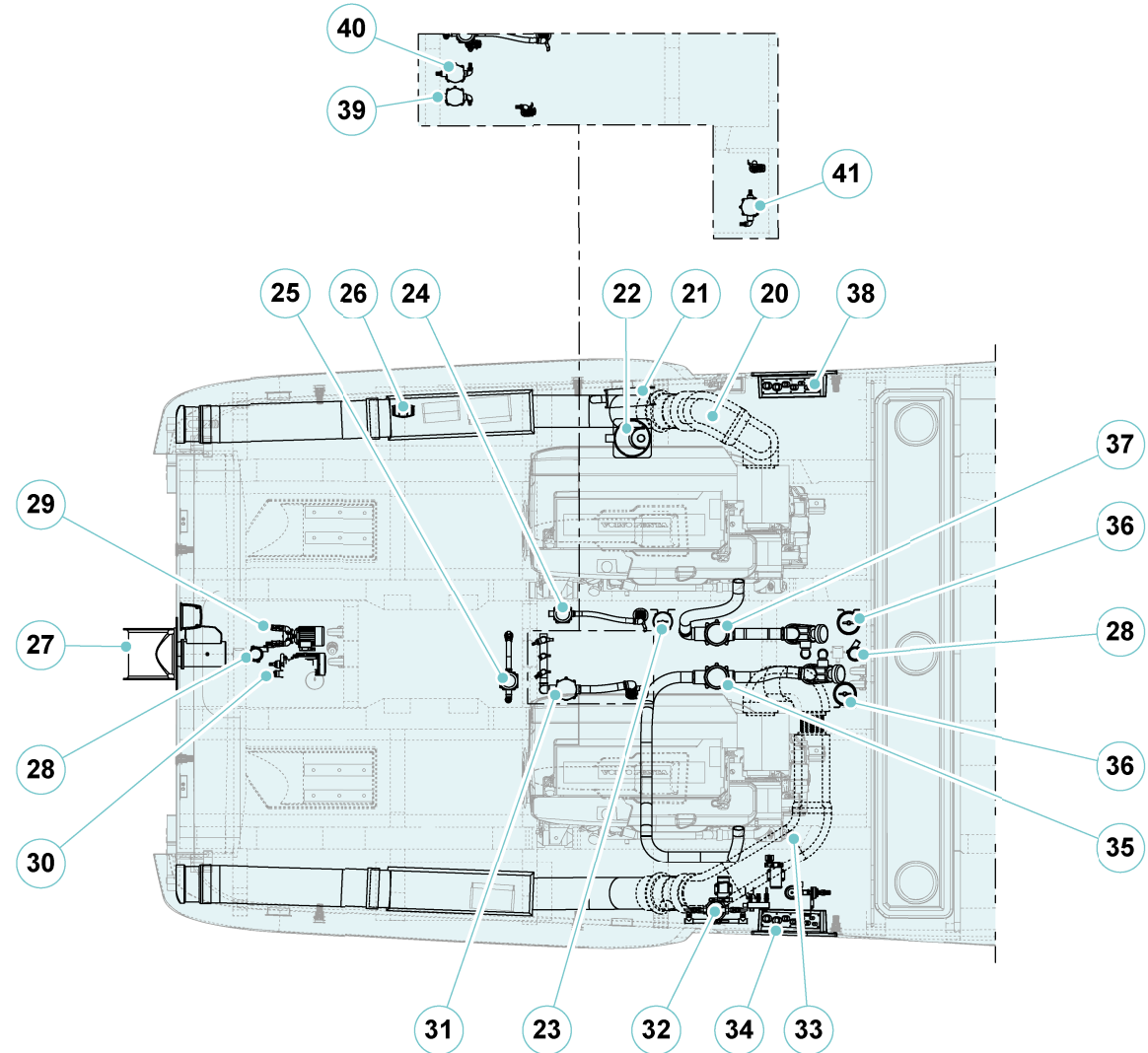

- 42. Fire-fighting cylinder
- 43. Battery switch box
- 44. 24V electrical panel
- 45. Negative boxes
- 46. Direct battery switch boxes
- 47. Engine fuel solenoid valve
- 48. Generator fuel solenoid valve
- 49. 230V electrical panel
- 50. Utility inverter
- 51. Utility battery charger
- 52. Stern thruster battery switch
- 53. Bow thruster battery switch
- 54. Engine battery charger
- 55. Gyroscopic stabilizer electronics supply
- 56. Fire-fighting cylinder (USA version)
- 57. Utility batteries
- 58. Auxiliary utility batteries

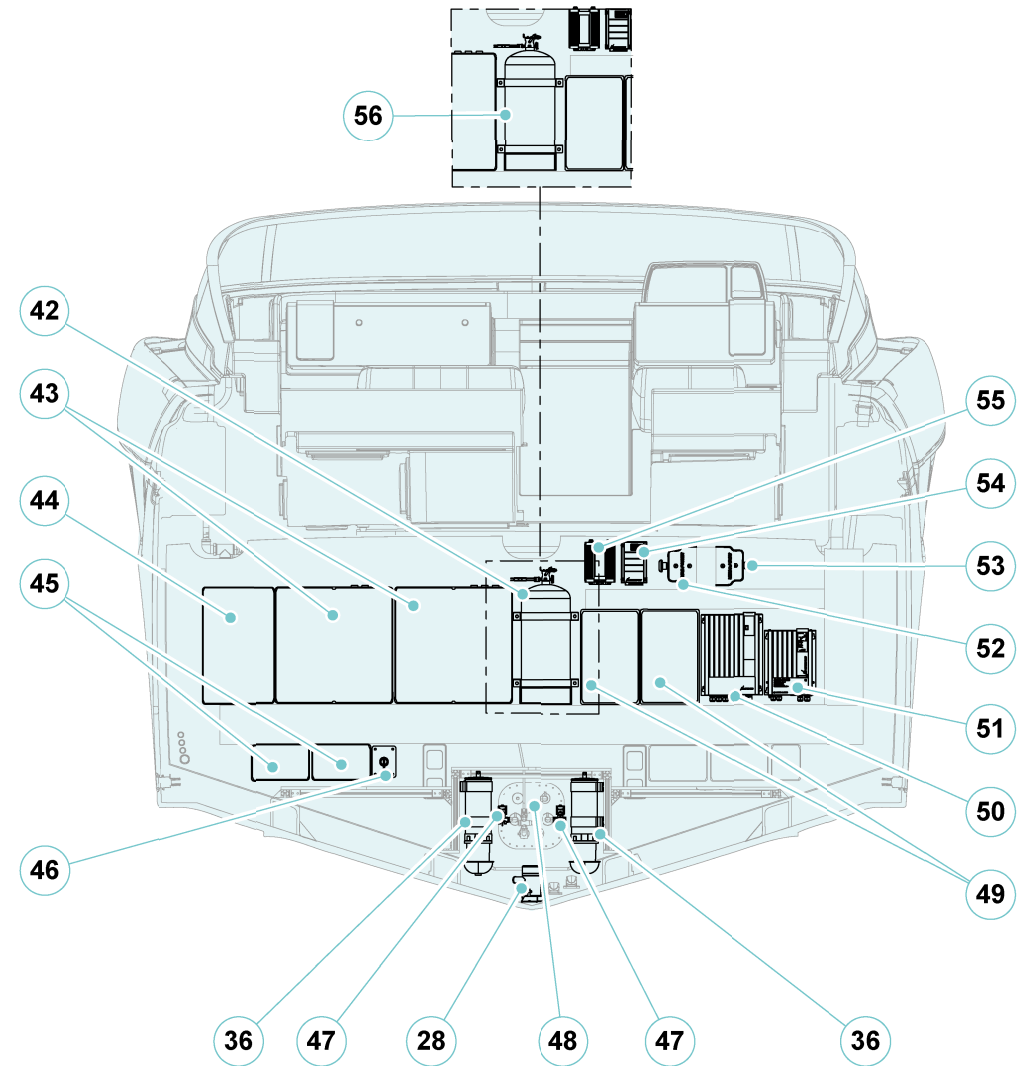





*Riva*

DOLCERIVA

4 - HELM POSITION

## 4.1 HELM POSITION

All manoeuvres, operations, navigation control, telecommunications and yacht monitoring are carried out from the helm position, with wide visibility and numerous instruments.

All devices prescribed by the various rules for safety at sea, fundamental for navigation, and the appliances required by the Owner are installed there. Each helm position component is supplied by a magneto-thermal switch located on the 24V utility main electrical panel.

### NOTE

This part of the Owner's manual contains the description of the components of the helm position. For further and in-depth information, please consult the specific manuals provided by the Manufacturers of the single appliances.



### CAUTION

It is a good rule to keep the instruments clean by washing them with wet and clean rags, avoid using chemical or abrasive products. After navigation, it is advisable to cover instrumentation and equipment.



### CAUTION

All electric appliances for navigation, whose parameters can be configured and set by software through the control panel, have been configured and tested upon delivery. These operations must be performed exclusively by authorized service personnel. Any modification of the preset configurations can alter the operation and reliability of the concerned system. Appliances must be used by the personnel in charge of driving the yacht and of using the systems.

The helm position can be divided into four sections described below:

- A. Top section
- B. Starboard top section
- C. Bottom section
- D. Starboard side section

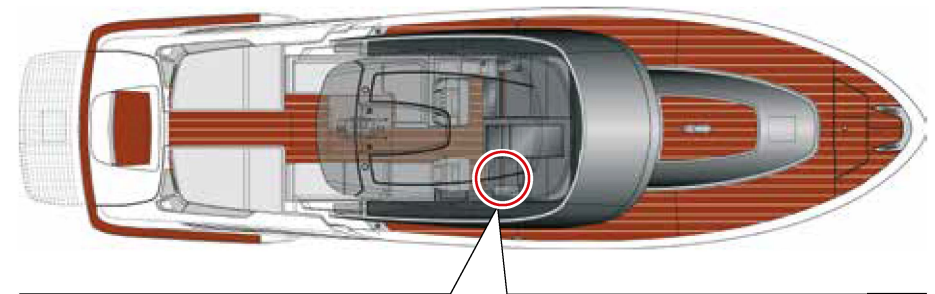

## 4.1.1 Top section

The top section of the helm position has the following utilities:

### 1. Multifunction display:

- Engines and engine exhaust alarms
- Radar
- Chartplotter
- Echosounder
- Navigation data
- Video

### 2. Rudder

It allows to control the yacht steering system.

Your yacht is equipped with a monitoring system, which performs the following functions:

- Control of bow (hull) and underwater (OPT, if installed) lights;
- Generator page with state and parameters visualization;
- Gyroscopic stabilizer page (OPT, if installed);
- Automatic trim control system with active ride function (OPT, if installed);
- Reading of port and starboard alternators recharging;
- Open/close state movements (hatch, gangway, swim ladder);
- Bilge alarms, (lh/rh) engine exhaust temperature, fire detection.

#### NOTE

For bilge and fire detection, the alarms are a repetition of the dedicated acoustic ones (with horn).

- Fan coil check page.

#### NOTE

The compressor group is not controlled by the system.



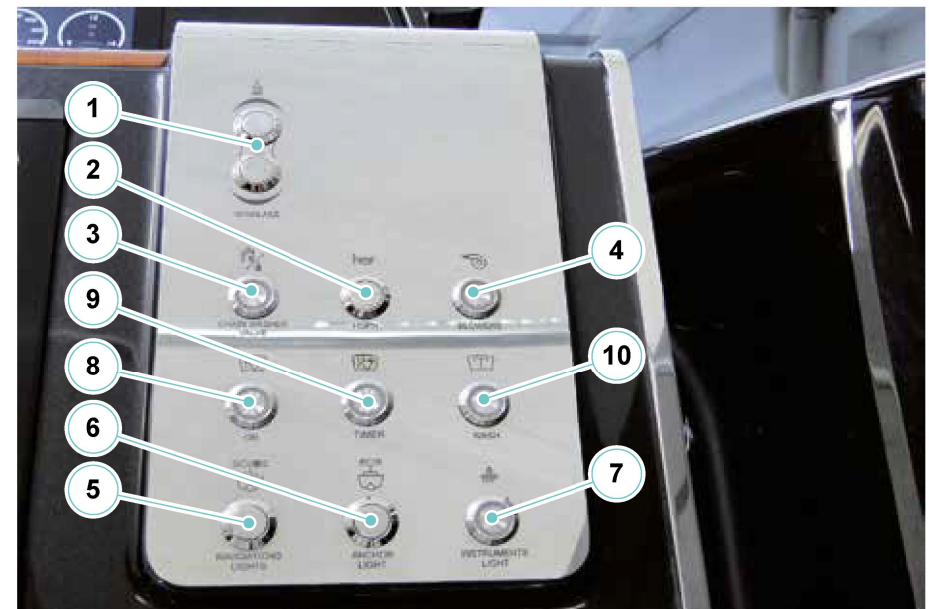

## 4.1.3 Bottom section

The bottom section of the helm position has the following utilities:

1. Speaker
2. Radiotelephone VHF-DSC  
It is a radiotelephone with selective call (DSC). The emergency and call keys are protected against the accidental use. Individual or group calls can be made suitably via the keyboard using the internal list or dialling the number directly.  
Your yacht is equipped with a AIS system.  
AIS (Automatic Identification System) is a communication system for the exchange of navigation data.
3. USB port

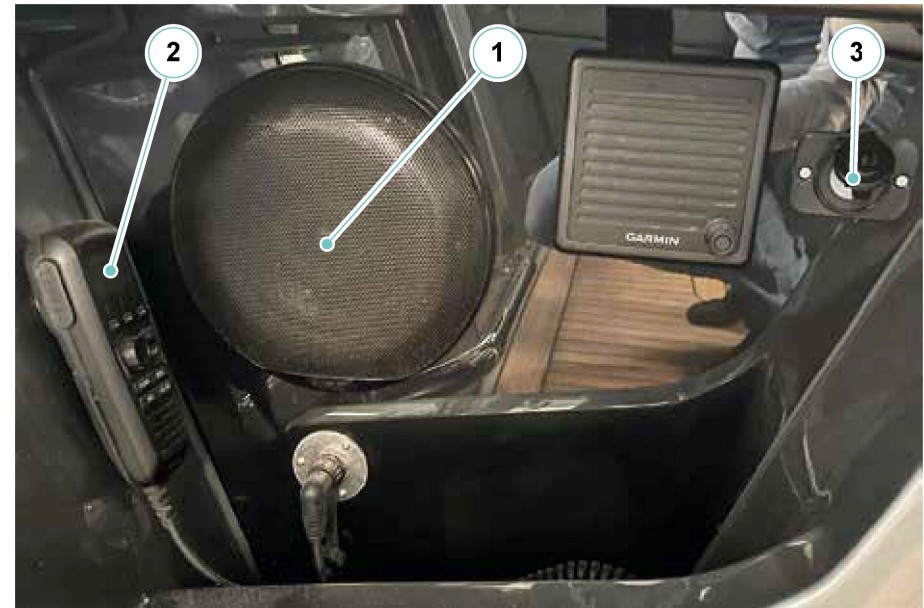

#### 4.1.4 Starboard side section

The starboard side section of the helm position has the following utilities:

1. Synoptic panel  
It allows to activate and monitor the operation of the bilge pumps and to turn ON the on-board lights by means of apposite buttons and indicator lights.
2. Engine and thruster control joystick  
It allows to manoeuvre at low speed by controlling main engines and thrusters separately.
3. Throttle  
It controls the propulsion engine revolutions and the inverter gears by means of electrical signals.
4. Engine start/stop buttons  
They allow to start and stop the propulsion engines.  
It also allows to stop engine in case of emergency, if necessary.
5. SD card slot

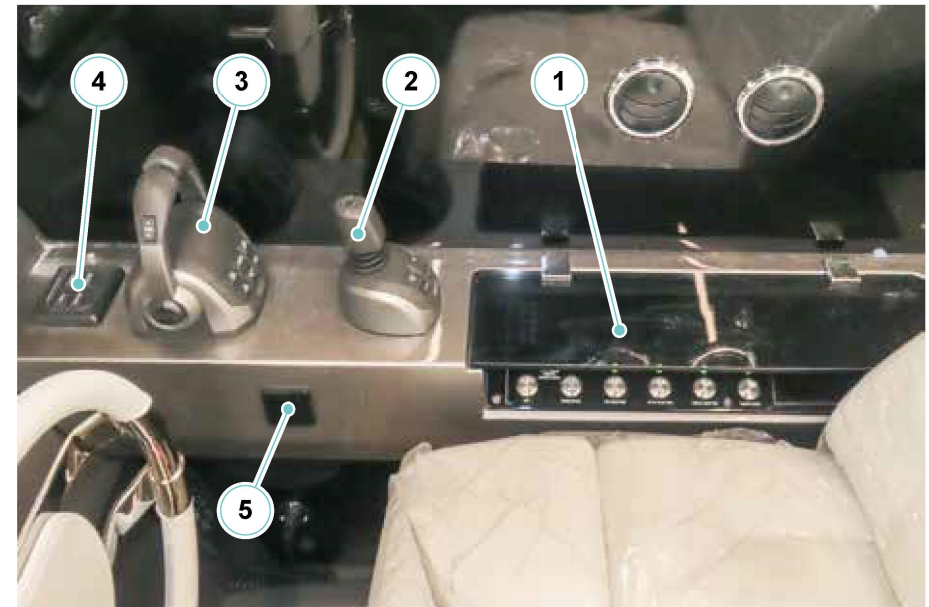

4.1.5 Field of view from the helm position

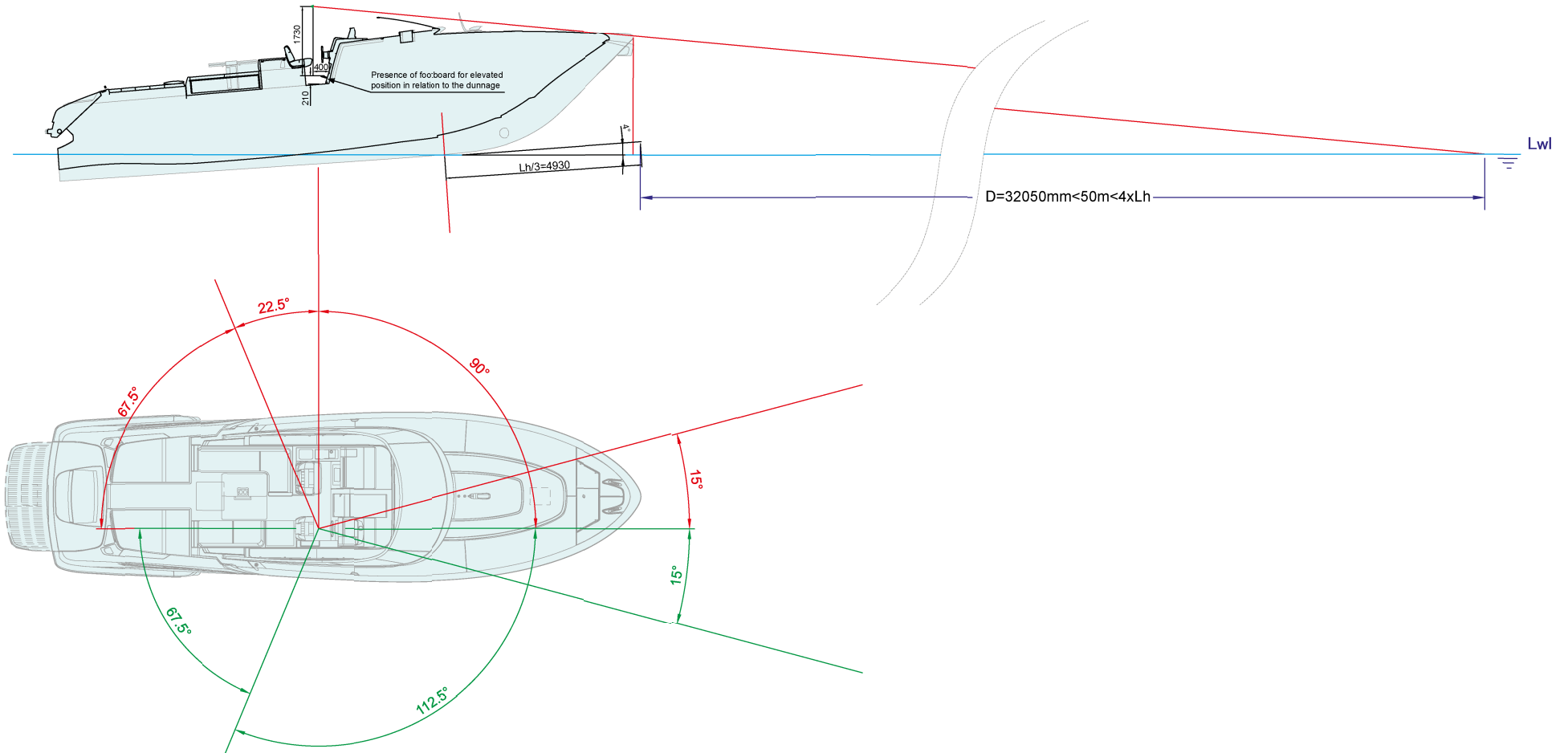

## 4.2 NAVIGATION INSTRUMENTS

### 4.2.1 Radar / chartplotter / echosounder

This instrument offers all the features of a radar, a digital echosounder and a chartplotter.

The overlapping of the radar image and of the chartplotter combined with data windows defined by the user, transform the device in a true and real integrated navigation system.

By means of the remote control, all functions and controls of the various instruments are accessible, allowing a safe navigation.



#### CAUTION

Pay the utmost attention during navigation, because in proximity of the yacht a shadow cone is formed, which is not covered from the radar waves.



#### DANGER

Radiation danger.

The radar aerial emits radiations, which can damage the human body, especially the eyes. When the radar is operating, never look straight at the transmission aerial from a distance shorter than 1 m (3,3 ft).

During the radar operation it is necessary to keep out of the aerial transmission flow.

Switch OFF the radar if not expressly necessary to navigation.



#### CAUTION

The electronic chart is an aid to navigation, designed to facilitate the use of authorized government charts, not to replace them. Only official government charts and notices to sailors contain all information needed for the safety of navigation and, as always, the Captain is responsible for their proper use.

#### NOTE

For further information on use and maintenance, please refer to the manufacturer's manual.

#### 4.2.2 Magnetic compass

The magnetic compass fitted on the dashboard of a yacht of such size, is inevitably close to the magnetic fields produced by the electric and electronic systems on board. Compass turns for compensation must be carried out by a specialized technician.

We remind you that the compensation should be carried out a couple of weeks after the launching, in order to eliminate the magnetization developed during the construction of the yacht.



#### CAUTION

The yacht is delivered with a compass not compensated. The compass compensation has to be carried out at Owner's responsibility, after the installation of any additional electronic equipment, and should be performed by an authorised and qualified technician. Any electrical or metallic items located in its proximity may influence the compass.

#### NOTE

At least once a month check the operation and the deviations. When necessary have it calibrated and compensated again.

#### NOTE

For further information on use and maintenance, please refer to the manufacturer's manual.

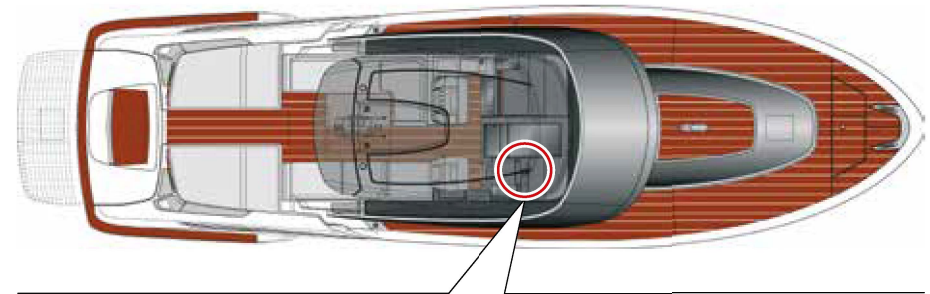

### 4.3 SYNOPTIC PANEL

The synoptic panel is situated starboard the helm position and features the following controls:

1. Light testing button  
If pressed, it turns ON all of navigation lights to check any malfunction.
2. Windshield wiper by-pass button  
It allows to activate windshield wiper by-pass. It powers the windshield wiper engine directly up to the highest speed by-passing the control unit. The relevant light signals its proper operation.
3. Crew cabin bilge pump button  
It allows to start the bilge pump in the crew cabin. The “PWR” light signals that power supply of pump is available, while the “ON” light indicates the actual operation of the pump.
4. Engine room bilge pump button  
It allows the activation of the engine room bilge pump. The “PWR” light signals that power supply of pump is available, while the “ON” light indicates the actual operation of the pump.
5. Cockpit light button

**NOTE**

Moreover, is possible to control the functioning of the navigation lights by means the indicators located above the yacht profile. Other indicators allow to control the functioning of the fresh and sea water pumps and interceptor.

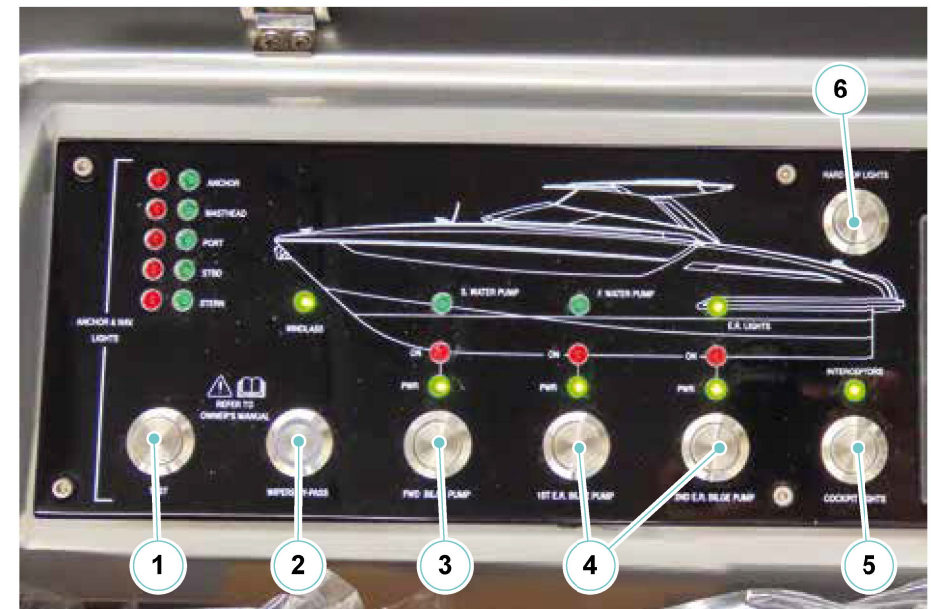

6. Hard Top light button

#### 4.4 ENGINE AND THRUSTERS CONTROL JOYSTICK

The engine and thruster control joystick **(1)** consists of an activation button (ON/OFF) and of a multidirectional joystick.

The joystick controls the 24V electric engine that allows the bow thruster rotation and the engine manoeuvre control.

By remote control, you can access all the functions and commands of the various tools allowing safe navigation.

To operationalize the thruster commands need to turn ON the magneto-thermal.

**NOTE**

Remember to disconnect the power supply of the system when manoeuvres are ended or during normal navigation.



**DANGER**

During the thruster operation, pay attention to possible swimmers or small yachts which may be close to the thruster tunnel.  
Always stop the thruster before undertaking inspection or maintenance tasks by disconnecting the switches and possibly also the battery terminals.





#### 4.6 ENGINE STARTING PUSH-BUTTONS

The engine start buttons (1) must be held down to start the engines, and according to the instructions in this guide about the starting operations and stopping engines.

The start button must be held down to start the engines.

**NOTE**

For further information on use and maintenance, please refer to the manufacturer's manual.



## 4.7 VHF-RADIOTELEPHONE

The VHF device allows communication on channels dedicated to Port Authority, rescue and radio stations.

To ask for rescue it is necessary to use the suitable VHF/FM channel: after each hour, as a law rule, follow 6 minutes of silence, from minute 0 to minute 3 and from minute 30 to minute 33, so as to enable a better listening of the distress communications.

If the VHF is used, the distress call must be preceded and ended by the wording **“MAYDAY, MAYDAY, MAYDAY”**.

It is therefore necessary to give your position, the yacht’s name, the kind of damage and the kind of help you require (medical, mechanical, etc..).



### CAUTION

Perform the **“MAYDAY”** rescue call, only in case of real need.

If, listening to the distress channel, a distress call that has not yet received an answer is picked up, it is possible to send a **“MAYDAY RELAY, MAYDAY RELAY, MAYDAY RELAY”**, forwarding the communication of the person who requested rescue.

It can in fact happen that the distress call, carried out at open sea or by means of a poorly powered sender, is not received by the rescue team. Acting as a spokesman, you can make the message reach its destination successfully.

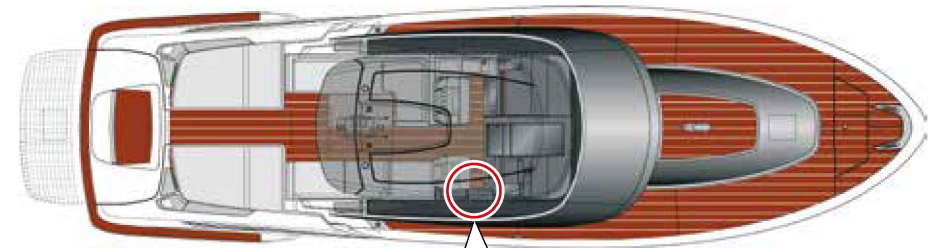

**CAUTION**

Perform the call “**MAYDAY RELAY**” only if there is a reasonable certainty that the message has not been collected by the rescue team so as not to engage uselessly the distress channel.

The use of the standard procedure avoids making confusion and shortens the transmission time. In case of danger, use only the phonetic alphabet recommended.

The VHF device is a vital and important communication line; please remember some fundamental rules:

- No transmission should be performed without reason;
- Listen before transmission so as to avoid interference with other senders;
- For distress calls use and hold the best possible wireless contact;
- Always use your call identification or the name of the yacht in order to make yourself identifiable. The use of names or family names is not allowed;
- Send short and clear messages;
- For distress calls it is important to give the yacht's position, the kind of danger, the time passed in water, the kind of yacht and the number of persons involved;
- For other calls, once established the contact with the person called, transfer the call on an operation channel;
- Cut out transmission if required by a coastal station;
- Retune the radio when the call is ended.

Operate the radiotelephone according to following instructions:

- Supply the radiotelephone with the magneto-thermal switch located on the main electrical panel.
- Press ON/C key; as default setting the device switches on the priority channel (16) frequency. If the function “LAST CHANNEL USED” has been previously set, the radiotelephone will switch on the frequency of the last channel selected.

The display shows the channel number and the volume and squelch levels.

**WARNING**

For the selection of channels and activation of the particular functions of the radiotelephone, please refer to the specific manual supplied by the manufacturer.

The keyboard has digital keys for the selection of the channels and function keys for the adjustment of the volume, of the squelch and of the scanning function.

The SHIFT key allows the access to the secondary functions.

The PTT key (press for transmission) located on the port side of the device, is activated when the receiver is unhooked from the holder.

Key 16 allows selecting the channel for vocal rescue request. It is however possible to carry out selective digital calls, quicker and simpler than the traditional calls. To obtain this, lift the protection flap placed on the front side of the radiotelephone. Then press the DISTRESS key to get access to the various functions.

Use keys ▲ and ▼ to scroll the various distress grades available:

- Not defined (default setting)
- Abandonment
- Piracy
- Man overboard (MOB)
- Fire
- Flooding
- Collision
- Grounding
- Listing
- Sinking
- Adrift

Keep DISTRESS key pressed to start countdown 5 seconds before the message is sent.

Press ON/C to return to normal mode.



### CAUTION

The DSC-call should only be made if the yacht is in a real distress situation. Otherwise, to send a DSC-call with no need is considered as an infringement.

### MANUAL DISTRESS CALL:

- Select the distress channel by pressing key 16/9 or by scrolling the channels with the volume keys.
- Press the transmission key “PTT” on the radiotelephone and perform the call.

### MAYDAY - MAYDAY - MAYDAY THIS IS:

Repeat the yacht’s name for 3 (three) times.

### MAYDAY THIS IS:

Repeat the yacht’s name.

### AT POSITION:

Specify the position of the yacht.

### SPECIFY THE DISTRESS CAUSE.

- Release the “PTT” transmission key.
- Wait for the reply for a few seconds.
- If you do not receive any reply, repeat the message at regular intervals, until receiving a reply.
- When you receive an answer, continue the conversation:
  - Hold down “PTT” while talking.
  - Release “PTT” while listening.
- It may be required to switch to a working channel.

### AUTOMATIC DISTRESS CALL:

- Lift the cover and press DIST key, the display will show the wording “Distress call Undefined”.
- Hold DIST for about 3 seconds, then displays the message: “DISTRESS CALL SENDING” and the radio beeps.
- The distress message will be sent automatically and repeated at irregular intervals on Channel 70. The channel 16 will be available for communication after each transmission.
- If you receive no response after a short time, try to send the distress message manually.



### WARNING

After the automatic SOS has been activated, must be turned OFF by pressing the ON/C, otherwise the message aid continues to be transmitted. The SOS function is automatically locked until the number of DSC has not been inserted. Consult the manual provided by the manufacturer for the correct insertion operations.

- You can press ▲ or ▼ to scroll through the transmitted Distress call information.
- You now have the following soft-key options:

#### **RESEND**

Displays “HOLD DISTRESS 3 SECONDS TO SEND”. You can then:

- Hold down the red “DISTRESS” key for 3 seconds to resend the call;
- Press the “EXIT” soft key to return to waiting for an acknowledgement.

#### **PAUSE**

Pauses the call repeat mode. You can then:

- Press the “EXIT” soft key to resume the same call.

#### **CANCEL**

Displays “DISTRESS CALL SEND CANCEL.” You can then:

- Press the software button “NO” to return to waiting for a confirmation of receipt;
- Press the “YES” software button to send the “DISTRESS CANCEL” signal;
- Press “PTT” and report your situation using the handset;
- When finished talking, press “X” to return to standby mode.

#### **NOTE**

For further information on use and maintenance, please refer to the manufacturer’s manual.

NOTES:

<hr/> <hr/> <hr/> <hr/> <hr/> <hr/> <hr/> <hr/> <hr/> <hr/> <hr/> <hr/> <hr/> <hr/> <hr/> <hr/> <hr/> <hr/> <hr/> <hr/> <hr/> <hr/>	<hr/> <hr/> <hr/> <hr/> <hr/> <hr/> <hr/> <hr/> <hr/> <hr/> <hr/> <hr/> <hr/> <hr/> <hr/> <hr/> <hr/> <hr/> <hr/> <hr/> <hr/> <hr/>
---	---

*Riva*

DOLCERIVA

NOTES:

---

---

---

---

---

---

---

---

---

---

---

---

---

---

---

---

---

---

---

---

---

---

---

---

---

---

---

---

---

---

---

---

---

---

---

---

---

---

---

---

---

---

---

---

---

---

---

---

---

---

---

---

*Riva*

DOLCERIVA

5 - ON-BOARD SYSTEMS

## 5.1 ELECTRICAL SYSTEM

The electrical system of your yacht has been designed with the utmost attention to all aspects of safety. The system has been manufactured and installed using high-quality materials that meet or exceed industry standards. The installation has been carried out in compliance with the rules of the Naval Italian Register of Shipping (R.I.N.A.), of the Italian Electrotechnical Committee which regulates the electrical installations of pleasure yachts.

The yacht electric system consists of three distinct and separated sections:

- Service mains supplied by a nominal current of 24V DC.
- Service mains 230V 50Hz supplied from shore, or alternatively, by the power generator installed on the yacht. The generator set is supplied by a set of 12V accumulators located near the generator and is re-charged by an alternator, driven by the same unit.

All the electric cables have been insulated with non-flammable PVC N07V-K/FS17 plastic material. The cables are numbered for ease of maintenance, and they are sheathed in self-extinguishing PVC, for additional protection. Regular maintenance and proper use of the system will contribute greatly to its continued safety. Like any other system on board, the electric system is subject to the stresses and vibrations of the hull. In addition, the electric system is exposed to high levels of corrosive salt humidity. Check the system and its components according to a maintenance schedule.

The electrical system statistically represents one of the most common causes of fire on board.

There are two separate electrical systems on board, each having unique features:

- 24V DC;
- 230V AC (50Hz).

The DC systems are powered by 4 storage battery groups that supply power to engines (24V), services (24V), and auxiliary services (24V). The AC system is powered by either the shore power system or by the on board generator.

All the electrical services are protected by magneto-thermal switches (single pole and double pole for 24V, double pole for 230V) and a ground-fault magneto-thermal/switch with a sensitivity of 0.03 A that protects the entire 230V AC system against accidental short-circuit contacts.



### DANGER

Risk of electric shock from leakage currents.  
Do not swim in harbour or marine waters.

### NOTE

#### Systems and electric circuits

For the diagrams and the features of the electric system parts, please refer to the specific manual.



### CAUTION

Before undertaking any navigation, check that the batteries are in good condition and that they supply the correct nominal current.



### CAUTION

During navigation, always keep connected both the service battery switch and the engine batteries one on ON position. The parallel switch ON the two banks must be normally disconnected and then on OFF.

**CAUTION**

For proper fuse replacement procedures refer to the on-board electrical manual delivered separately.

**NOTE**

If, during navigation, an operation fault on the re-charging alternators occurs, fault which is indicated by the relevant control light on the engine dashboards, set the lever-switch of the battery sets' parallel connection to ON and keep it activated until the fault has been solved.

**NOTE**

If there is a noticeable and persistent drop in battery voltage during navigation, the power generator must be switched on and it must be ensured that the independent electric charger is activated.

**CAUTION**

The parallel system between the banks of batteries serves to increase the inrush current during the engine ignition stage in particular weather conditions or recharging state for a limited period of time.

It must be activated only with the connection switches of the banks of engine and service batteries on ON position.

Do not use in case of faults on the batteries recharging circuits, for instance on the engines alternators. We advise to use this system only in emergency cases.

**DANGER**

The engines checking systems: accelerator and gears engagement remote controls are electronic. Their reliability is very high, but in case of a sudden black-out, it is necessary to immediately switch OFF the engines which is not controllable any more, by means of the relevant buttons located in the helm position.

**DANGER****NEVER:**

- Work on the electric system while under voltage.
- Modify the electric systems of the yacht or relevant drawings: the installation, the modifications and the maintenance must be carried out only by a skilled marine electrician.
- Alter or modify the intensity of rated current of protections against overcurrent.
- Install or change electric equipment or devices with components exceeding the rated current intensity of the circuit.
- Leave the yacht unguarded with electric system under power, except for the circuits of the bilge automatic suction pumps, of fire-fighting protection and of alarm.

**CAUTION**

Do not modify the electric systems of the yacht or relevant drawings. The installation, the modifications or the maintenance must be carried out only by a skilled naval electrician. Inspect the system at least once a year.

**NOTE**

Disconnect the shore power supply connections when the system is not in use.

Use electrical equipment with double insulation or grounding.

**DANGER**

Do not allow that end of the shore power cable to float in water. An electric field may be generated which can cause injury or death to bathers nearby.

**DANGER**

To minimise shock and fire hazards:

- Turn OFF switch for connection to shore supply of the yacht, before connecting or disconnecting the shore power supply cable;
- Connect the shore power supply cable to the intake socket of the yacht, before connecting the shore power supply source;
- Disconnect the shore power supply cable first from shore source supply;
- Close the cover of the shore power socket firmly.

**NOTE**

Do not modify the connectors of the shore power supply cable.  
Use only compatible connectors.

**DANGER**

Electric shock hazard exists in an energized electrical system. To avoid electric shock that can cause serious injury or death, turn OFF power before opening the cover and servicing any internal components of electrical equipment.

**DANGER**

Operate all electrical equipment and systems (including low voltage systems) with special attention. Avoid overloading to prevent short circuits, dangerous overheating, and potential fire hazards that can lead to serious injury or death.

**DANGER**

The 230V AC system is similar to a domestic system in its characteristics and hazards. If improperly operated or maintained, it can cause a fire or personal injury or death.

**CAUTION**

Do not disconnect the battery breaker switches with engines running or you may damage the engine alternators.

**CAUTION**

Only a skilled naval technician can perform maintenance on the yacht's electric system.

**CAUTION**

Have the thermal magneto-thermals, main electrical panel and other components of the electric system checked by an authorized RIVA electrician, to ensure the correct operation and to detect any signal of overheating.

**DANGER****SHOCK/FIRE HAZARD**

Replace breakers or fuses with parts with the same amperage. Never alter overcurrent protections.

**DANGER**

**CAUTION!** Risk of electric shock from leakage currents. Never swim in waters near harbours or marinas.

**DANGER****EXTREME DANGER:**

- Never use open flames in the battery storage area.
- Prevent sparks from reaching the battery.
- The battery can explode if, while charging, a spark or a flame turn ON, due to the hydrogen released.

**DANGER****SHOCK/FIRE DANGER:**

Disconnect the electric system from the mains before starting any maintenance work. Never perform any maintenance work on the electric system while under voltage.

The electric devices should never exceed the rated voltage of the yacht electric circuits.

Check carefully the electric system while under voltage. The only electrical components that do not require any supervision, are the bilge automatic pumps, the fire-fighting protection circuits and the alarm circuits.

**CAUTION**

Stop the engine before inspecting the battery or servicing it. Disconnect the battery cables before working on the electric system in order to prevent the generation of arcs or damaging the alternator. Disconnect the negative cable (-) first, then the positive cable (+).

**DANGER****Explosion/fire danger**

Check if gas fumes are suspended in the bilge or in the generator area.

**DANGER****CARBON MONOXIDE POISONING**

Start the generator only in a well ventilated area. The carbon monoxide, generated by the inner combustion of engines, is extremely toxic. If the carbon monoxide monitor indicates "DANGER", immediately turn OFF the generator and investigate cause.

**DANGER****SHOCK HAZARD**

People with heart problems or other conditions which make them susceptible to electric shock may still be injured by ground faults on circuits protected by GFI (Ground Fault Interrupter) outlets. No safety devices yet designed will protect against all hazards or carelessly handled or misused electric equipment or wiring.

**CAUTION**

The use of pressurised water on light fittings installed outdoors is prohibited.

**CAUTION**

Check the polarity of shore power when energizing the main breaker. Reverse polarity may damage the equipment.

**CAUTION**

Make sure that the electric system of your yacht is connected to the correct amperage. The yacht's AC system has no protection against surges, spikes and transients generated by AC power supply, often associated with unknown power sources.

## 5.1.1 Fuse

On your yacht, the electrical protection fuses are located in the storage cabin, inside the side panels above the bed.

### NOTE

For their placement, refer to the wiring diagrams.



### WARNING

Where there is the necessity of having to replace a fuse, proceed to its replacement with a new one having the same characteristics in order to avoid damage to the load board.

### NOTE

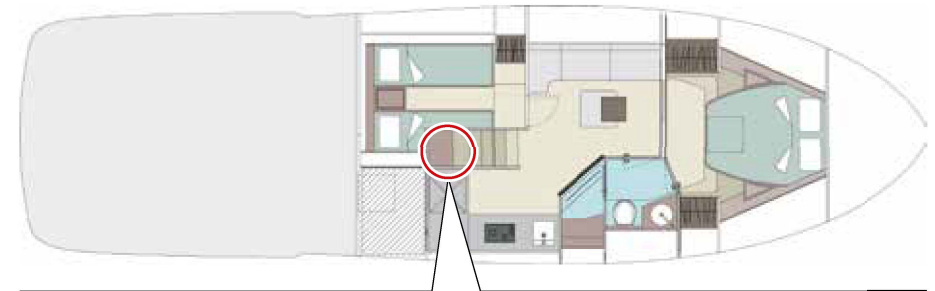

For more information on the wiring diagrams, refer to the electrical manual supplied by the Manufacturer.

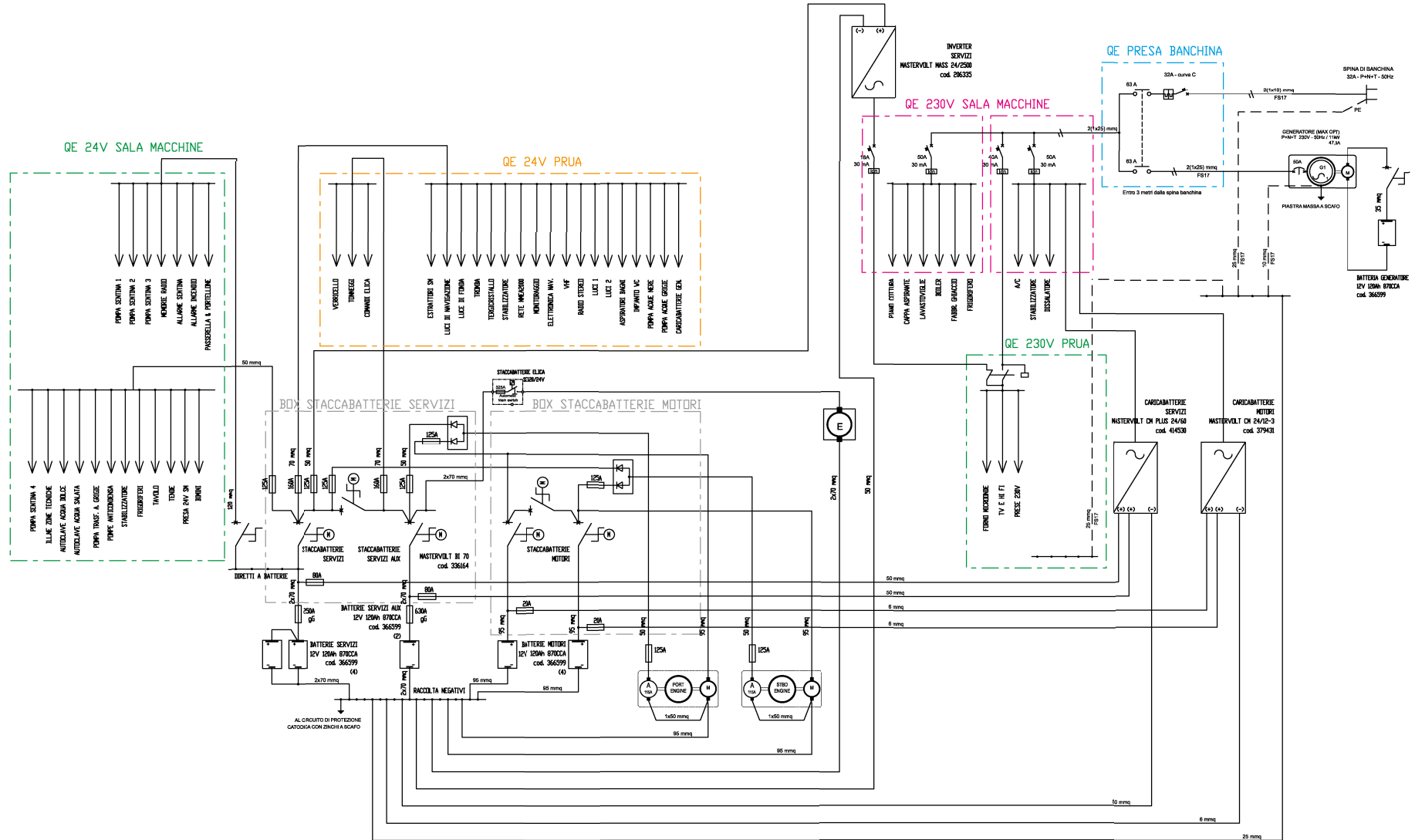

5.1.2 AC-DC distribution diagram



5.1.3 Maintenance of the electric system

Component	Maintenance	Notes and precautions
Equipment and circuits	Inspection and cleaning	<p>At least once every 2 weeks, have the status of the connections in the electric boards, panels and boxes checked by experienced and equipped personnel. Make sure that ground connections of electric equipment and electrical panels are tight and not oxidized. Have the absorption of the different electric engines periodically checked by skilled personnel.</p> <p>When cleaning the bottom hull, carefully clean the electronic instrument ground static discharger and the porous plate to which is connected the power generator grounding. Moreover, check the condition of the protection anodes and if necessary, replace them. During the lay-up period, do not apply any antifouling on the ground static dischargers.</p> <div style="border: 1px solid black; padding: 5px; margin: 10px 0;"> <p style="text-align: center;"><b>NOTE</b></p> <p>At least once a week check the operation of all electrical panels. At least once every six months:</p> <ul style="list-style-type: none"> <li>• Check the possible presence of damaged cables;</li> <li>• Protect the various contacts.</li> </ul> </div> <div style="border: 2px solid red; padding: 10px; margin: 10px 0; text-align: center;">  <p><b>DANGER</b></p> <p>Before working on panels or electrical equipment, prevent generator functioning, disconnect shore power and inverters.</p> </div> <div style="border: 2px solid red; padding: 10px; margin: 10px 0; text-align: center;">  <p><b>DANGER</b></p> <p>Do not modify the electric systems for the yacht or relevant drawings. The installation, the modifications or the maintenance must be carried out only by a skilled naval electrician. Frequently inspect the system.</p> </div>

Underwater lights on the transom

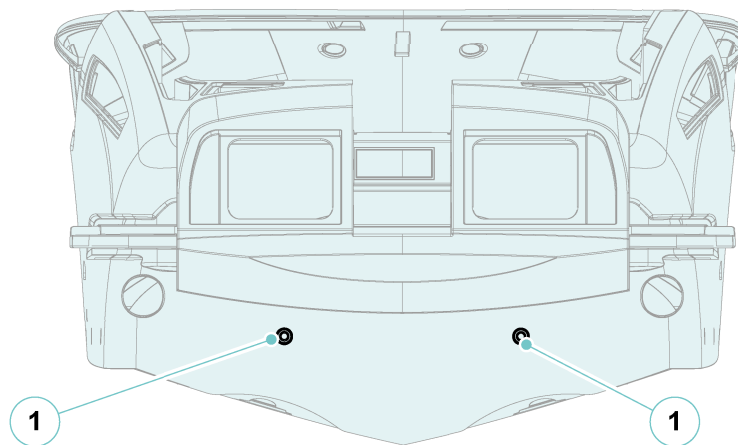

Underwater lights on the side

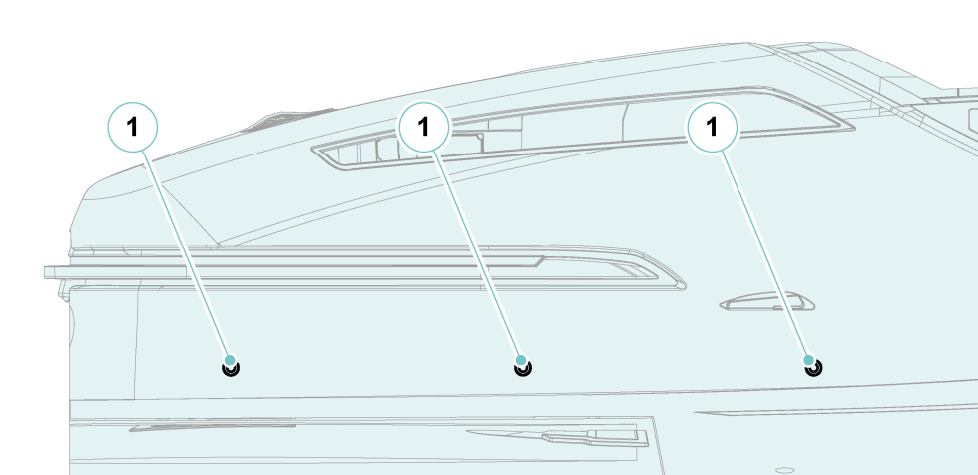

1. Underwater headlight

### 5.1.4 Battery set

The batteries of propulsion and service engines of the yacht are situated in the engine room in apposite protective containers at stern close to the generator and fore close to the port engine.

Batteries are usually recharged during their operation by the alternators driven by the propulsion engines.

As an alternative, they can be recharged through a special battery charger supplied by the main electrical panel, from shore or by turning ON the on-board generator.

The batteries are divided on the yacht as follows:

- Port engine batteries (n°2) 12V 120Ah (1).
- Starboard engine batteries (n°2) 12V 120Ah (2).
- Service batteries (n°4) 12V 120Ah (4).
- Auxiliary services batteries (n°2) 12V 120Ah (5).
- Generator battery (n°1) 12V 120Ah (3).

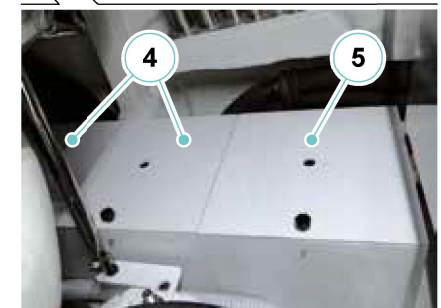
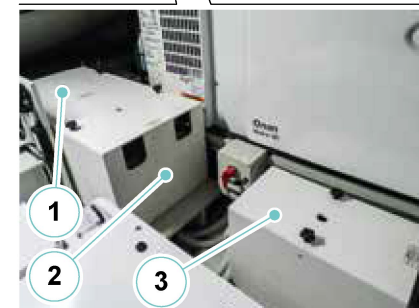
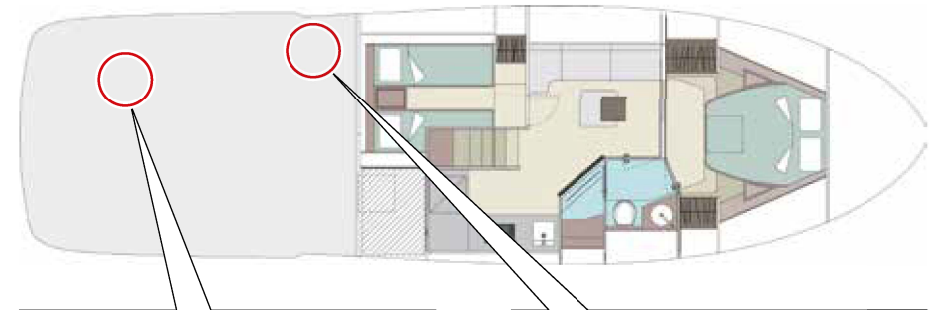

**DANGER**

NEVER obstruct the air intakes of the battery boxes, as natural ventilation must always be allowed for the batteries so that they do not overheat.



**CAUTION**

The batteries left unloaded over long periods of non operation, loose progressively their charge, until they become completely flat and get irreparably damaged.



**CAUTION**

Do not lay objects on the cases containing the batteries.

**NOTE**

A frozen battery may blow up if used or charged; do not start a yacht with frozen battery. To prevent the battery from freezing keep it always completely charged.



**DANGER**

The battery releases explosive gas: do not approach flames or sparks or smoke near the battery. If the battery is used or charged in an enclosed area, ensure that there is good ventilation. Do not check the battery charge status by short-circuiting the terminals with metal tools: use a densimeter or voltmeter



**WARNING**

**EXPLOSION HAZARD**

Any lithium battery powered device on board must be recharged only in open air areas, connected to a suitable charging system. Also please refer to the device dedicated Use and Maintenance Manual.

The box with the protection fuse (1) of the battery recharging line is situated astern the engine room.



### 5.1.5 Battery breaker panel

Battery switches (battery breakers) are installed in the yacht.

The battery breakers allow connecting, or cutting OFF, the batteries to/from their circuits.

- **Generator battery breaker (1)**  
This switch allows cutting in or out the generator battery and is located in the engine room at the side of the generator.
- **Stern thruster battery breaker (optional)**  
Enables or disables the power supply of the stern thruster.
- **Bow thruster battery breaker (2)**  
Enables or disables the power supply of the bow thruster.
- **Security systems and gangway battery breaker (3)**  
Enables or disables bilge pumps, alarms and gangway.



**DANGER**

Always keep the main breaker for safety systems and gangways in the ON position. Only disconnect in the event of maintenance or a fault.

- **Switch battery enable (4)**
- Enable or disable the battery breaker buttons
- **Service battery breaker button (5)**  
This button allows cutting in or out the service battery set.
- **Auxiliary service battery breaker button (6)**  
This button allows cutting in or out the auxiliary service battery set.
- **Service/auxiliary service battery parallel connection (7)**  
If the service batteries are flat or not sufficiently charged for starting the propulsion engines, the battery breaker allows the parallel connection between service battery set and the auxiliary service set, thus enabling the start of the service batteries.

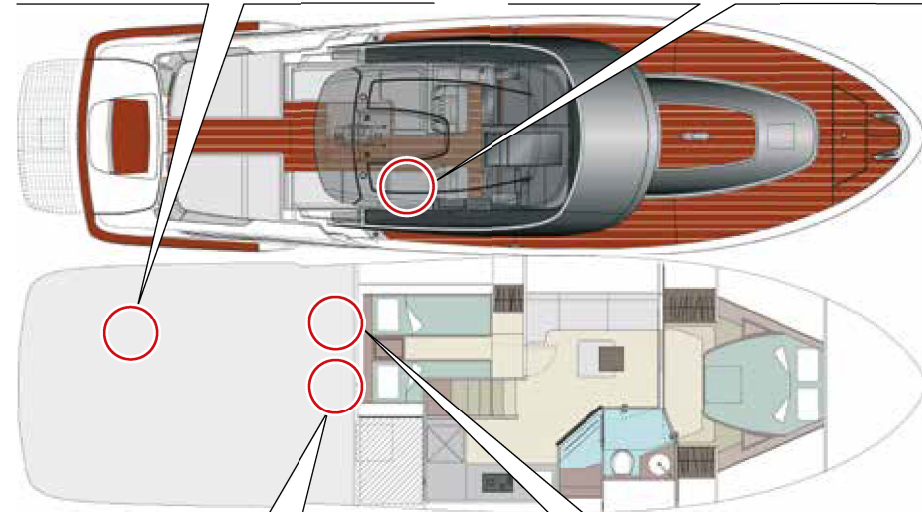
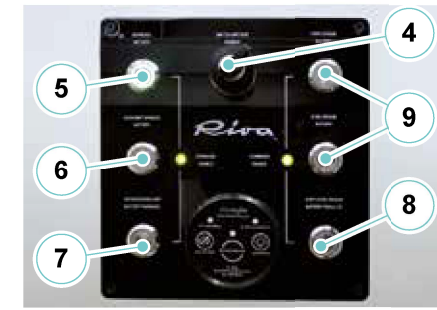
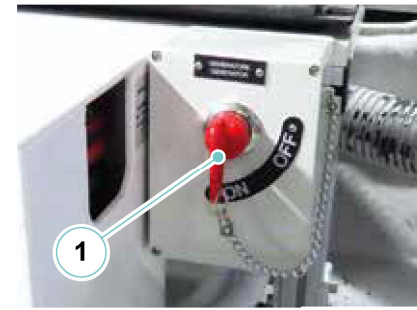

- **Port/starboard engine battery parallel connection (8)**  
If the engine batteries are flat or not sufficiently charged for starting the propulsion engines, the battery breaker allows the parallel connection between port engine battery set and the starboard engine battery set, thus enabling the start of the engines.
- **Engine battery breakers buttons (9)**  
This buttons allows cutting in or out the engines battery set.

**CAUTION**

This connection must be activated only if the engine batteries are not sufficiently charged. The battery parallel connection switch, must be activated only with buttons connecting the service battery banks and the engine banks set to ON.

**CAUTION**

Never disconnect the battery breakers with the engines running, because the engine alternators could get damaged.  
Use the “Service/engine parallel connection” battery breaker only if strictly necessary and disconnect it as soon as possible.  
Leave the battery-powered service battery breaker always connected.

**5.1.6 Maintenance of the batteries**

Component	Maintenance	Notes and precautions
Batteries	Electrolyte level check	Do not wear any bracelet, ring or any other jewel when operating on batteries.
	Terminal inspection	These maintenance operations must be carried out by expert staff only. Batteries may be subject to explosion hazard, with subsequent risks of serious personal injuries.
	Charging performance check	Do not use naked flames, do not smoke, do not cause sparkles or use arc-welders in the area where batteries are located. Electrolyte may cause burns and serious injuries to eyes. Wear safety goggles and protective clothing.  In case of contact with battery acid, rinse immediately the contaminated body areas with fresh water for at least 15 minutes.

### 5.1.7 Charge of the batteries

The batteries left uncharged over long inactivity periods progressively lose their charge, until they become completely flat and get permanently damaged.

During the yacht's idling periods, have the battery terminals disconnected, or leave them all connected and have all batteries, generator included, charged periodically.



#### CAUTION

Do not disconnect battery cables when the engines or the generator are running.

Always keep the batteries charged and recharge them periodically even if the yacht is left unused. If the charge level drops to the minimum, the batteries can get irreparably damaged.



#### CAUTION

Monitor the batteries charging voltage.

During the recharging phase, 29,1V can be reached, which is a temporary value, well tolerated both by the batteries and by the battery charger. This value must be monitored and, if this situation lasts for too long, the magneto-thermal switch of the battery charger must be disconnected.



#### DANGER

During recharge the batteries produce explosive gas. Do not approach to recharging area with free flames or sparkles.

Avoid wrong connections; never connect a positive terminal (+) with a negative one (-).

During battery recharge, remove the caps of the relevant elements.

### 5.1.8 Battery check (accumulators)

Carry out following checks:

#### Electrolyte level

- Restore the level with distilled water by removing the caps from the battery elements. The electrolyte level must be between the Max. and Min. references of the same battery.



#### CAUTION

Never top-up with sulphuric acid or other solutions different from demineralised or distilled water.

#### Terminal inspection

- Check that the battery containers are clean and dry and that the terminals are coated with silicon grease and properly fastened. Clean and grease as required. Check at least every six months.
- Positive and negative cables must be identified before connection (connect the positive terminal first and then the negative, in order to avoid sparkles).



#### CAUTION

A battery with the electrolyte frozen may blow up if used or charged; do not start a yacht with frozen battery.

To prevent the battery from freezing keep it always completely charged.



#### DANGER

Always remove the negative terminal (-) for ground connection first and connect it last.



#### DANGER

Electrolyte may cause burns and serious injuries to eyes. Wear safety goggles and protective clothing.  
This maintenance operation must be carried out by expert staff only.



#### DANGER

Batteries may be subject to explosion hazard, with subsequent risks of serious personal injuries. Do not use open flames, smoke, cause sparks or use arc-welders in the area where batteries are located. Do not disconnect battery cables when the generator is running.  
Battery acid may cause serious injuries. Wear safety goggles, gloves and protective clothing.  
Do not wear any bracelet, ring or any other jewel when operating on batteries.  
In case of contact with battery acid, wash the contaminated part with fresh water for at least 15 minutes and consult a doctor.

### 5.1.9 Battery charger

On board your yacht there are three fully automatic and heavy duty battery chargers: for recharging service banks and auxiliary services (1), for recharging the two engine banks (2), and for recharging the generator (3).

The battery chargers are equipped with an optimized charge for a quick and safe recharging, though powering the connected systems. Besides, the battery chargers are protected against short circuits, overloads, and high temperature (engine room).

The front side of the battery charger is equipped with LEDs indicating the status of the delivered current.

The ChargeMaster is equipped with a multicolour LED display. Different LED colours and combinations have different meanings.

The display in association with the charging bar shows the percentage of maximum current of the battery systems together.

The symbol (V) in combination with charging bar shows the actual load voltage.

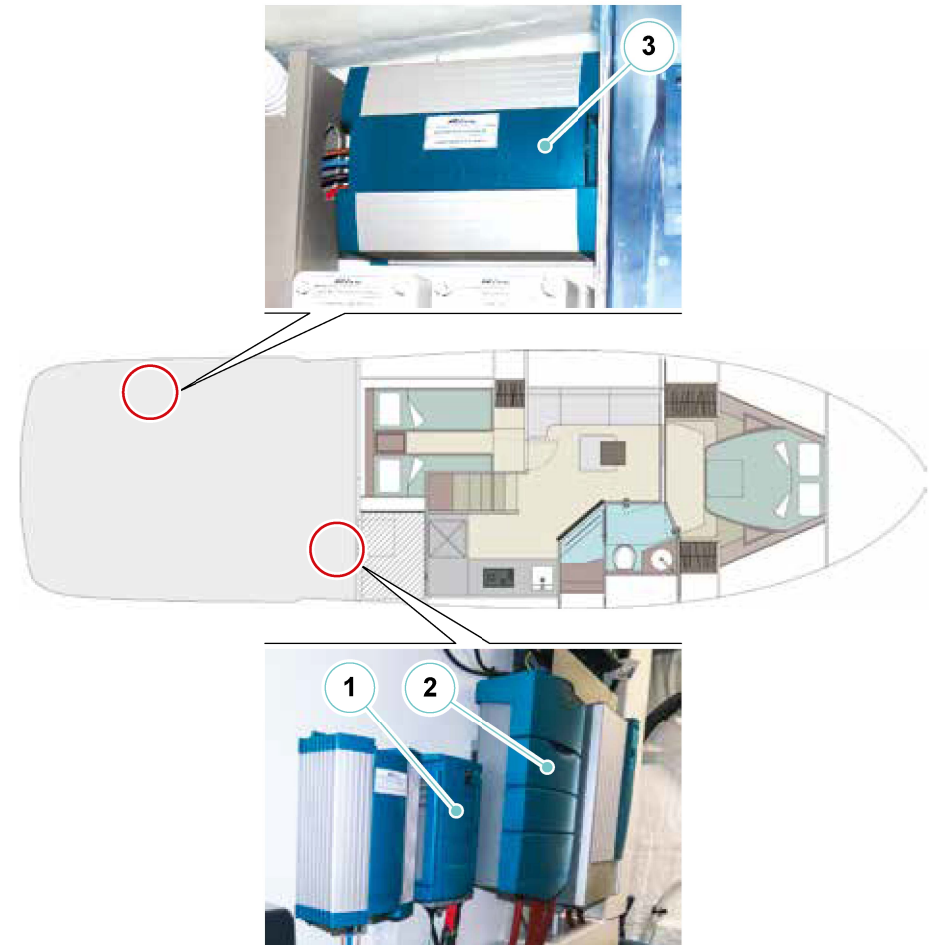

- A. Load bar.
- B. Actual stage of the three step charge algorithm: Bulk, Absorption and Float.
- C. Power LED.  
Green = ON,  
Red = standby.  
Blinking red = failure
- D. SET button.

Power LED green	Yellow LED (Setting mode)	Power LED blinking red
Current 100%	Connected to Master-Bus (read only)	Temperature error
Current 75%	MLi	Charger failure
Current 50%	2-step	Wrong AC voltage
Current 25%	Wet	Battery voltage too high
Current 5%	Gel/AGM	Battery voltage low, short circuit. Charger output reduced to 25% of its maximum.

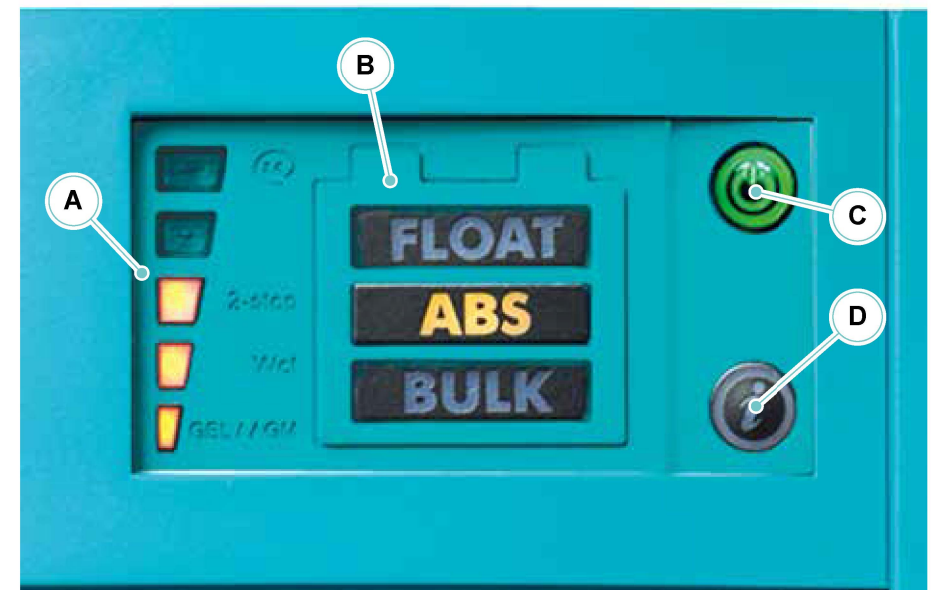

5.1.10 Battery charger maintenance

Component	Maintenance	Notes and precautions
Battery charger	Inspection charge output	<p>At least two or three times a year, have a specialist check the connection of each cable for looseness and oxidation.</p> <p>Keep the battery charger dry, clean and away from dust in order to ensure a good dissipation of heat.</p> <p>Periodically check the good condition of the cooling fan.</p>



**DANGER**

Do not work on the battery charger or on the electric system if they are still connected to a current supply. Disconnect the mains supply before connecting or disconnecting the battery.  
Modification to the electric system must be carried out exclusively by skilled personnel and only after the approval of RIVA.



**DANGER**

Have the inner condition of the battery charger checked by skilled staff at least once a year. Faults like loose connections, burnt wires, etc., with following risk of fire spreading, must be repaired immediately.



**CAUTION**

Disconnect the shore power supply connections when the system is not in use.



**DANGER**

**EXPLOSIVE GASES - AVOID FLAMES OR SPARKLES**  
Position the battery in a well ventilated area.

**MAINTENANCE**

At least once a month check the correct operation of the battery charger.  
At least once a month carry out the complete cleaning.  
At least once every six months protect the contacts with proper products.

### 5.1.11 Battery charger check



#### DANGER

Before operating on the battery charger, disable the generators start and cut-OFF the shore power supply.

This device can operate in a reliable and optimal way, only if following operations are performed:

- Check that all breakers and indicator lights are working, the wiring does not present any signs of cuts and all parts are clean and free from oxidation;
- Remove the chassis and check the electronic boards for oxidation. Clean with deoxidiser if necessary;
- Protect the electric contacts by using an appropriate product (DC4);
- Reinstall the casing after cleaning;
- Check at least once a year the connection of each cable (for loose connections, etc.);
- Keep the battery charger dry, clean and in a dedusted area to ensure a good dissipation of heat.



#### WARNING

All maintenance operations listed must be performed only by skilled personnel.



#### DANGER

NEVER obstruct the air intakes of battery boxes, as natural ventilation must always be allowed for the batteries so that they do not overheat.

### Charge output

For a good operation, batteries must not be discharged below 30-40% of their capacity, therefore, always start recharging them, when this charge level is reached.

The battery charger is equipped with a temperature sensor located close to the batteries. According to the temperature value detected, together with the value of residual capacity of the batteries, the charger automatically adjusts the charging voltage according to temperature, this remarkably increasing battery life. Moreover, besides the thermal compensation, the battery charger can also compensate the voltage drop due to the dispersion of the connection cables. The battery charger is provided with an integrated warning light which activates in case certain adjustment values are exceeded.



#### WARNING

If the engines are running, the alternators are charging the batteries, so it is advisable to keep the charger switch to OFF to avoid damaging the alternators.



#### CAUTION

Should the battery voltage drop under 18V, the battery charger will supply a current corresponding to the 25% of the maximum one and the recharge time will consequently increase.

## 5.1.12 Inverter

The inverter (1) is a device that transforms the 24V DC voltage into 230V AC.

- **ON, Switch**  
Position the ON/OFF switch, located on the front panel of the inverter to "ON". The green light "inverter ON" lights up and the inverter starts.
- **OFF, Switch**  
Position the ON/OFF switch, located on the front panel of the inverter to "OFF". The inverter stops and all lit lights switch OFF.

### Warning lights

The functions of the warning lights located on the inverter front panel are:

- **Inverter ON**  
The green light indicates when the inverter is ON.
- **Overload**  
The indicator lights up if the inverter is overloaded. When the inverter is overloaded, the power limiter reduces the voltage output. According to the load, the inverter will switch OFF after a short period.
- **Overload + ON slow**  
When the inverter remains overloaded for a long period of time, it will switch OFF and the "overload + ON" indicators will blink slowly. This takes approx. 20 seconds after which the inverter will restart automatically. This is called "wait state" and gives the inverter time to recover from any supply and gives the battery time to recover in case it is flat.
- **Overload + ON fast**  
The inverter is switched OFF. When the inverter switches OFF 10 times with intervals no longer that 30 seconds, the inverter will switch OFF permanently and the "overload" and "ON" indicators will blink fast. To switch the inverter on again, you have to switch the inverter OFF and ON again.

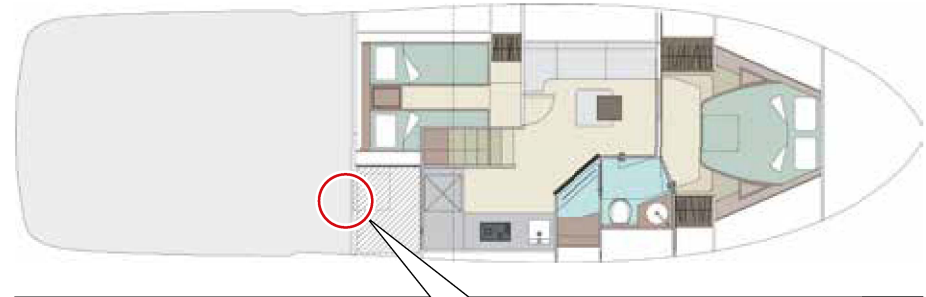

- When the output terminal is short-circuited, the inverter will overload. The “overload” and “ON” indicators will blink slowly. The inverter will try to start up ten times. If the short-circuit is not removed, the inverter will switch OFF permanently. Remove the short circuit and reset the inverter by switching it ON and OFF.
- **Low battery (nearly flat)**  
The inverter is OFF when the battery voltage is too low. If the voltage increases above certain values, the inverter restart automatically.
- **High temperature**  
The inverter switches OFF in environments at high temperature and/ or remarkable overload. After the cooling, the inverter starts automatically.



## **DANGER**

When disconnecting the inverter by means of the switch located on the front panel the connection with the mains is not broken OFF.

5.1.13 Inverter maintenance

Component	Maintenance	Notes and precautions
Services inverter	Maintenance and check	<p>At least once a year, have the cable and wire connections checked by skilled personnel; they should still be tight and not oxidized.</p> <p>Keep the inverter dry, clean and free of dust in order to ensure good heat dissipation.</p> <p>Periodically check the good condition of the cooling fan.</p> <p>If the device is OFF during the maintenance and/or repair works, it should be set to prevent an unexpected or unintentional activation:</p> <ul style="list-style-type: none"> <li>• Switch off the battery connection or remove the inverter fuse;</li> <li>• Make sure that nobody can tamper with the precautions taken.</li> </ul>



**DANGER**

Do not work on the inverter or its system if it still connected to a power supply. Only qualified technicians may carry out work on the electrical system, after approval by RIVA.



**WARNING**

The services supplied by the inverter highly stress the batteries that could discharge as a result.



**DANGER**

Have the inner condition of the inverter checked at least once a year by skilled personnel. Faults like loose connections, burnt wires, etc., with following fire break risks, must be removed immediately.

**MAINTENANCE**

At least once a month check the correct operation of the inverter.  
 At least once a month carry out the complete cleaning.  
 At least once every six months protect the contacts with specific products.

## 5.1.14 Shore supply

The yacht is equipped with a waterproof and guided connection plug, complying with the laws, to connect the 230V power grid with the shore.

It is common to find sockets on the quayside that are not of the same size as the one supplied or that have different amperages to those on the yacht; in this case, contact the harbourmaster's office for information on the type of amperage, the availability of a new plug or an adapter (provided that it is less than 32A).

This procedure has to be carried out in the reverse order to disconnect shore power supply.

To use the electric shore power supply:

- Turn OFF the main AC shore power switch located on the main electrical panel.
- Turn OFF the switch on the shore column
- Connect the shore socket cable; first connect the plug (female on the yacht) and then connect the plug (male) on the shore column.
- Turn ON the switch on the shore column.
- Select the shore source using the selector on the main electrical panel.
- Turn ON the magneto-thermal on the shore.
- Check the voltage value with the voltmeter located on the main electrical panel.
- Turn (ON) the magneto-thermal on the main electrical panel.
- Before turning ON the magneto-thermales of all uses, check the correct voltages on the voltmeter.

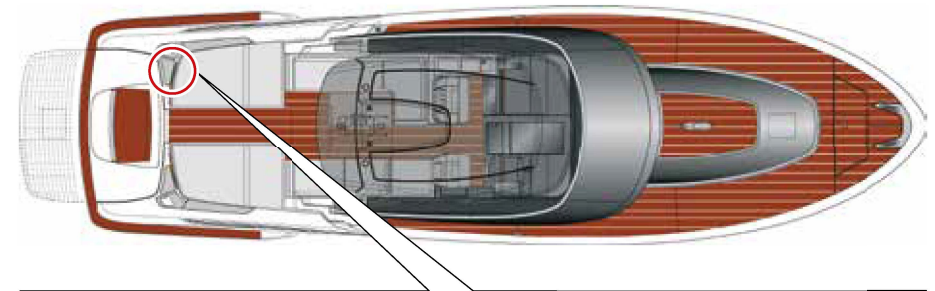

**DANGER**

Check that the shore power supply has a differential magneto-thermal protection before plugging it in.

**DANGER**

After connecting the plug to the shore, check on the voltmeter of the shore line panel that 230V 50Hz is present.

**DANGER**

Before connecting the shore socket, ensure the type of voltage and the sockets available, their integrity and the absolute absence of moisture on the wire, on the socket and on the plug.

With plug connected check that wire:

- Cannot get in traction as a result of tide variations, yacht movements, etc..
- Cannot be crushed, etc..
- Does not get in contact with water.

**CAUTION**

Do not modify connectors of shore power supply cable, use only plug compatible connectors. If the yacht power supply cable cannot be plugged into the shore socket, ask the Port Authority for an adapter.

### 5.1.15 Socket use procedure

1. Insert the socket: align the holes of the socket with the plug and push it down.
2. Lock the socket: Turn the socket slightly clockwise.
3. Remove the socket: turn the socket slightly counterclockwise and pull it out.



#### **DANGER**

Before carrying out any operation on the electrical system, disconnect all circuits and unplug the shore power supply socket.  
Before connecting to the shore power supply column, check that plug and socket are not spoiled and at any rate are perfectly dry.

#### **NOTE**

We recommend not leaving the shore cable connected when the yacht remains unattended.



#### **DANGER**

- To reduce to the lowest the hazard of electrocution or fire:
- Open the switch for connecting the yacht to shore supply, before connecting or disconnecting the shore power supply cable.
  - Connect the shore power supply cable to the intake socket of the yacht, before connecting the shore column.
  - Disconnect first the power supply cable from shore column.
  - Tightly fasten the lid of the shore power supply socket.



#### **DANGER**

Do not allow that the shore power supply cable floats in the water. It may cause an electric field that may cause injuries or death of the surrounding swimmers.

#### **NOTE**

Disconnect the shore power supply when the system is not used.

#### **NOTE**

At least once a month check the status of the outer sheath.  
At least once a month check the status of the electric contacts and eventually protect them with proper products.  
At least once a month check the status of the shore socket and eventually clean it.



#### **DANGER**

Before carrying out any intervention on the electric system, disconnect all circuits (shore, generators, UPS/inverter):

- Disconnect the shore socket;
- Stopping the power generator and turn OFF the generator magneto-thermal;
- Disconnect the UPS and the possible inverter.

### 5.1.16 Main electrical panel

The main electrical panel allows distributing the electric current to the different on-board uses and appliances, through magneto-thermal switches and selectors located on the panel and, at the same time, monitoring the electric system by means of amperometers and voltmeters.

The closure of the contact of the black and grey water pumps are inhibited through two lead seals. There is no possibility to discharge black or gray water overboard.

The following main sections have been identified, in order to make the descriptions easier:

- A. 230V 50Hz magneto-thermal services battery breakers.
- B. Ammeters and voltmeters 230V line, generator control and power selector.
- C. Amperometers and voltmeter batteries, alarms light, black and grey water controls, and salt and fresh water autoclave pump controls.
- D. 24V magneto-thermal auxiliary services battery breakers.
- E. 24V magneto-thermal service battery breakers.

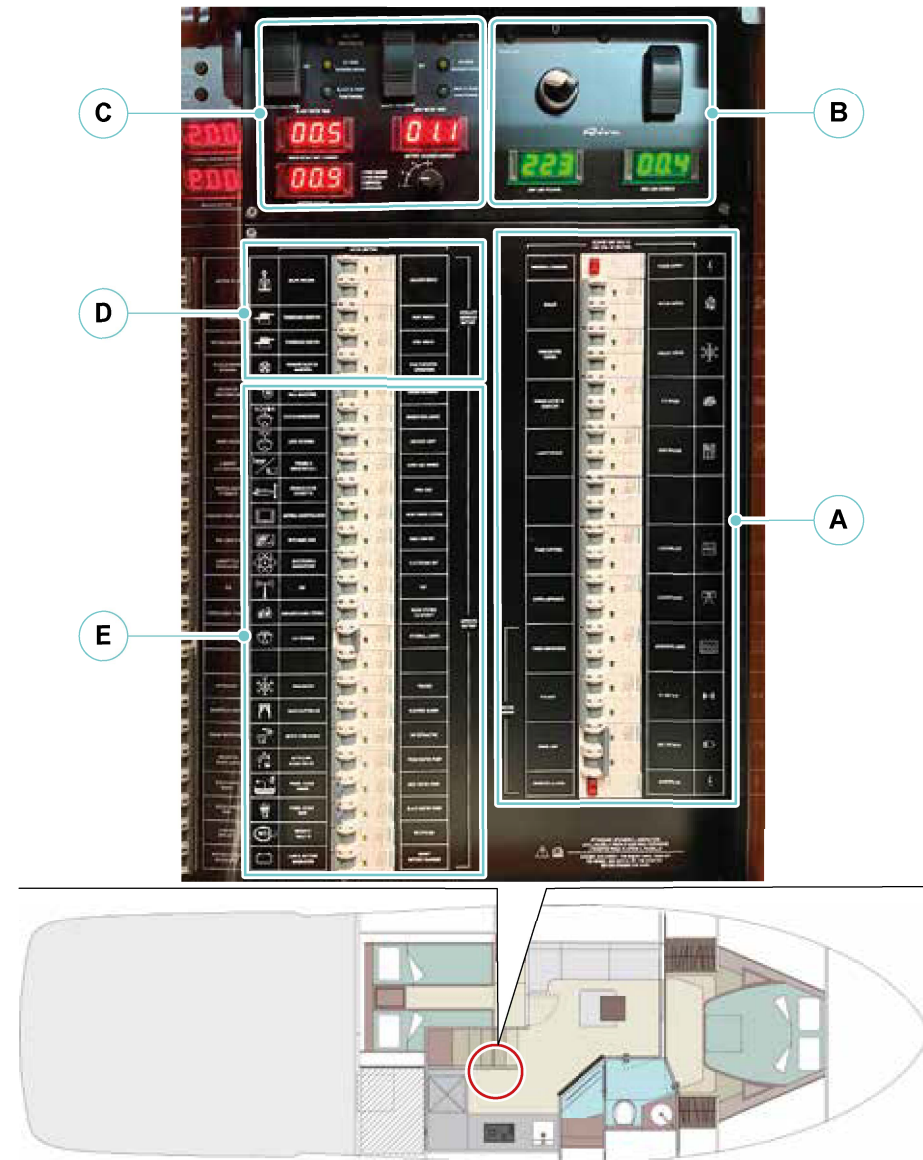

A 230V 50Hz magneto-thermal services battery breakers

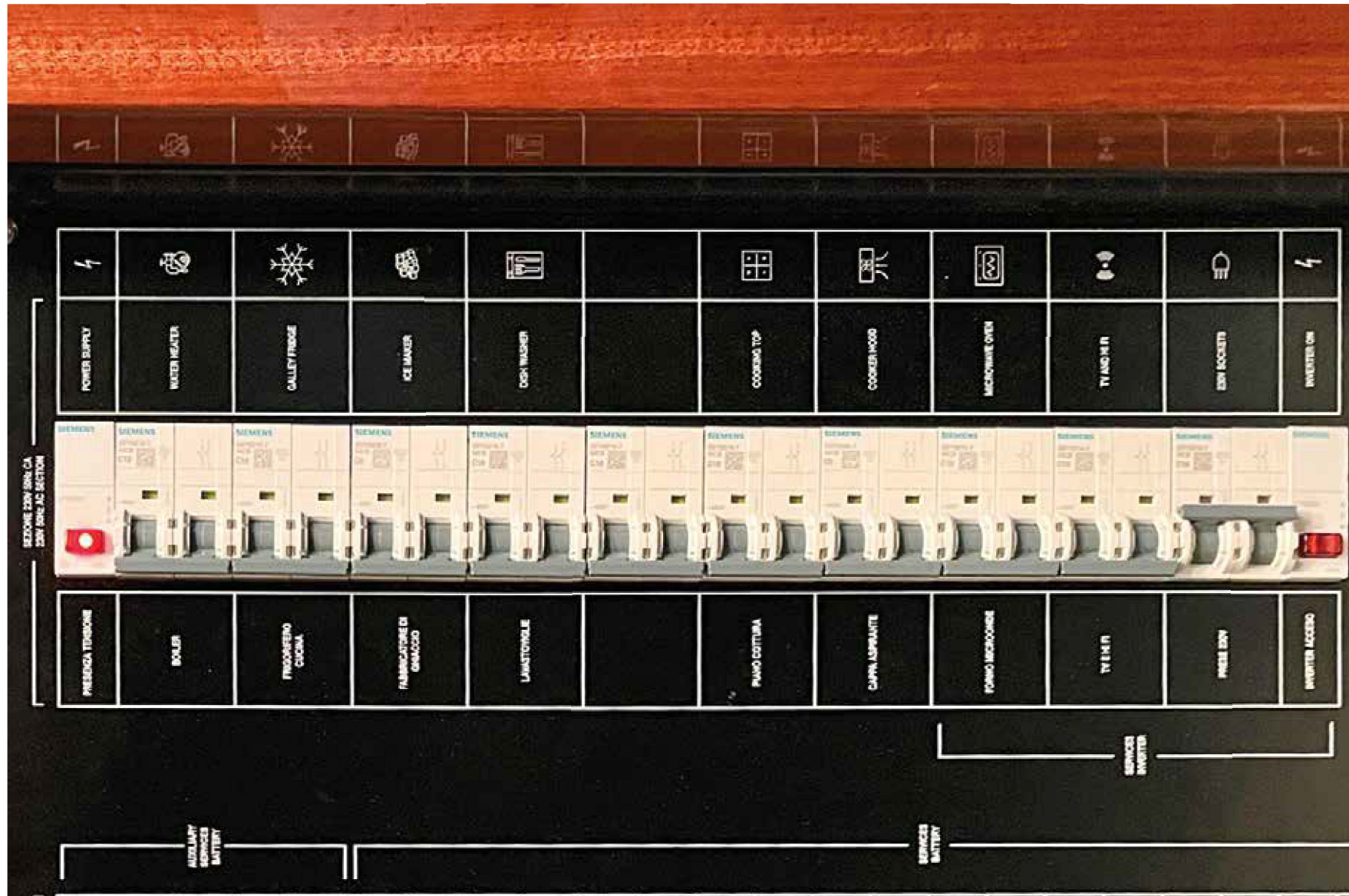

B Ammeters and voltmeters 230V line, generator control and power selector



C Amperometers and voltmeter batteries, alarms light, black and grey water controls, and salt and fresh water autoclave pump controls



D 24V magneto-thermal auxiliary services battery breakers

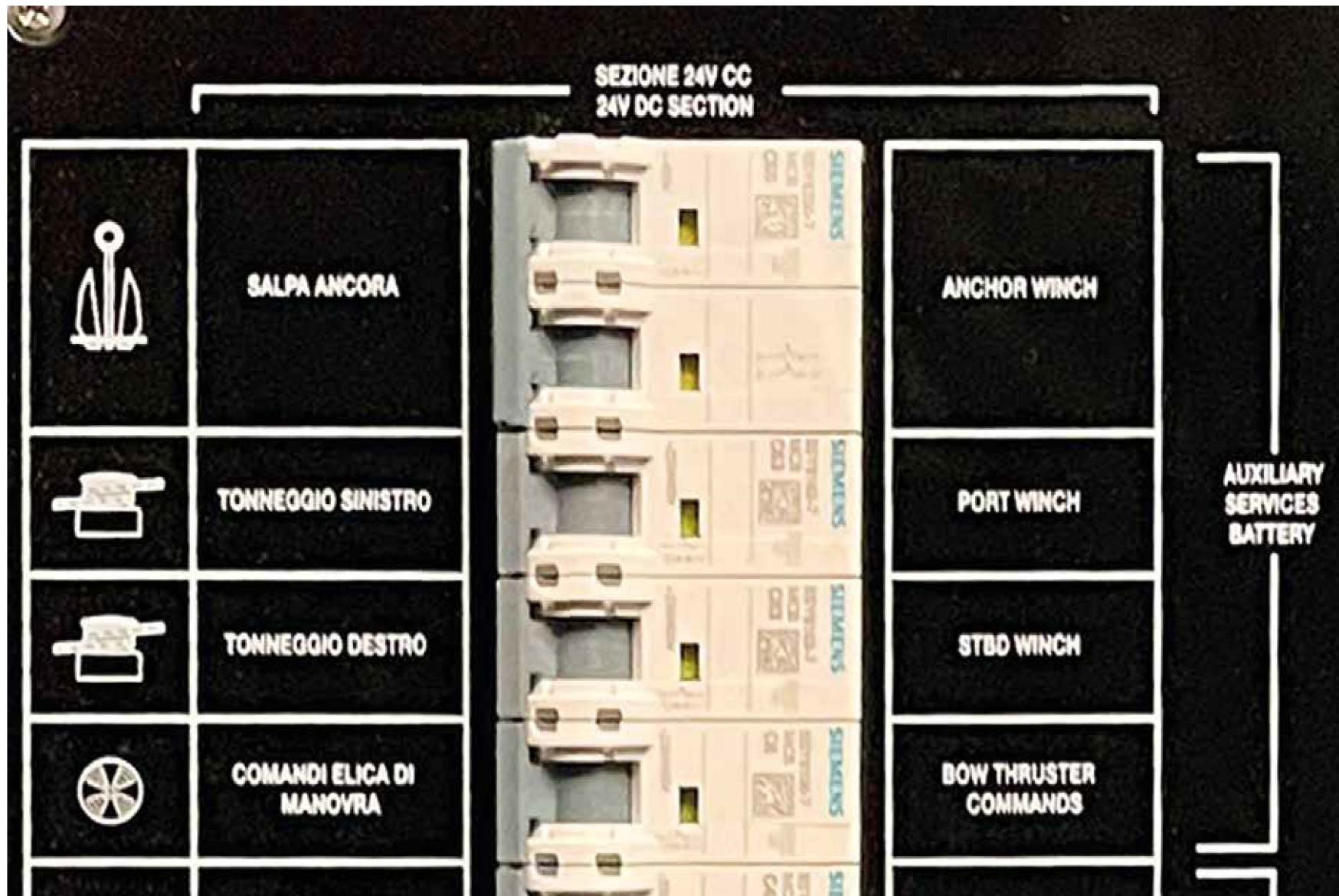

E 24V magneto-thermal service battery breakers

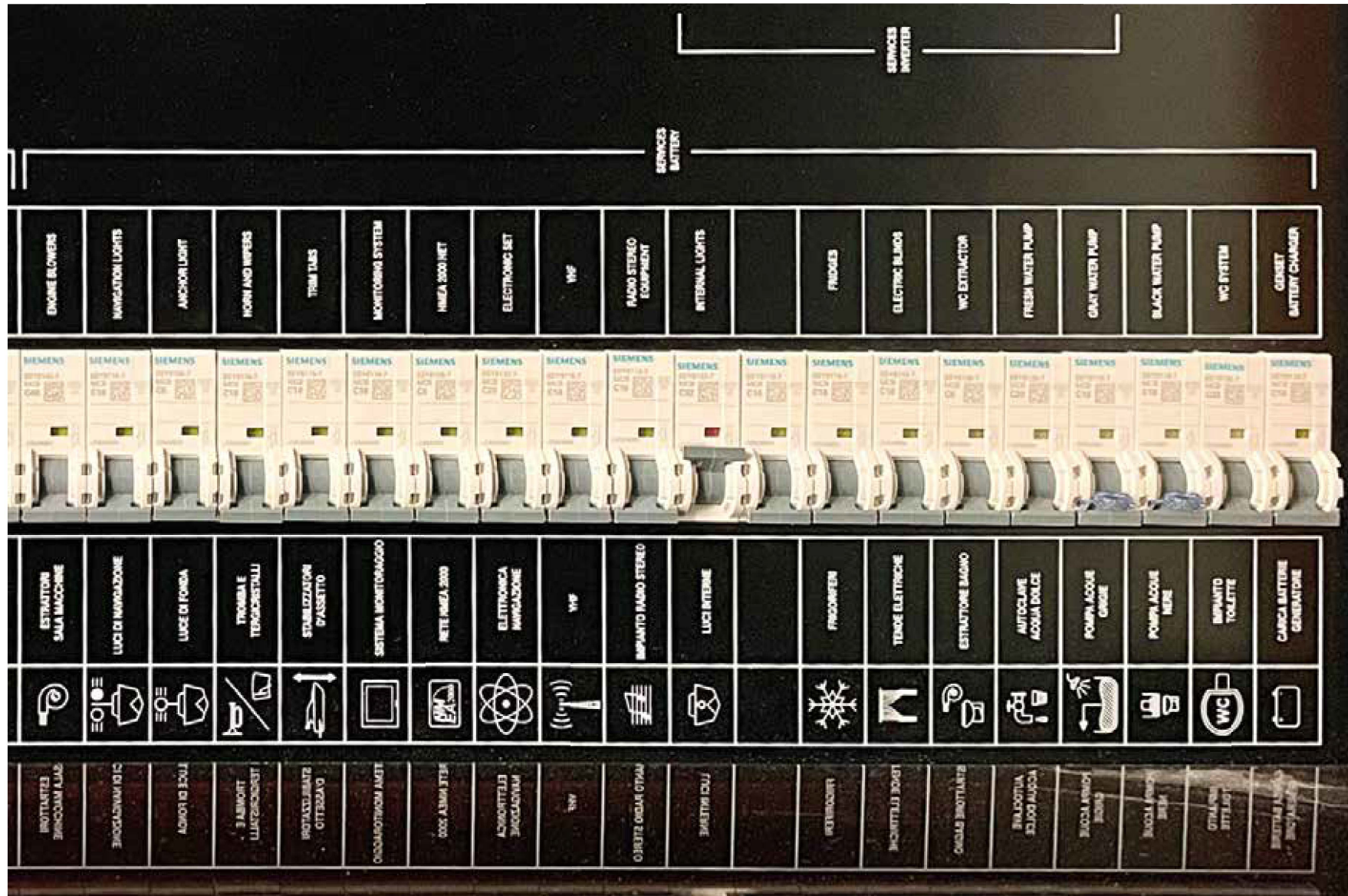

## 5.1.17 Engine room electrical panel

The following main sections have been identified, in order to make the descriptions easier:

- A. 24V safety system.
- B. 24V service from battery switch.
- C. 230V 50Hz magneto-thermal switch.

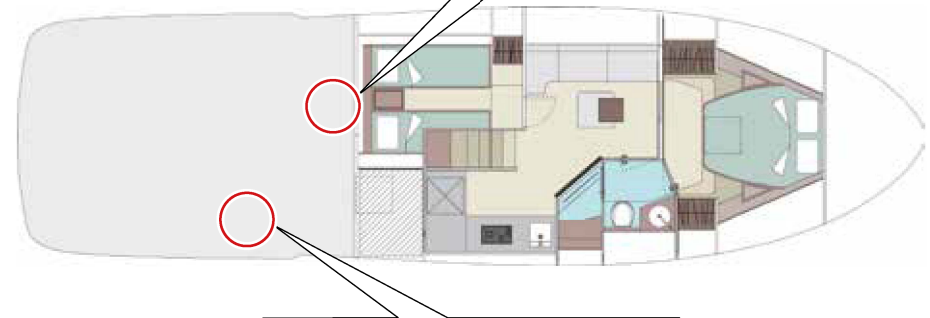
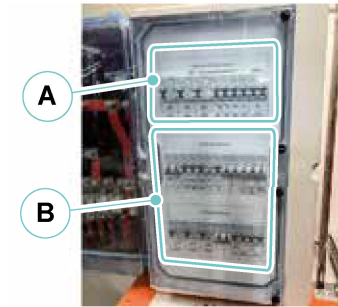

A 24V safety system



B 24V service from battery switch



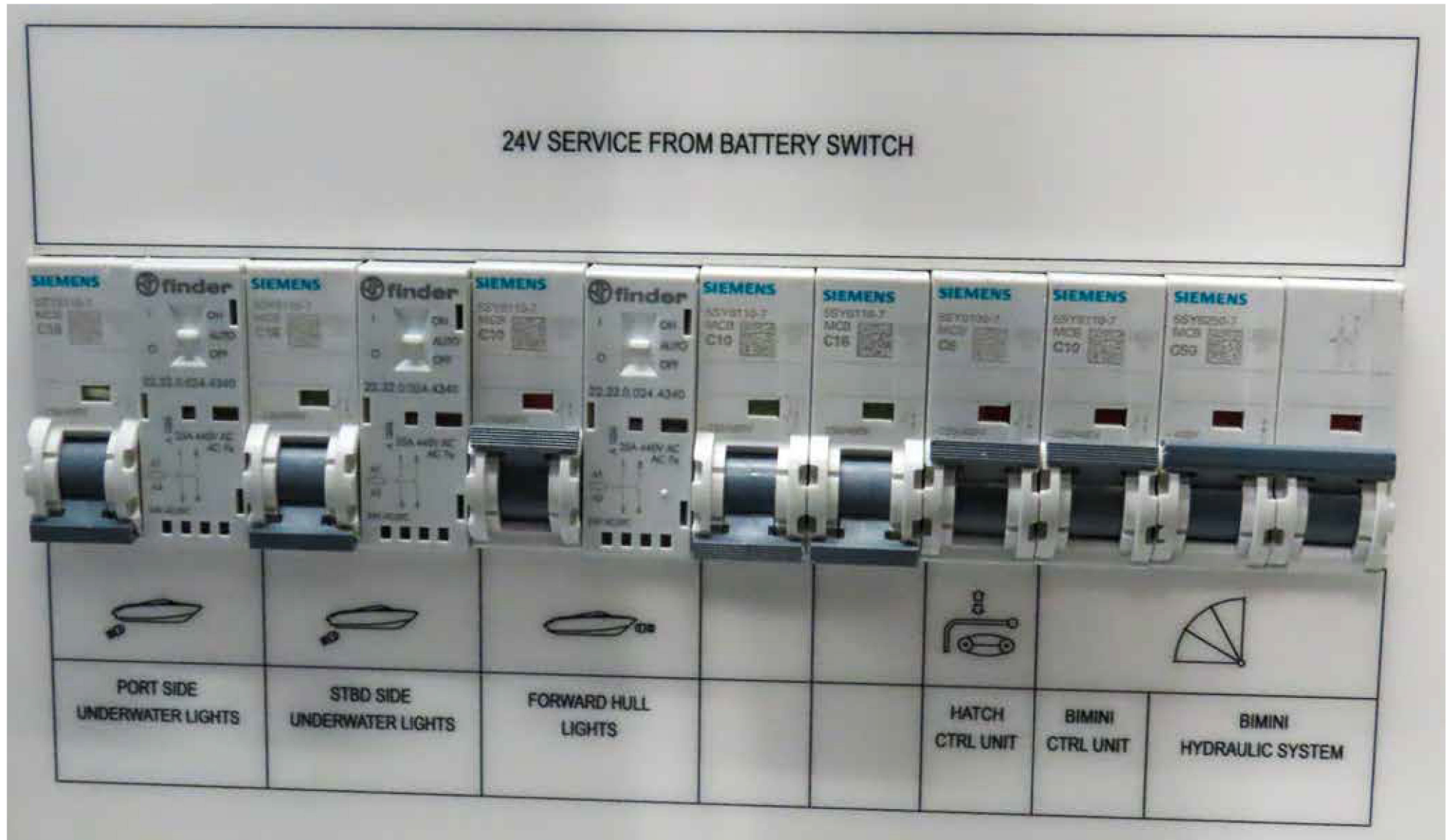

C 230V 50Hz magneto-thermal switch

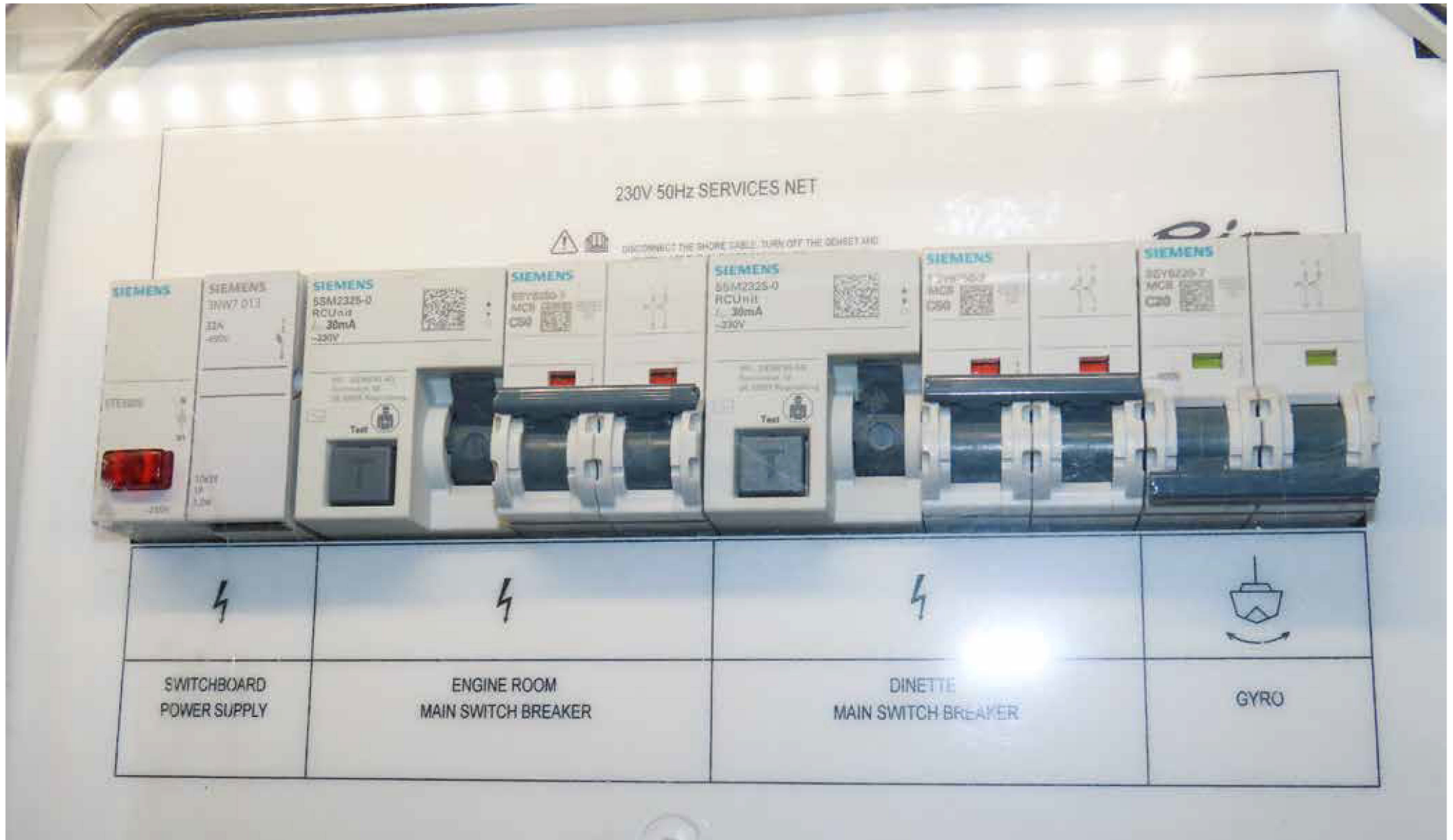



### 5.1.18 Generator set

Your yacht is equipped with a generator **(1)** (11 kW 50 Hz), operated by a diesel engine, dimensioned to satisfy the power supply requirements suitably planned in the electric balance for various navigation conditions.

The generator is situated astern the engine room on a base suitable to support its weight and vibrations.

The generator is contained in a sound-proof box, made of removable and insulating panels in painted marine aluminium. This solution allows easy access to the engine and to the alternator for maintenance and inspection, and at the same time a remarkable reduction of noise.

The starter generator is via its own independent 12V battery.

Near the generator is located the battery switch **(2)** that allows to connect or exclude the generator starter battery.

The generator is equipped with an electronic device for automatically recharging the start up battery by means of its own alternator.

The engine is cooled down, through a cupronickel heat exchanger, by sea water sucked through an independent sea water intake **(3)**, located forward of engine room and equipped with a cut-OFF valve and an inspectable strainer.

A second heat exchanger cools down the air inside a sound-proof box and the air necessary for the alternator ventilation.

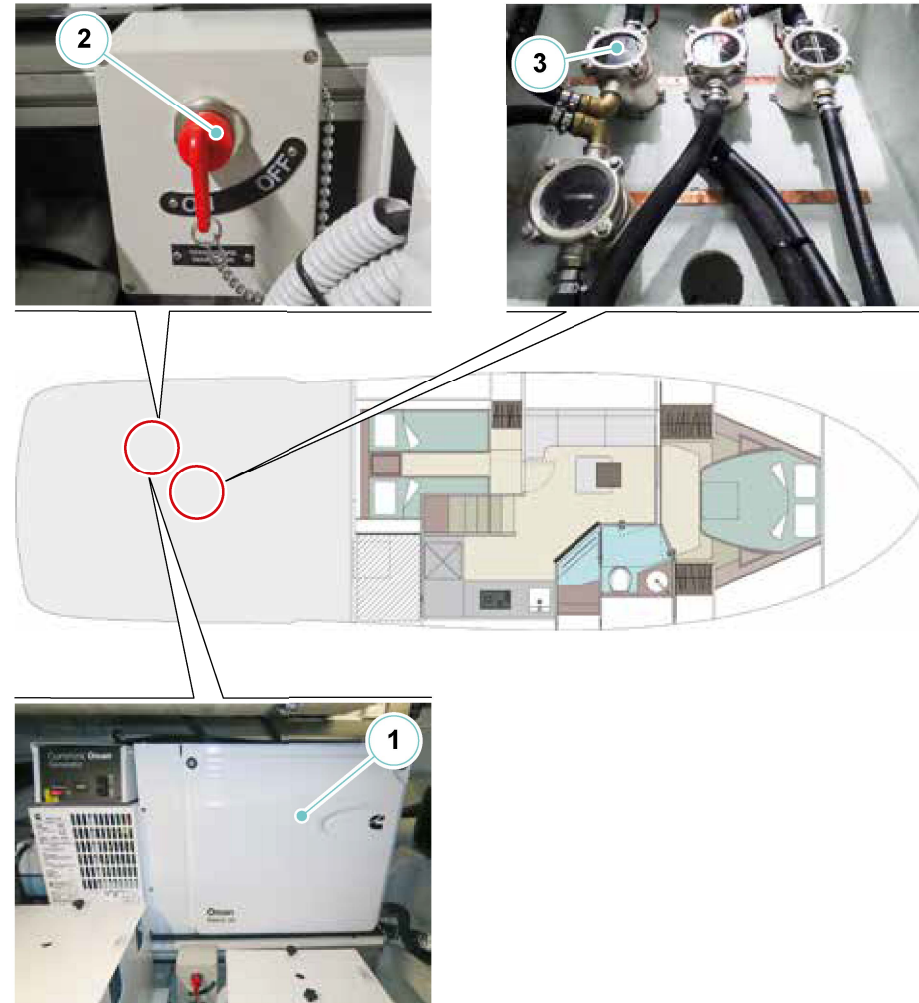

The inspectable sea inlet strainer effectively protects the cooling circuit from harmful ingress of mud, sand and algae.

The generator draws the air necessary for combustion directly from the engine room through an opening in the stand; exhaust gases are collected and silenced, through a special silencer and muffler and water/fume separator, located at the stern of the yacht. Besides exhaust gases, cooling water is discharged too. Immediately after the generator exhaust manifold there is the water injection point (raiser), where the mixture of cooling water and exhaust gas is formed.

The generator's muffler (4), besides reducing the noise, is used to collect water from the exhaust ducts, when the generator's engine is shut down, preventing water from entering the engine through the exhaust manifold.

The water/fume separator (5) divides the cooling water from the exhaust gas, discharging them overboards; it also further reduces the noise, already attenuated by the muffler.

The advantage of using this kind of exhaust is a considerable noise reduction, a lower grade of smoke of the exhaust and a reduction of the operating temperature.

The generator's start up battery can be recharged by the dedicated battery charger (optional) installed on the aft bulkhead of the engine room.

The charger can only recharge the battery when the yacht's power supply is connected to the shore.

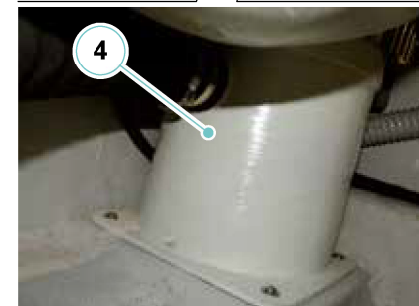

### NOTE

Carbon monoxide poisoning. Start the generator only in a well ventilated area. The carbon monoxide, generated by the inner combustion of engines, is extremely toxic.

Explosion/fire hazard. Check for the presence of fumes in the generator area.

### 5.1.19 Use of the generator

Before beginning with any start-up procedure, it is extremely important to become “familiar” with the generator set and its controls.

You will also have to carry out an inspection, in order to remove any kind of danger, real or potential.

We therefore recommend you to carefully read the instruction manual supplied by the Manufacturer and, at any rate, to follow indications given.

- Identify the position of the emergency stop buttons, switches and other emergency systems installed on the generator.
- Knowing the specific emergency procedures relevant to the installation in question.
- Check for the correct oil level by means of the relevant dipstick.
- Check that all electric uses are disconnected, to prevent starting the generator under load.
- Check that the water and fuel pipes are properly connected.
- Make sure that the sea water intake cut-OFF valve is completely open.

Start up the generator by pressing the START push-button located on the main electrical panel. Release the push-button only when the generator is running. Be careful not to exceed 15 seconds continuously per attempt. Allow a break of at least 30 seconds between attempts.

Carry out a new engine running-in cycle as stated by the engine manufacturer. Heat the set engine by running it idle for about 5 minutes after start up, in order to allow the lubricating oil to reach all parts of the engine.

Otherwise, excessive wear of the moving parts may occur. Stop the generator set pressing the STOP push-button located on the main electrical panel.



#### CAUTION

Repeated start-up attempts with negative result may cause an excessive build-up of water in the draining system, with possible serious consequences for the engine.



#### CAUTION

Before stopping the generator, it is recommended to let it run for a few minutes with no load, in order to allow the engine and the alternator to gradually cool down.



#### CAUTION

If the generator battery charger (optional) is fitted, it is advisable to switch it OFF before starting the generator.

### 5.1.20 Generator control panel

On the power generator there is a control panel allowing to carry out the controls and the start/stop operations.

A display indicates, generator status and any detected anomalies, thus allowing the monitoring of the power generator set.

Besides, the visualization of generator parameters is available on the helm position, in one of the monitoring system pages.



#### CAUTION

Before stopping the power generator, disconnect the various on-board uses supplied by it; stopping the power generator under load can irreparably damage the electronic control units of the various loads, beyond having a negative influence on the generator's operation.

However, please refer to the manual of the power generator to obtain more detailed information about the starting and stopping procedures.

#### NOTE

For further information on use and maintenance, please refer to the manufacturer's manual.



### 5.1.21 Inactivity periods

**CAUTION**

The correct procedures for reusing the generator after a period of inactivity are described in the documentation supplied by the Manufacturer.

Start the power generator at least once a month. If the power generator does not need to be used for a long time, it is necessary to proceed with the following operations:

- Change the engine oil.
- Replace the oil filter cartridge.
- Replace the fuel filter cartridge.
- Remove the injectors and insert 2 cc of engine oil into each cylinder, then let the engine run for several revolutions, manually operating on the pulley of the engine shaft. Then reinstall the injectors.
- Replace the sacrificial anodes.
- Disconnect the starting battery and place it in a dry location.
- Disconnect the sea exhaust pipe from the engine manifold.
- Clean the sea water strainer.
- Close the valve of the sea cock.
- Drain the cooling water from the muffler.

Generator exhaust system diagram

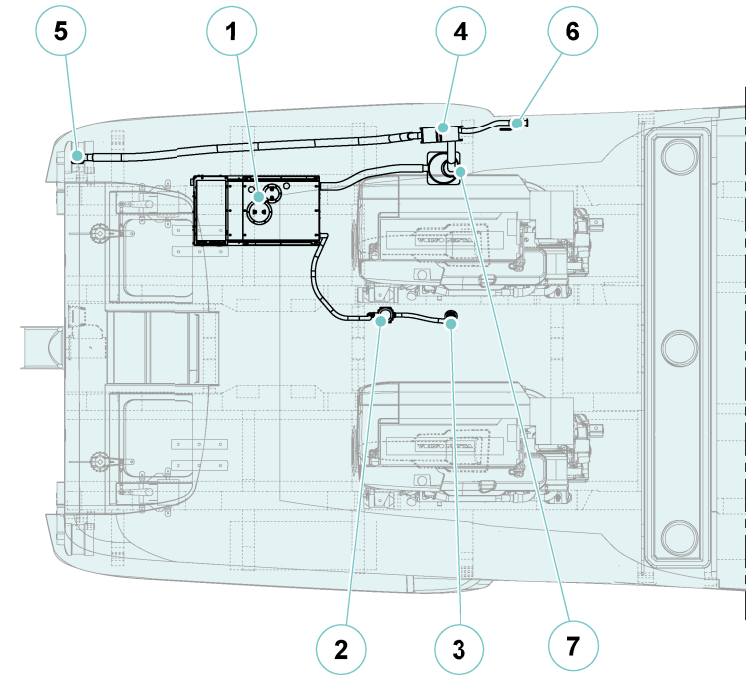
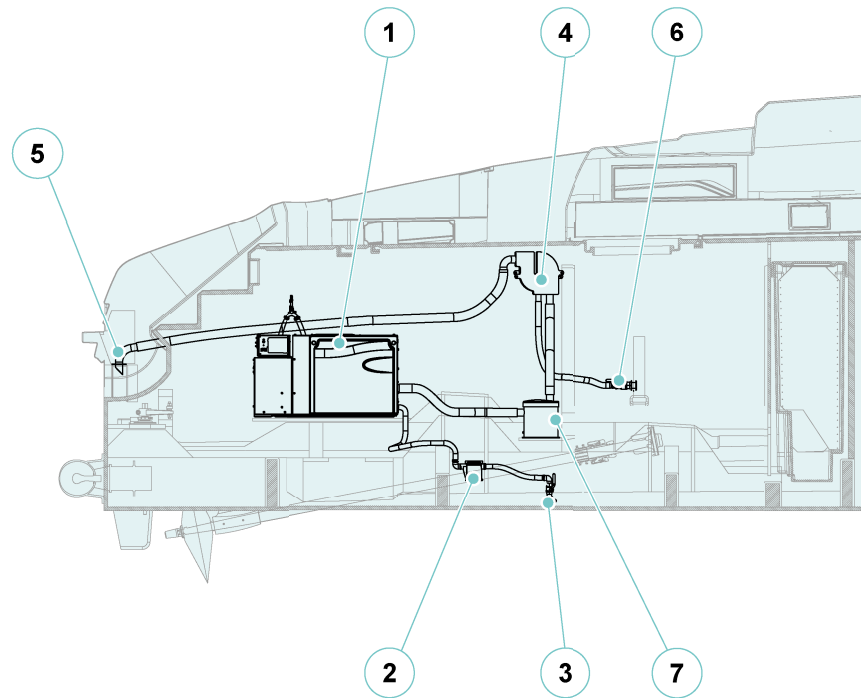

- 1. Generator
- 2. Generator seawater strainer
- 3. Generator seacock
- 4. Generator water-smoke separator

- 5. Generator smoke exhaust
- 6. Generator sea exhaust
- 7. Generator exhaust

5.1.22 Generator maintenance

Component	Maintenance	Notes and precautions
Lubrication system	Oil specifications	Use specified oils according to Manufacturer's indication.
	Oil check	Check the oil level in the stand daily or before each start-up to ensure that the level is in the safe range. Remove the dipstick and wipe the end clean, reinsert as far as possible, and remove. Maintain the oil level between the marks (Min and Max).
	Oil change	For the oil change remove the draining hose from its holder. Position the hose in the oil collecting container. Remove the oil filling plug. Open the oil draining valve located on the engine and drain the oil completely in the container. Change oil according to intervals suggested by the Manufacturer.
	Oil filter change	Remove the oil filter by turning it counter clockwise by means of a suitable wrench. Apply a thin layer of oil to the rubber seal of the new filter. Replace the oil filter according at time intervals recommended by the Manufacturer.
Fuel system	Cleaning and replacement of fuel pre-filter	Replace fuel pre-filter at time intervals recommended by the Manufacturer.
	Cleaning and replacement of fuel filter	Close the fuel supply valve. Loosen the fuel filter by turning it counter clockwise. Remove the filter and clean the contact surface. Tighten the filter on the adapter until the seal comes in contact. Replace fuel filter within the intervals indicated by the Manufacturer.

Component	Maintenance	Notes and precautions
Cooling system	Cleaning / replacement of the air cleaner	Release the two spring clamps and remove the cover of the air intake. Clean the cover and the base with a clean cloth so as to remove the dirt. Refit the filter and the cover at the base of the filter air intake. Replace the filter at time intervals recommended by the Manufacturer.
	Cooling liquid top up	Before filling the cooling system stop the generator and let it cool down. Close the draining taps. In order to discharge the pressure turn slowly the plug clockwise up to the first stop. Remove the plug after the pressure has been completely released.
	Sea water strainer	At least once a week check for the correct water flow through the filters. At least once a month check the integrity of the filters. At least once a month clean the suction filter. At least once every six months check the condition of the cover seal.



**ENVIRONMENT**

Recover all waste materials (engine oil, fuel, filter, etc..) according to the rules in force concerning the special waste disposal.

**NOTE**

Pay special attention to the coolant level. After the coolant drains, allow time when re-filling the coolant for a complete refill of the engine water jacket. Check the coolant level as prescribed in the Pre-start Checklist.



**DANGER**

Hot coolant and steams may cause heavy injuries or even death.

**NOTE**

Damage due to sea water. Sea water quickly deteriorates metals. Wipe up sea water on and around the generator set and remove salt deposits from metal surfaces.

**NOTE**

Failure to observe the oil specifications may cause inadequate lubrication/oil pressure and cold-starting difficulties.

**NOTE**

Do not add coolant if the engine is still hot. Adding coolant to an hot engine can cause the cylinder block or cylinder head to crack. Wait until the engine has cooled down.

**NOTE**

If the oil level is not positioned between the two reference notches do not activate any device.

## 5.1.23 Inspection and cleaning of the sea water intake strainer

The following operations must be carried out for sea water intake (1) strainer inspection and cleaning.

- Tightly close the sea water intake valve and then slowly open the strainer cover.
- Once the plug has been removed, remove the filter element; clean it with a brush and rinse it in water.
- Clean the strainer housing.
- Fill the strainer with water to avoid pumps from idle turning, thus damaging the system.
- Check and, if necessary, replace the gasket of the strainer cover.
- Re-position the strainer inside the box; close the strainer cover.
- Reopen the cut-OFF valve and check for leaks from the cover.



### CAUTION

Before restarting the generator, make sure that the cut-OFF valve is completely open.  
Before servicing the sea water line, disable the operation of the connected utility.



## 5.2 WATER SYSTEMS

### 5.2.1 Bilge system

The bilge system, made in accordance with ISO 15083, consists of 3 pump powered by 12V with a flow rate of 126 l/min, and 1 electropump powered by 12V with a flow rate of 35 l/min, installed in a suitable position for the proper draining of bilges and so placed:

- **Engine room (n°2);**
- **Mid yacht (n°1).**

The suctions of the pumps are equipped with plastic net strainers, whose purpose is to prevent the penetration inside the circuit of foreign bodies, which may damage the pump or cause pipe clogging.

The water sucked from the bilges is sent to the overboard drains located on the yacht's sides. The bilge pumps are directly connected to a battery, and thus guarantee bilge drain at any time.

Therefore, it is not necessary to activate the service battery breaker. In order to make them work, it is necessary to activate the relevant magneto-thermal located on the secondary electrical panel in the Technical room.

It is possible to evacuate the water from the bilges where the pumps are located either in automatic or manual mode. The pumps' activation, in automatic mode, is controlled by floater switches (1) installed in the bilge, which activate the pumps when they detect a too high level of waters. In order to manually start the pumps, press the relevant spring push-buttons located on the helm position, making sure that the magneto-thermal switches are connected. The upper floats (2), in the bow and stern areas of the engine room, control the activation of the "Acquallarm" alarm siren which, in the event of flooding, signals a high water level in the bilge. The submersible bilge pumps are connected directly to the service batteries and can therefore be activated even when the battery master switch is set to OFF, thus ensuring water evacuation even when the yacht is unattended, with magneto-thermals in the secondary electrical panel switched on.

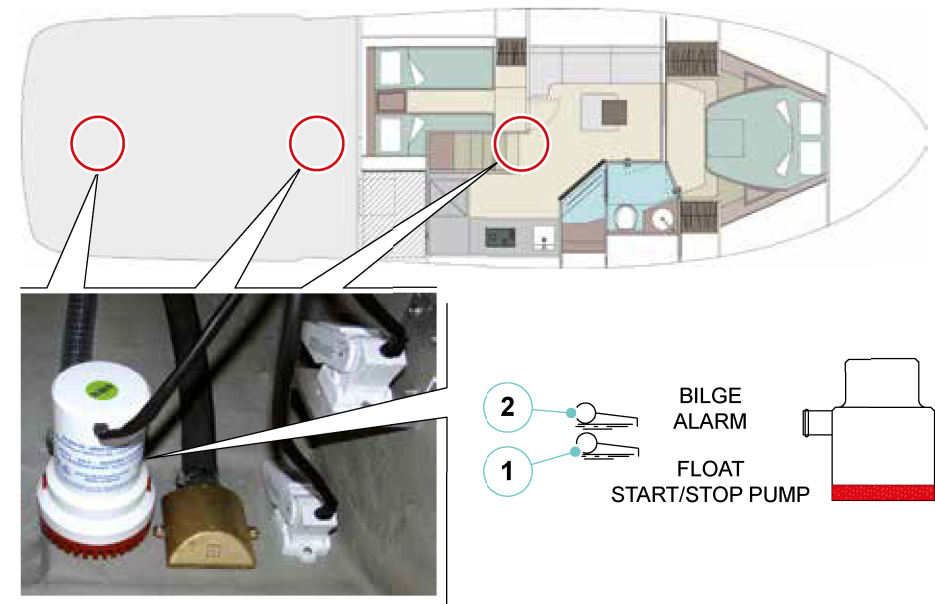

The bilge high water level alarm siren, located in the helm position, is directly connected to the service batteries: therefore, for its operation, it is necessary to activate the special magneto-thermal switch located on the engine room secondary electrical panel.



### CAUTION

The system total capacity is not designed for yacht draining in case of leaks.

### NOTE

In case of leaks in the engine room, it is possible to suck huge quantities of water from the engine room bilge through the cooling system pumps of each engine.



### ENVIRONMENT

Any oil or fuel in the bilge must be collected and stowed. It is forbidden to discharge bilge water mixed with oil or fuel into the sea, because this causes serious pollution. During maintenance operations in the engine room, it is compulsory to disconnect the magneto-thermal switches of the bilge pumps' automatic suction system, thus preventing the accidental spillage of liquids and, consequently, sea water pollution.



### CAUTION









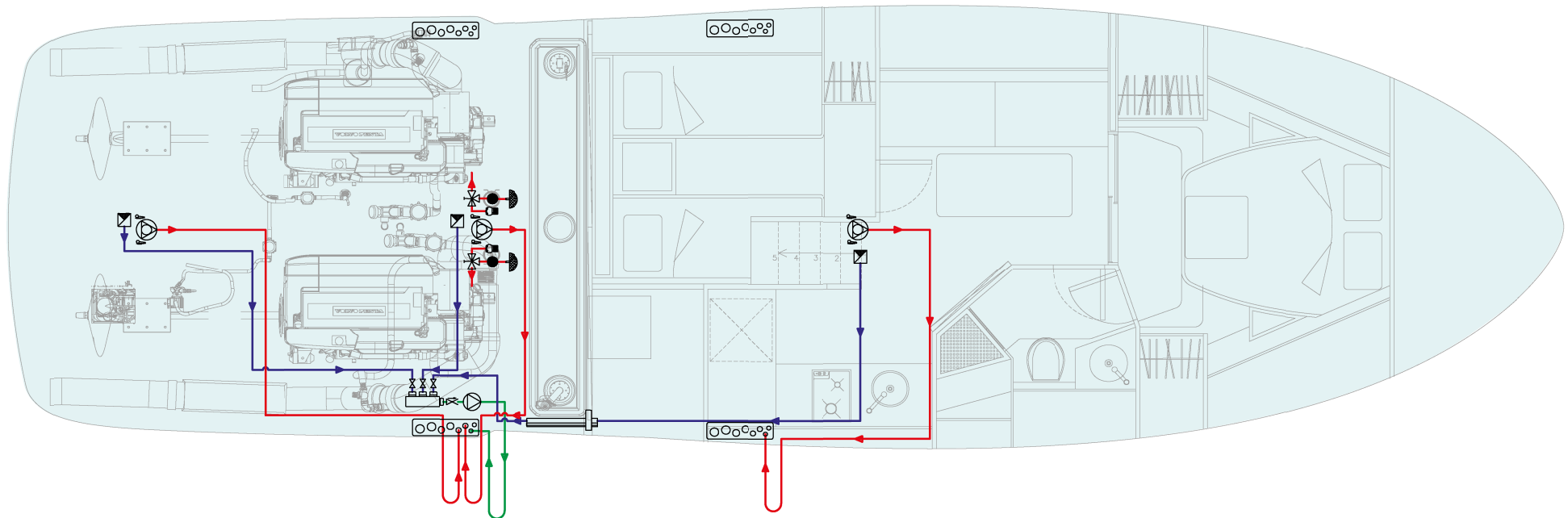



Avoid leaving rags or other residues which could clog the suction inlets of the pumps, thus causing serious damage to them, even though the inlets are protected by filtering nets.



### CAUTION

Check all bilge pump operation at regular intervals. Clean the pump intakes. The hull valves installed in the bow and stern peak walls must be held closed; they must be open only to drain the water from the main bilge.



- |   |                        |   |                                    |   |                              |
|---|------------------------|---|------------------------------------|---|------------------------------|
|  | Centralized discharge  |  | Bilge pump                         |  | Safety double intake valve   |
|  | No return foot valve   |  | Bilge alarm/starting sensor        |  | Rubber gasket foot valve     |
|  | Multi purpose manifold |  | Stainless steel bulkhead connectop |  | Bilge line                   |
|  | Bilge electropump 24V  |  | Ball valve                         |  | Auxiliary bilge suction line |
|   |                        |   |                                    |  | Auxiliary bilge supply line  |

**5.2.2 Bilge system maintenance**

Component	Maintenance	Notes e precautions
Bilge pumps	Operation check	<p>Check for the correct operation of the bilge pumps before each navigation.</p> <p>At least every month, check the status and the function of all installed bilge pumps as well as of the related overboard discharge.</p> <p>Pay special attention to not leave any rags or other residue in the bilge, as these may plug the pump intakes, damaging them.</p>
Bilge	Inspection and cleaning	<p>When using detergents or solvents, remember to adequately ventilate the spaces.</p> <p>Protect breathing and the eyes by using a suitable mask, and protect your hands with gloves, when using detergents.</p>
Autoclave pump	Cleaning	Check the cleanliness of the pump suction protection grids

### 5.2.3 Bilge pump operation check

This kind of electric pump does not usually need ordinary maintenance, as long as some precautions are taken to extend their good operation.

- Where a freezing danger exists, it is necessary to completely drain the bilge.
- Although the immersion pumps are designed to also work dry, it is advisable to run them under this condition as little as possible.
- Regularly check the efficiency and cleanliness of the different protection filters.
- If the yacht is to be inoperative for a long period, it is advisable to drain the pump body and clean it (for proper procedures, contact the pump Manufacturer).
- Check if the impeller is jammed, this should never occur because it could cause heavy damage to the electric engine; if necessary carry out impeller and pump body descaling by means of proper detergents (contact the pump manufacturer).



#### DANGER

Before carrying out any maintenance operation, disconnect the magneto-thermal switches in the engine room so that accidental activation is prevented.

#### NOTE

Once the checks on the bilge pumps have been completed, check that the relevant magneto-thermal switches are active again.

The operations to check the functionality of the bilge pumps are as follows:

- Check the operation of each bilge pump at least once a month, filling the bilge with clean water up to the activation of each pump and checking proper overboard pumping;
- Check the operation of each bilge pump: in manual mode, by means of the relevant push-buttons located on the synoptic panel of the main electrical panel in the helm position, or from the secondary electrical panel in the engine room; In automatic mode, by manually lifting the float switches.



#### CAUTION

Pump and component replacement must be carried out by specialized personnel, using only original spare parts.



#### ENVIRONMENT

The float switches activating the bilge pumps and the alarm siren for "High water level in the bilge" contain mercury, a substance which may cause pollution. Dispose of pursuant to the laws in force.

### 5.2.4 Fresh water system

Water supplying the fresh water system of your yacht is contained in a 310 litres (82 gals) tank placed underneath the bed in crew cabin.

The tank is filled via a gravity filling nozzle (1) near the cockpit.

The fresh water filler opening cap is fastened to the structure by means of a steel cable to prevent it from getting lost or falling overboard. The tank is equipped with an air vent and electronic level switch that transmits the indications of level to the apposite helm position instrument.

The system can be supplied by a shore-side water connection (2) (stern starboard peak) on which line is a pressure reducing valve in engine room.

From the tank, the fresh water is sucked by the autoclave pump (3), located in the engine room, through a special suction pipe

The fresh water pump, protected and supplied by the magneto-thermal switch located on the electrical panel in the engine room, 24V uses section, guarantees the continuous presence of fresh water in the system by a check valve.

In case of technical problems, see instruction manual of the pumps group or contact RIVA After Sales & Service Department.

When the yacht is left unused, for long periods of inactivity or winter storage, we recommend keeping a concentrated quantity of disinfectant inside the tank, and then to drain the tank by opening all uses. This will enable a disinfection of the whole system, preventing the formation of bacteria in the system.

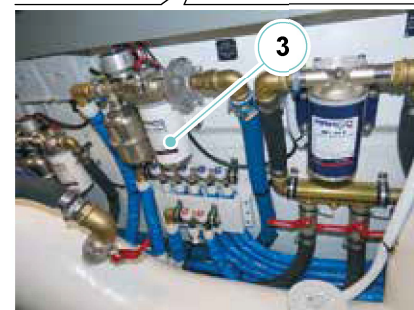
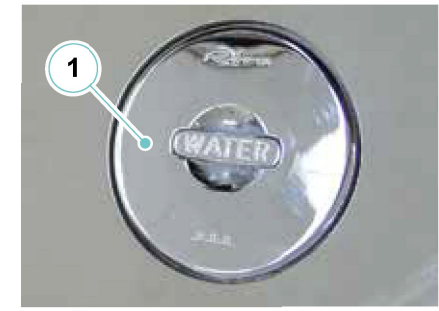

**CAUTION**

We recommend taking care of the tank's hygiene, by pouring a disinfectant solution every two fillings.

The filling nozzle cap is marked 'WATER' to prevent the accidental intrusion of different liquids. To avoid damage to the system and tanks, we recommend filling by gravity and not by pressure.

**5.2.5 Cold water system**

The autoclave pump picks up cold water from the fresh water tank and supplies it to the following uses:

- Shower in the stern starboard peak;
- Bathroom services;
- Galley;
- Water heater;
- WC system;
- Deck washing hose;
- Ice maker;
- Cockpit washbasin;
- Screen wiper.

If the yacht is moored in a marina that includes running water service, the equipment can be supplied without using the yacht's autoclave by means of the pressure from the shore system.

The connection with the running water system from the shore is made via the water intake situated in the stern starboard peak.

A pressure reducer, located in the engine room, protects the yacht's water system against harmful pressure variations.

The fresh cold water reaches all utilities through the distribution manifolds, provided with check valves in order to enable the sectioning of the system in case of failure or maintenance. The distribution manifolds are located underneath the saloon limber boards and starboard of the engine room.



## CAUTION

Regularly inspect the fresh water and bilge circuits for leaks. Repair any leaks by releasing the pressure in the system, in order to avoid damaging the furniture and the electrical equipment. The fresh water circuit, and particularly the tank, must be sanitized periodically by pouring a specific disinfectant solution into the filler.

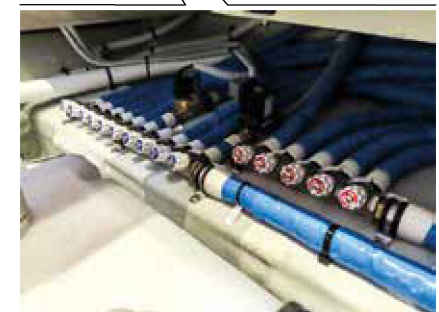
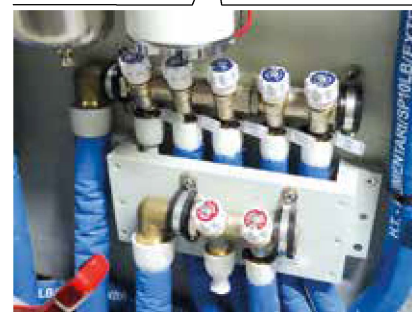

### 5.2.6 Hot water system

The autoclave pump draws cold water from the fresh water tank and sends it to the electric water heater located underneath the saloon limber boards.

The water inside the water heater is heated and then reaches the following utilities:

- Shower in the stern starboard peak;
- Bathroom services;
- Galley;
- Cockpit washbasin.

The fresh cold water reaches all uses through the distribution manifolds, provided with check valves in order to enable the sectioning of the system in case of failure or maintenance.

The water heater (1) is supplied at 230V delivered either by the generator or by the shore power supply; in order to activate the water heater, operate the magneto-thermal switch located on the main electrical panel.

The water heater's inlet and outlet water ducts are equipped with ball cutoff valves. The inlet duct is provided with a check valve which prevents hot water backflow inside the circuit.

This valve shall be checked and replaced according to the indications given by the manufacturer.

The easily accessible distribution manifolds are located in the engine room and underneath the limber boards close to the saloon.

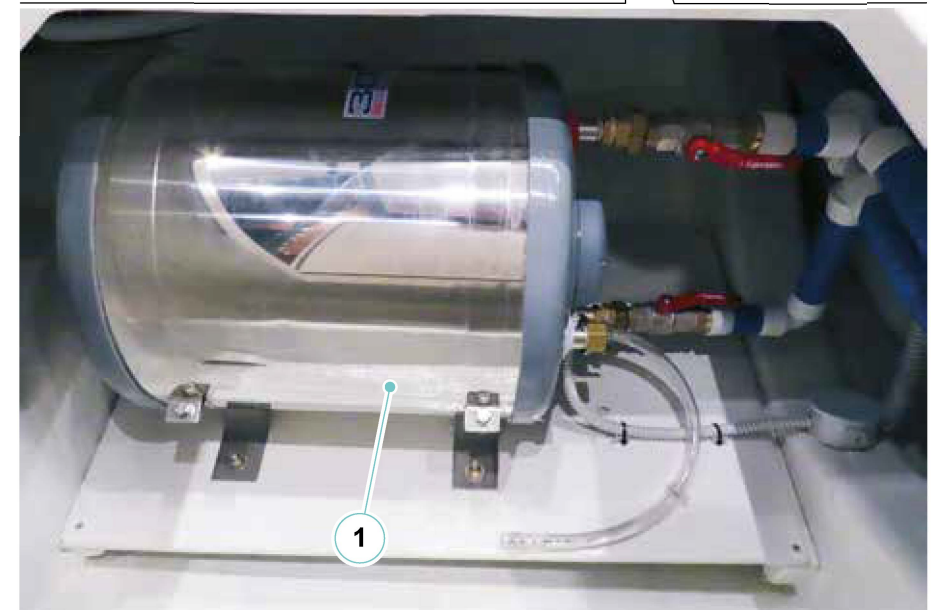

**NOTE**









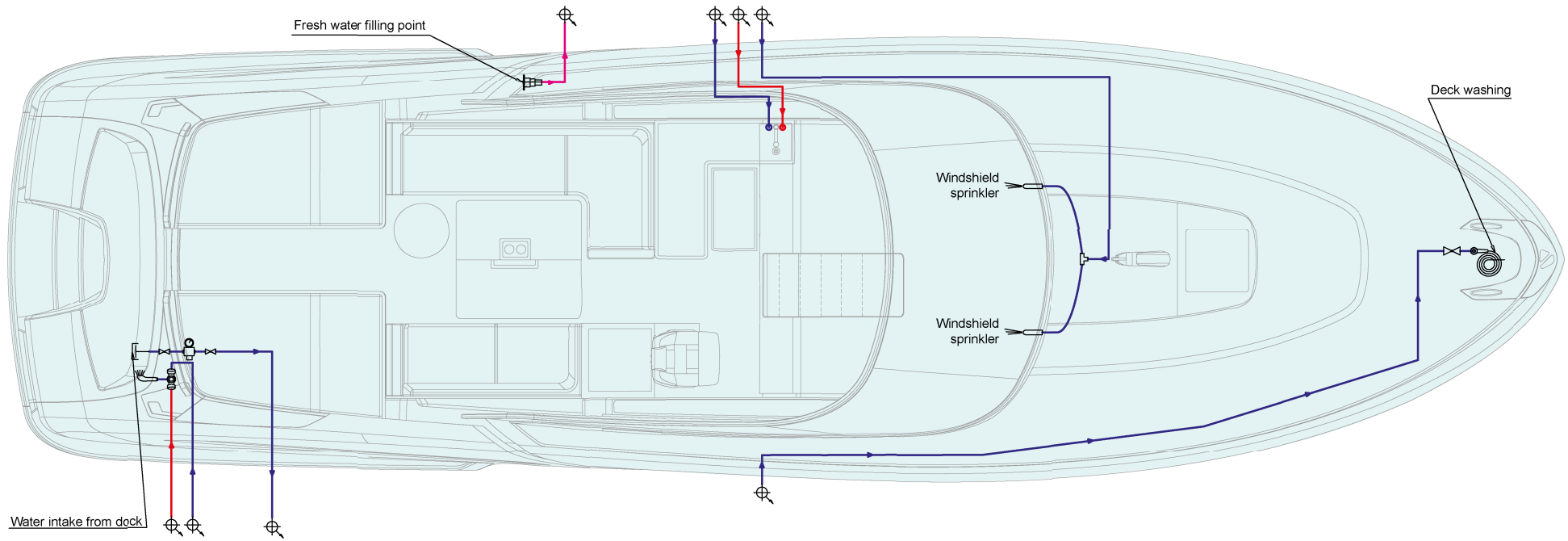





















The water heater is not an accumulator: wait that goes up to temperature.

**NOTE**









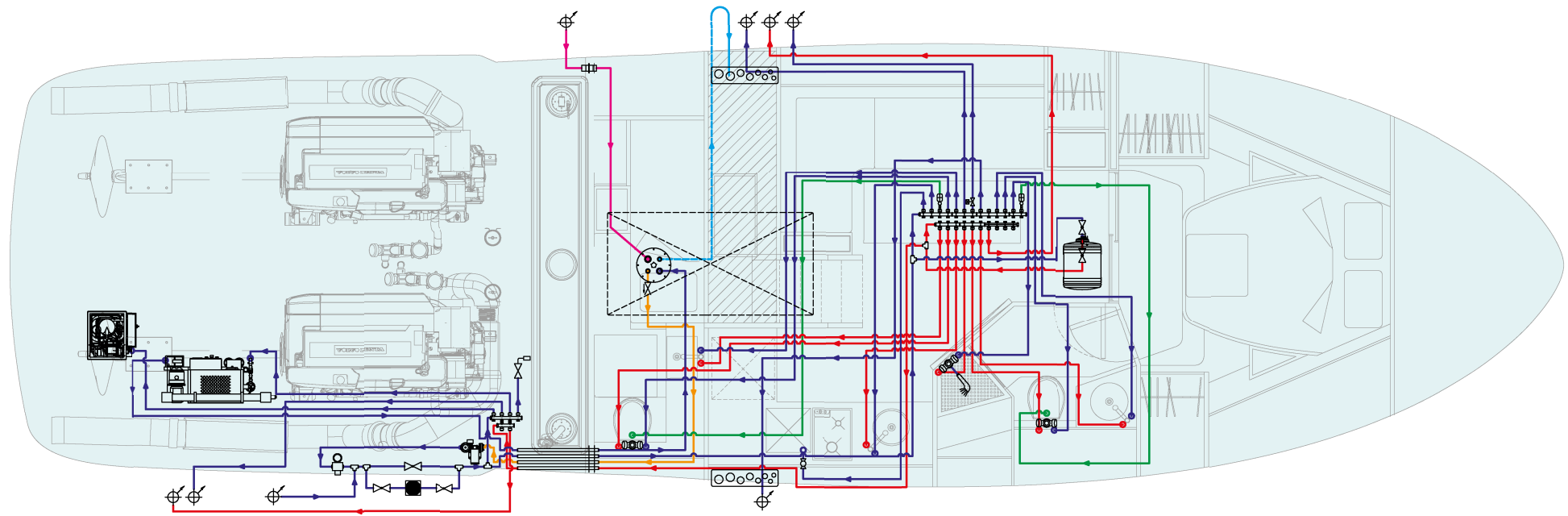





















For further information on use and maintenance, please refer to the manufacturer's manual.

## Fresh water system diagram



- |   |                             |   |                                    |   |                               |
|---|-----------------------------|---|------------------------------------|---|-------------------------------|
|  | Water heater                |  | Manifold 2W with valve             |  | Going up pipe                 |
|  | Filter                      |  | Manifold 3W with valve             |  | Going down pipe               |
|  | Windshield sprinkler        |  | Fresh water intake cap             |  | Tee                           |
|  | Sink                        |  | Ball valve                         |  | Dishwasher tap                |
|  | Hose basin                  |  | Non-return valve                   |  | Centralized discharge         |
|  | Shower group                |  | Stainless steel bulkhead connector |  | Warm fresh water system line  |
|  | Pressure reducing valve     |  | 24V fresh water pump               |  | Hot fresh water system line   |
|  | 24V solenoid valve + filter |  | Deck washing                       |  | WC fresh water line           |
|  | Windshield electrovalve     |  | Watermaker                         |  | Air vent line                 |
|  | Manifold 4W with valve      |  | Chiller unit                       |  | Fresh water tank filling line |
|   |                             |   |                                    |  | Fresh water suction line      |



- |   |                             |   |                                    |   |                               |
|---|-----------------------------|---|------------------------------------|---|-------------------------------|
|   | Water heater                |   | Manifold 2W with valve             |   | Going up pipe                 |
|  | Filter                      |  | Manifold 3W with valve             |  | Going down pipe               |
|  | Windshield sprinkler        |  | Fresh water intake cap             |  | Tee                           |
|  | Sink                        |  | Ball valve                         |  | Dishwasher tap                |
|  | Hose basin                  |  | Non-return valve                   |  | Centralized discharge         |
|  | Shower group                |  | Stainless steel bulkhead connector |  | Warm fresh water system line  |
|  | Pressure reducing valve     |  | 24V fresh water pump               |  | Hot fresh water system line   |
|  | 24V solenoid valve + filter |  | Deck washing                       |  | WC fresh water line           |
|  | Windshield electrovalve     |  | Watermaker                         |  | Air vent line                 |
|  | Manifold 4W with valve      |  | Chiller unit                       |  | Fresh water tank filling line |
|   |                             |   |                                    |  | Fresh water suction line      |

**5.2.7 Fresh water system maintenance**

Component	Maintenance	Notes e precautions
Fresh water tank	Inspection and cleaning	<p>At least every month, drain the fresh water tank completely and rinse it a couple of times with clean fresh water. This in order to completely change the water stored and at the same time to wash the tank too.</p> <p>Periodically pour a specific disinfectant, in the quantity recommended by the Manufacturer, into the tank, through the intake filler, in order to prevent the formation of bacteria in the system.</p>
Autoclave pump	Inspection	<p>Regularly check for leaks.</p> <p>Before carrying out any operation on the pump, prevent its accidental activation.</p> <p>Check daily that the expansion tank located downstream the electric pump shows the correct pressure in the air cushion. The correct tank pressure must be within a range of 1.2 bar min and 2.4 bar max.</p>
Fresh water system	Inspection	<p>In case of need or of maintenance, by acting on the valves installed on the distribution manifolds, it is possible to cut out parts of the system or single services, without involving the operation of the general system.</p> <p>Check if along the hydraulic circuit, where possible, are present leaks due to the damage of piping.</p>
Water heater	Inspection and cleaning	To obtain a good performance from the system, it is advisable to descale the resistor about every two years, according to the indications given by the Manufacturer.
	Descaling the resistor	To obtain a good performance from the system, it is advisable to descale the resistor about every two years, according to the indications given by the Manufacturer.
	Magnesium anode	Replace the possible magnesium anode every two years, according to the indications given.

### 5.2.8 Air bleeding

If the water tank empties, the fresh water circuit pump permanently starts, sucking air.

In this case, it must be switched off immediately from the control panel, in order to prevent the pump from burning out due to prolonged empty operation. In the situation of an almost empty tank, it is advisable to deactivate the autoclave beforehand.

This situation is signalled by the noise of the pump, that continuously runs even if the taps are closed. In this case, bleed the air proceeding as follows:

1. Disable the pump from the electrical panel
2. Fill the tank
3. Open a tap
4. Activate the pump from the electrical panel
5. Let the water flow until the air has escaped
6. Close the tap
7. Make sure that the pump has reached the operating pressure and that it does not restart.

#### NOTE

The fresh water pump is self-priming but, to operate, it needs that its body is filled with liquid.

For a correct use, we recommend at first priming or after a long idling period, to fill the pump body with liquid, to check the pressure inside the tank (it must have the same value of the min. pressure indicated by the pressure switch) and to verify the clockwise rotation of the pump (seen from the engine side).

Besides, if on the main electrical panel the pump operating led always remains lit, but the slaved services are not being used, check if the pump body is empty.

When the yacht is not operated for long periods of time the pump should be drained by means of relevant magneto-thermal switch.

Component	Maintenance	Notes e precautions
Autoclave pump	Inspection and cleaning	<p>Regularly check that fittings are tightly closed and free from corrosion. Check the conditions and the cleanliness of the pump and of the expansion tank; if necessary, clean with well diluted detergent and dry accurately (see specific Manual).</p> <p>Replace the impeller, the mechanical seal, the tank membrane and engine brushes of the pump according to the manufacturer's instructions and frequency.</p>

### 5.2.9 Grey water system

Grey drainage waters are collected inside the tank (2) located in the middle of the yacht, which has a capacity of 120 liters (32 gal). The tank collects the discharge water from sinks, showers and the condense water of the air conditioning system fan-coil. The tank, not being airtight, does not need any air vent.

The immersion pump located inside the tank discharges the outboard water through the discharge located in the engine room on the starboard side. The pump power magneto-thermal (3) is located on the main electrical panel, 24V section, locked with lead to inhibit it's operation.

The pump is automatically controlled by an electronic level switch installed inside the tank. The grey water pump starts when the sensor detects a high water level and deactivates once the water level has lowered.

The system is equipped with a timer which delays useless pump start ups due to yacht's roll.

Besides, to make picking up of grey water easier in the tank, there are two holding tanks (1) with dedicated pump situated underneath a limber board in the saloon.

The system is equipped with solenoid valves that shut off the taps if the collection box is full.

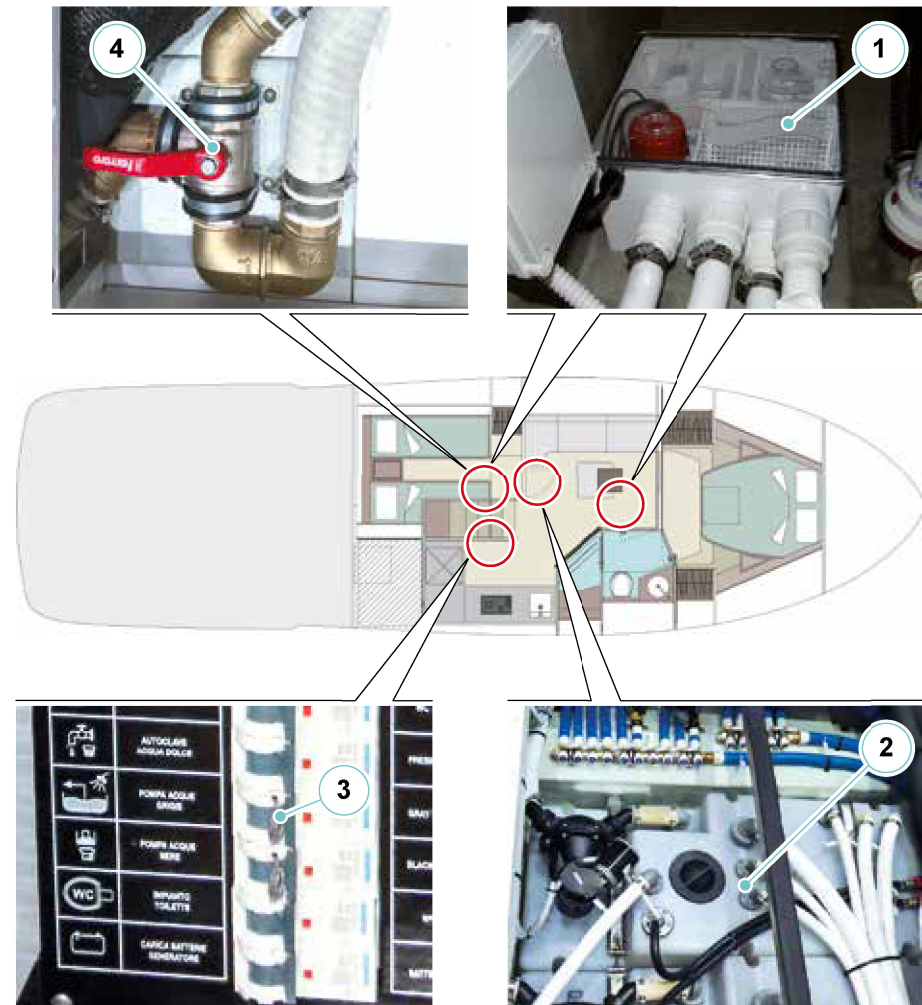







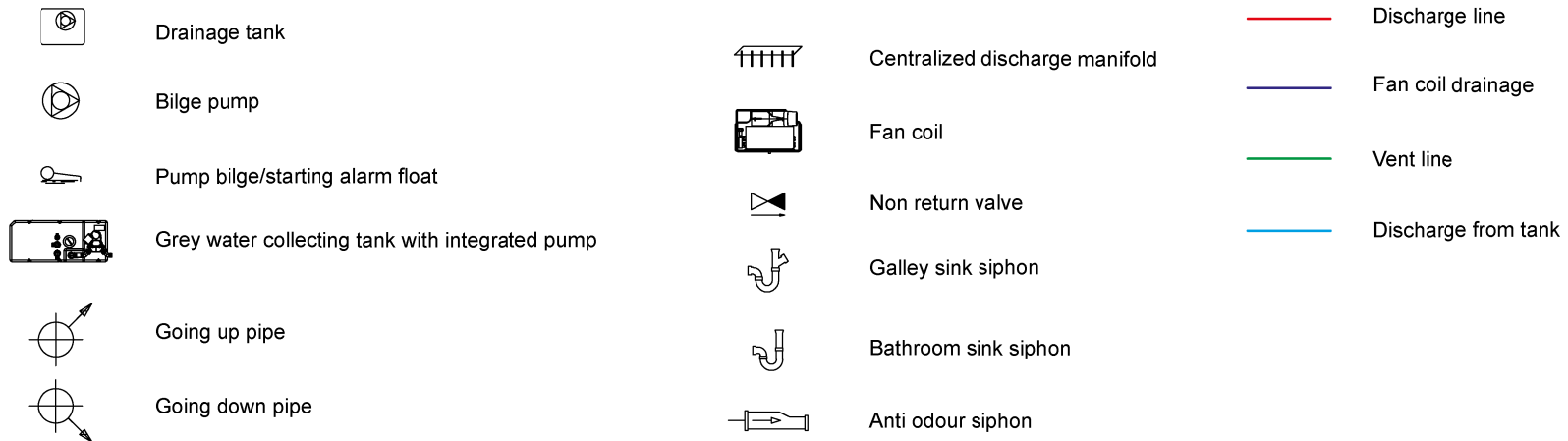
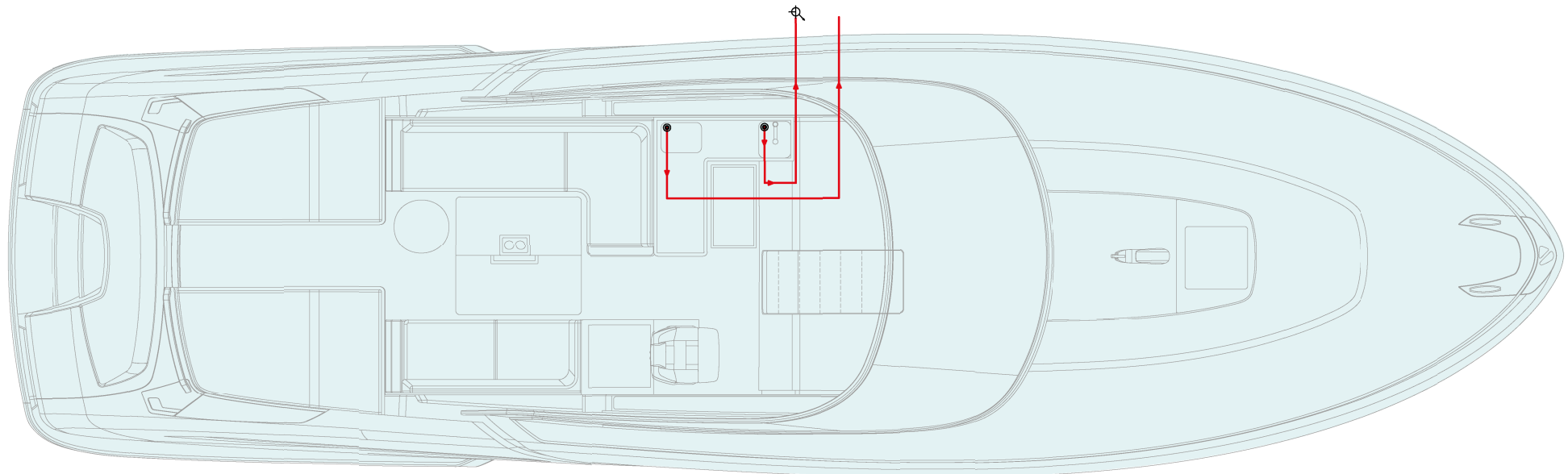

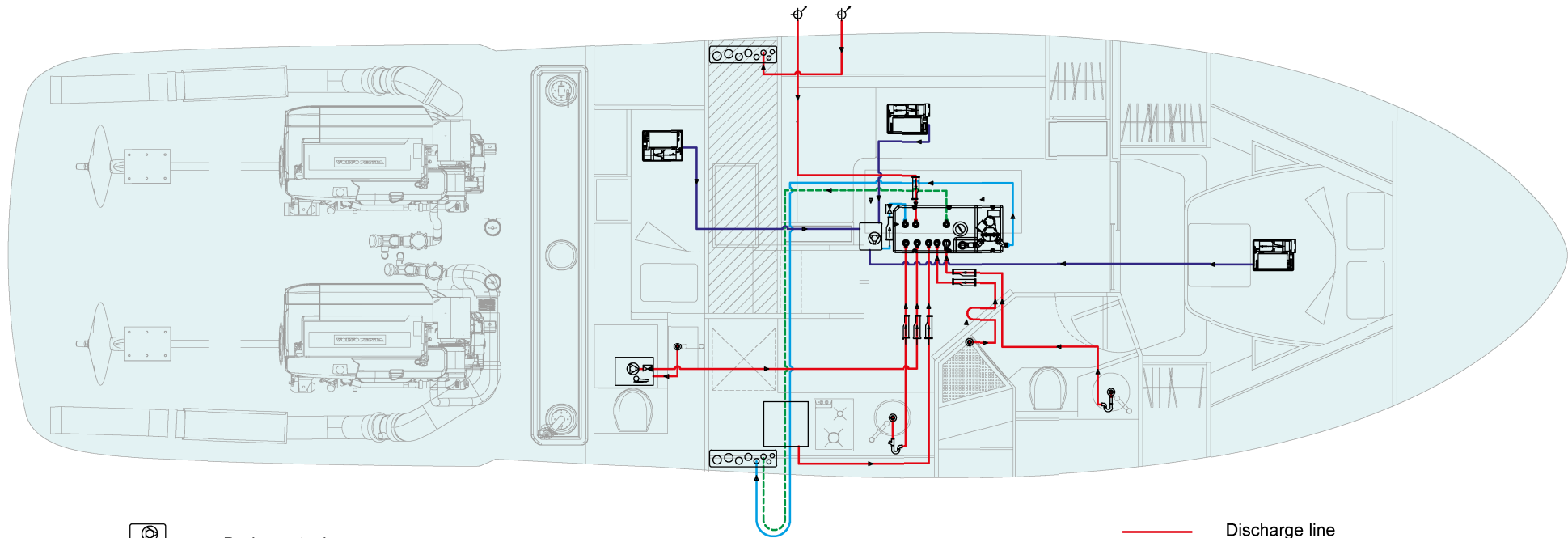







#### ENVIRONMENT

According to the regulation in force concerning cruising on Swiss lakes, grey water discharge shall only occur by means of shore suction, through the special discharge outlet, after having operated the three-way valve (4) located under the guests cabin, following the instructions shown on the special label.

## Grey water system diagram





- |   |   |  |                                |   |                     |
|---|---|--|--------------------------------|---|---------------------|
|    | Drainage tank                                   |    | Centralized discharge manifold |    | Discharge line      |
|   | Bilge pump                                      |  | Fan coil                       |   | Fan coil drainage   |
|  | Pump bilge/starting alarm float                 |  | Non return valve               |  | Vent line           |
|  | Grey water collecting tank with integrated pump |  | Galley sink siphon             |  | Discharge from tank |
|  | Going up pipe                                   |  | Bathroom sink siphon           |   |                     |
|  | Going down pipe                                 |  | Anti odour siphon              |   |                     |

**5.2.10 Grey water system maintenance**

Component	Operation	Notes and warnings
Grey water tank	Cleaning	<p>At least every month, drain the grey water tanks completely and rinse them a couple of times with clean fresh water.</p> <p>Periodically pour a specific disinfectant, in the quantity recommended by the Manufacturer, into the drains of sinks, bidets and showers, in order to prevent the formation of bacteria in the system, and the consequent release of bad smells.</p>
Grey water draining pump	Operation check	At least every month, check the status and the operation of the grey water pump, as well as its overboard drain.

### 5.2.11 Black water system

The blackwater system installed on board the yacht consists mainly of a black water tank (2) of 120 liters (32 gal) capacity, located in the middle of the yacht.

The system vent is situated inside the side starboard limber boards that can be inspected from the galley.

Before being discharged overboard, the vented air flows through a special active carbon filter which eliminates bad smells.

The tank is equipped with a level switch which starts the discharge pump when it detects a high black water level, and deactivates it once the level has decreased.

The system is equipped with a timer which delays useless pump start ups due to yacht's roll.

The level switch measures the water level inside the tank and sends alarm signals to the main electrical panel and to the WC control pushbutton panels.

The electric WC system is supplied and protected by the magneto-thermal switch (3) located on the main electrical panel, 24V section, locked with lead to inhibit it's operation.

Black water drain in automatic mode takes place only after the activation of the corresponding magneto-thermal switch on the main electrical panel; it is possible to drain black water manually or automatically, by pressing the selector switch on the main electrical panel. We recommend always checking the warning lights on the WC ceiling lights and on the main electrical panel, and anyway, draining the tank before entering the harbour, to prevent being forced to return to open sea again to carry out its draining.

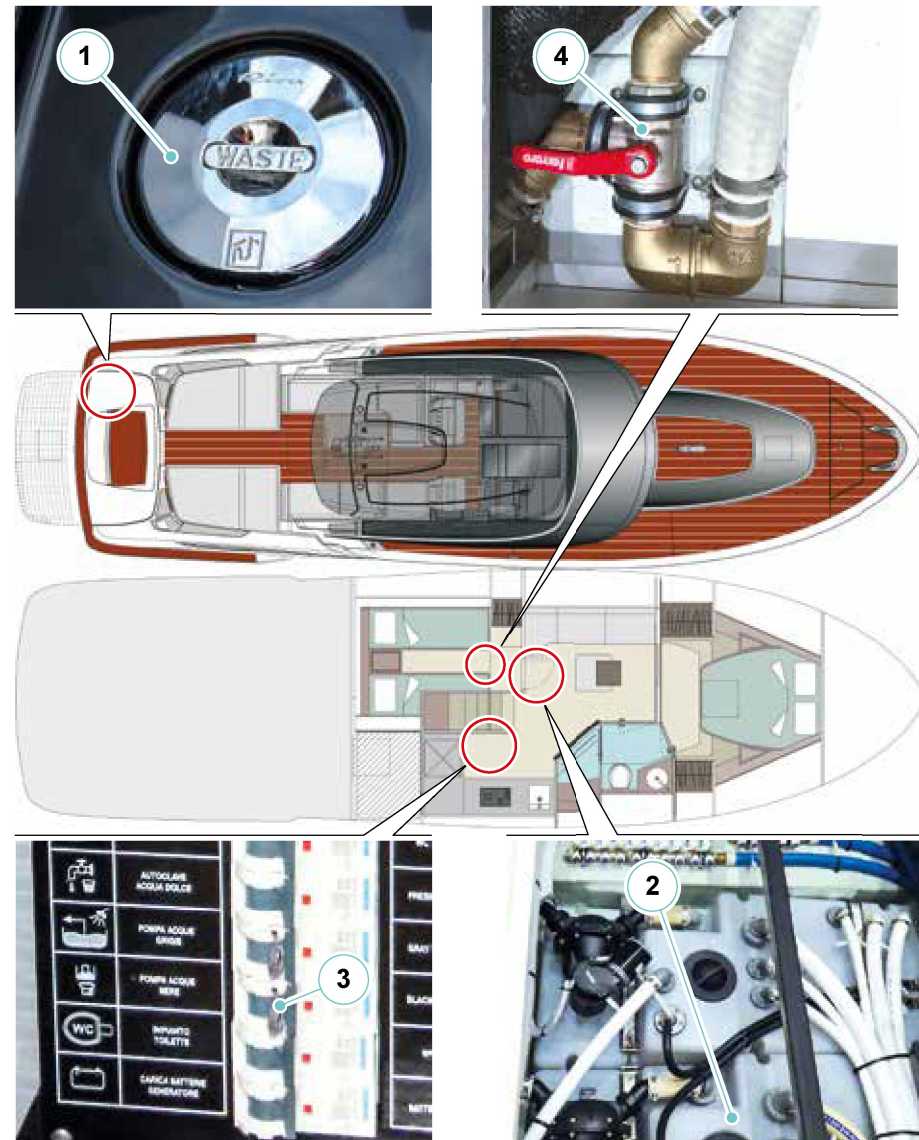

**CAUTION**

In case of yacht sinking risk, close the ball valve of the overboard drain.

**ENVIRONMENT**

For all pleasure yachts, drain at sea of on-board toilets is forbidden inside harbours, landings and moorings dedicated to yachts' anchor riding, and also within the limit of beaches visited by swimmers, as stated in the single decrees of the Port Authorities.

**ENVIRONMENT**

All pleasure yachts classified for a number of passengers exceeding the 15 units and equipped with toilets can drain the untreated sewage at sea according to MARPOL rules, only BEYOND the limit of 12 (twelve) miles from the coast, while navigating at fixed track and at the maximum speed allowed, anyway not lower than 4 knots.

**ENVIRONMENT**

According to the regulation in force concerning cruising on Swiss lakes, grey water discharge shall only occur by means of shore suction, through the special discharge outlet, after having operated the three-way valve (4) located under the guests cabin, following the instructions shown on the special label.

**ENVIRONMENT**

As it is possible to automatically empty the tank, we recommend that, according to the environmental rules in force, once entered in the harbour, you set the activation of the black water pump to manual mode only. The direct overboard drain of the WCs is regulated by the rules in force in the area where the yacht is navigating. When heading for the harbour, check the tank level and, if necessary, drain the tank at open sea before entering the harbour, always carefully taking into consideration the yacht's position. Except for organic waste, only very thin WC paper can be discharged into the sea toilets.

Suction takes place through the apposite intake situated on the outdrive that allows drainage of black water via suitable shore equipment.

Suction occurs through the special opening, located inside the aft peak allows discharging black waters (1) by means of the suitable equipment available in the harbour.

**CAUTION**

The intake situated on the outdrive has the indication "WASTE" to prevent the accidental introduction of liquids, as water or fuel.

## Black water system diagram

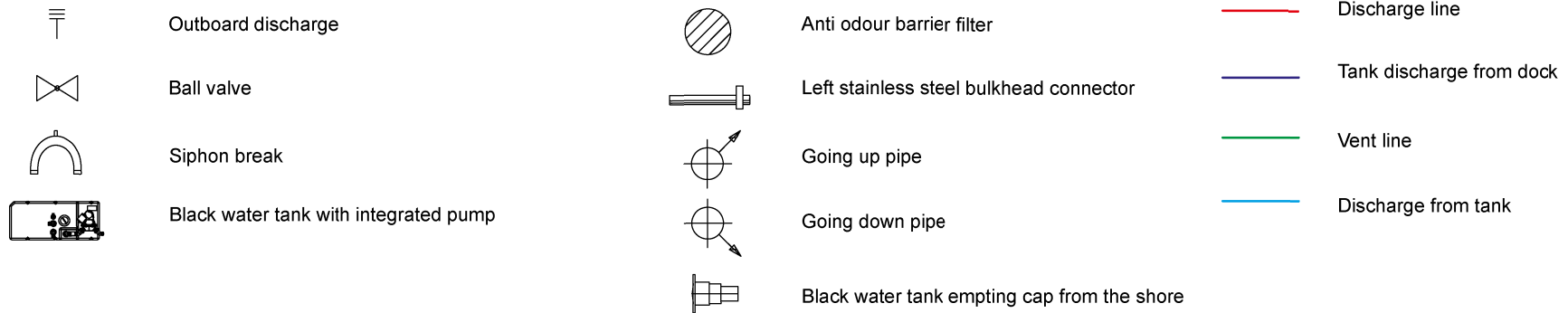
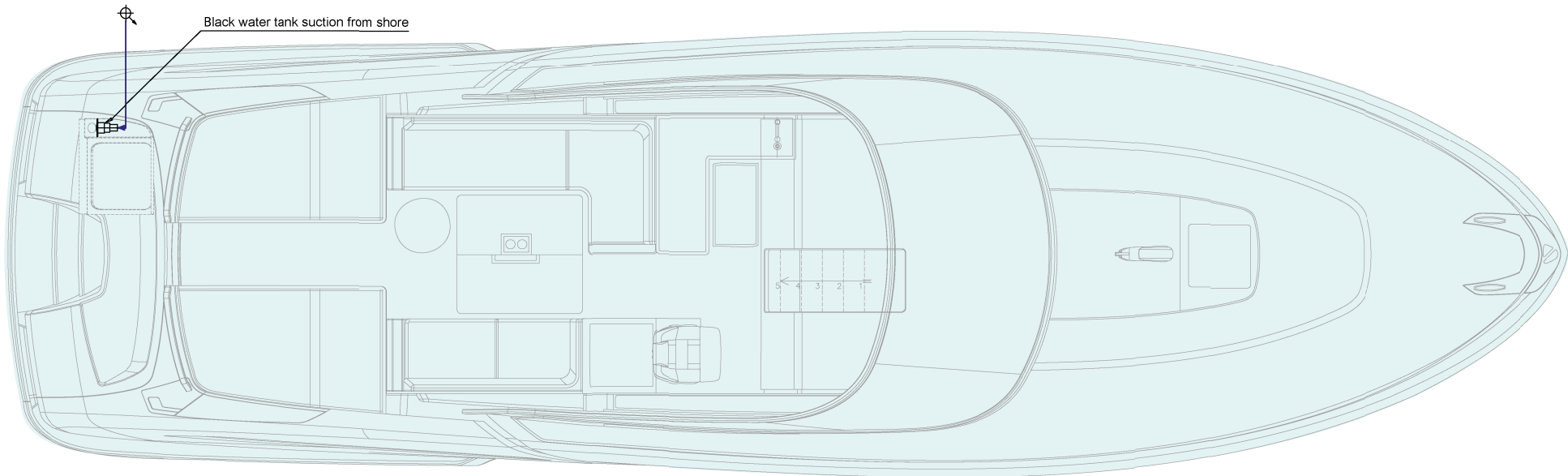

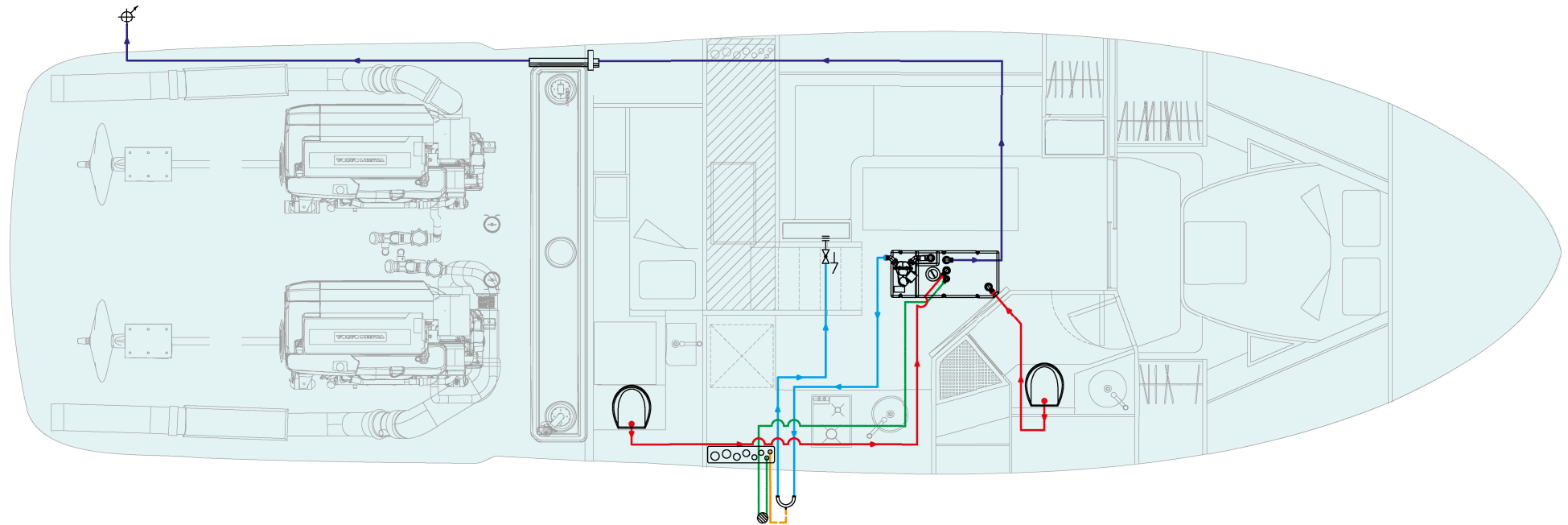

- |  |                                       |  |  |  |                          |
|--|---------------------------------------|--|--|--|--------------------------|
|  | Outboard discharge                    |  | Anti odour barrier filter                    |  | Discharge line           |
|  | Ball valve                            |  | Left stainless steel bulkhead connector      |  | Tank discharge from dock |
|  | Siphon break                          |  | Going up pipe                                |  | Vent line                |
|  | Black water tank with integrated pump |  | Going down pipe                              |  | Discharge from tank      |
|  |                                       |  | Black water tank emptying cap from the shore |  |                          |

## 5.3 WC TOUCH PANEL

### 5.3.1 Use

Moving your hand toward the wall switch, you will activate the usage indication: TOUCH will suggest you which button you should use blinking the relative icon.

This important innovative solution combine absolutely for the first time the advantage to have a two switches operating toilet and a very simple use for the guest, together with a very clean and elegant design.



### Cleaning mode (temporary lock-out)

In order to avoid the accidental activation of the toilet while cleaning the glass, it's possible to temporarily deactivate the TOUCH panel.

- Touch and keep one of the buttons for 5 sec.
- All the backlight will be turned OFF for 30 sec.

After 30 sec. TOUCH will turn ON the lights and will be operative.

### Night courtesy light

The TOUCH panel includes a night courtesy light.

Thanks to this feature, you can have a gentle blue illumination in the bathroom sufficient to avoid to turn ON the main light, that could be perceived as an interruption of the natural sleeping phase.

This function could be disabled, enabled permanently or in dynamic mode.

### 5.3.2 Setting of the courtesy light

#### Permanent activation of the night courtesy light

In addition to the icons, the border of the panel could be permanently illuminated as night courtesy light.

To turn the night light on or off, press and hold one of the buttons:

- After 5 sec. the panel is switched OFF. Keep touching.
- After additional 5 sec. the border backlight will flash and the new setting is recorded.

#### NOTE

If the Touch panel is not used for 10 hours, the border backlight will be turned OFF until next use (only if it has been set ON).

## Dynamic activation of the night courtesy light

The night light can be switched on temporarily, only when necessary. When this function is active, the border backlight will remain normally off. Moving your hand over the screen, the night courtesy light will be activated for 2 minutes.

To activate or deactivate this function, press and hold one of the buttons:

- After 5 sec. all the backlight will be turned OFF. Keep touching.
- After additional 5 sec. the border backlight will flash. Keep touching.
- After additional 20 sec. the border backlight will flash and the new setting is recorded.



### CAUTION

We recommend you do not use the residential function of the toilet, as the water inside the toilet, with the movement of the yacht, could escape and wet the floor.

### NOTE

Except for organic waste, only very thin toilet paper can be discharged into the sea toilets. Paper towels or napkins and sanitary towels can clog and damage the sanitary system.



### CAUTION

Make sure that toilets are electrically powered and that the black water system is operating before using them.

### NOTE

The full tank condition is indicated by the red icon light. Forcing the toilet discharge can cause the tank's overfilling.

### NOTE

The disabling of toilet protection on the drain can cause the tank to overfill.



### CAUTION

The toilet outboard discharge valve must be closed when the yacht is not in use for long periods of time.

**5.3.3 Black water system maintenance**

Component	Operation	Notes and warnings
Black water tank	Inspection and cleaning	At least every month, drain the black water tank completely and rinse it a couple of times with clean fresh water. Periodically pour a specific disinfectant, in the quantity recommended by the Manufacturer, into the tank, through the toilet drains, in order to prevent the formation of bacteria in the system, and the consequent release of bad smells.
Black water pump	Inspection and cleaning	For any operation on the black water draining pump, please address to the Manufacturer.
Solenoid valve for WC drain	Filter	Just before each solenoid valve there is an extractable filter, which retains impurities and must be cleaned at least once a month.

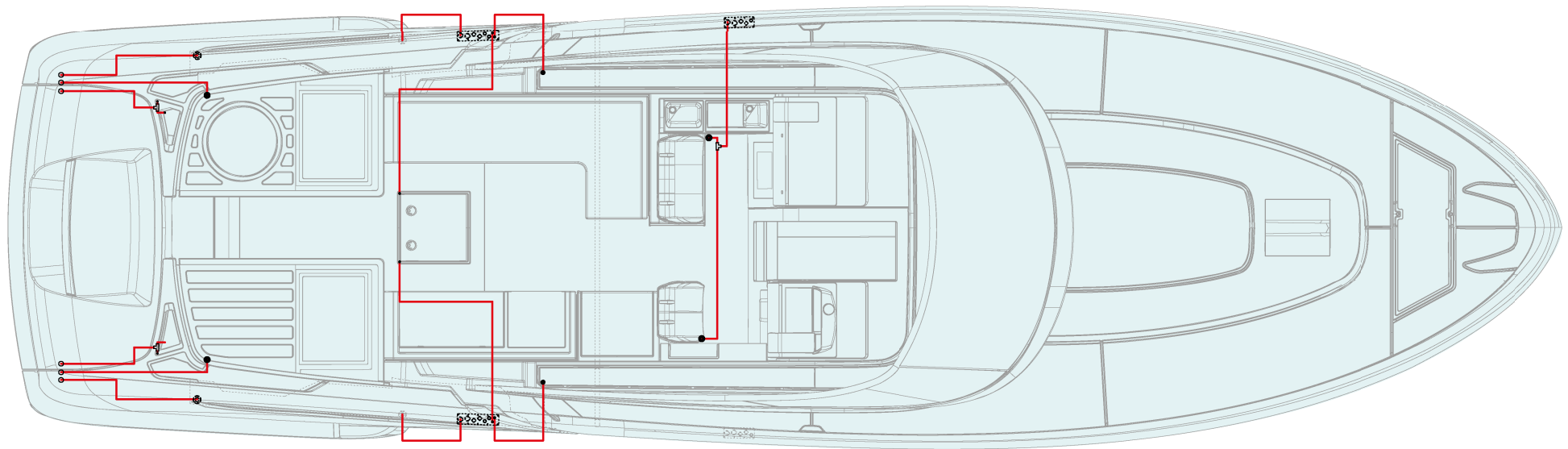

## 5.4 AIR CONDITIONING SYSTEM

Air conditioning includes cooling and dehumidifying in the summer (summer cycle), winter heating (winter cycle), air purification, circulation and ventilation in each season.

Air conditioning system (1) has been built on board.



### CAUTION

Ensure that the sealing valve is open before each start of the system and check the filter cleanliness.

By means of a monitoring system, if the two external fan coils (3) are switched ON, the fan coils in the guest cabin will automatically switch OFF, but the fan coils in the owner's cabin and in the galley are still working.

This automatism allows the external fan coils to operate at maximum efficiency.

If you prefer, you can manually operate the fan coils from their respective control switches and all the fan coils will be ON.

To inspect the fan coil (opt) remove the fan coil cover panel (2).

This optional can be only available if hydraulic bimini is not present.

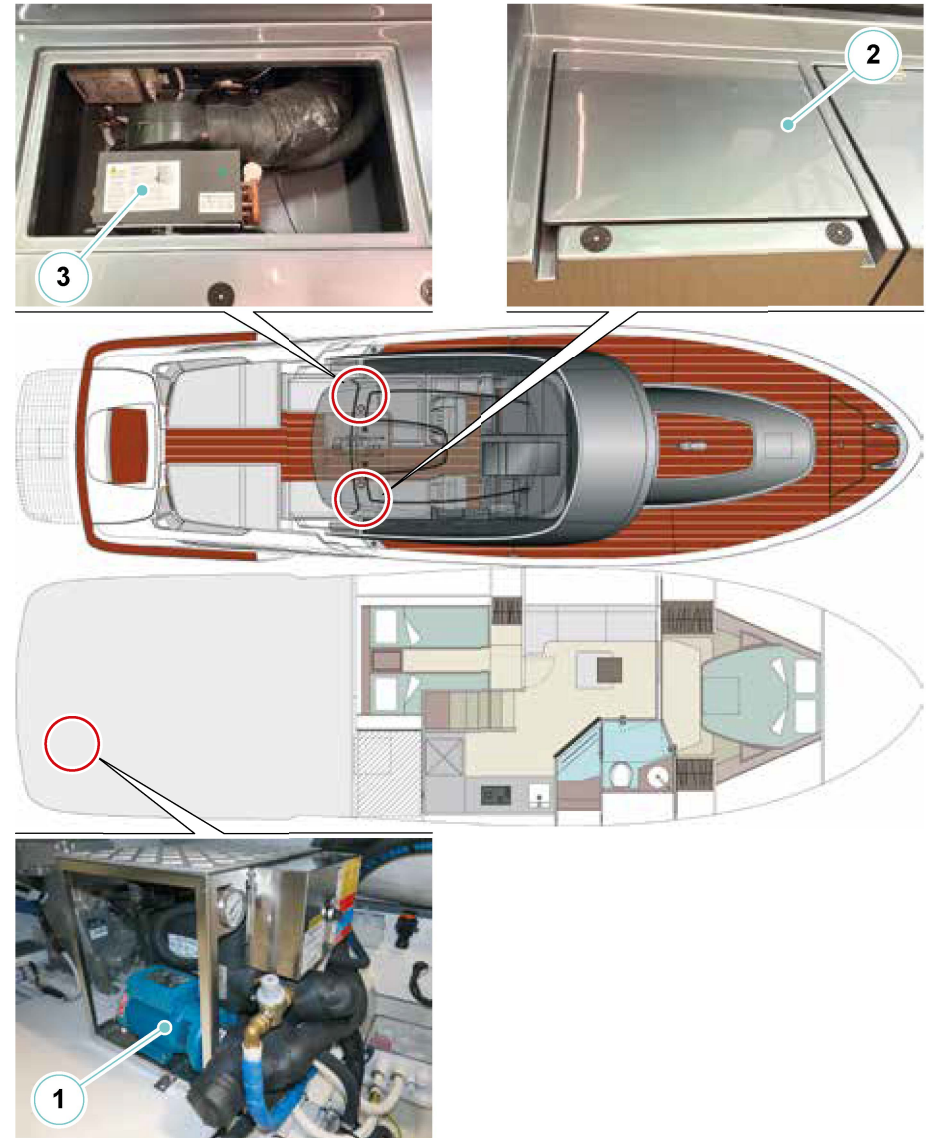

## Air conditioning system diagram

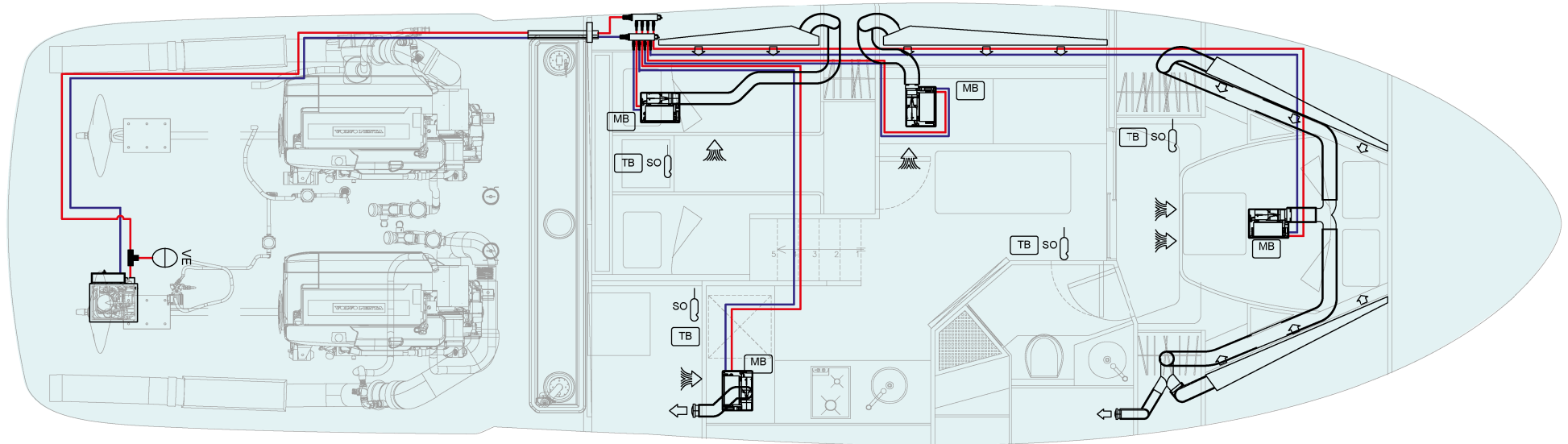

Temperature probe



Ambient setting panel



Motherboard



Fan coil mandate



Fan coil aspiration

5.4.1 Air conditioning system maintenance

Component	Operation	Notes and warnings
System circuit	Inspection and cleaning	Periodically check, where possible, that the condensate drains of the refrigerating unit are free to drain the condensate water.  Regularly check, where possible, that the insulation of the system circuit is intact and in good condition.
Fan-coils	Filter cleaning and replacement	At least 2 or 3 times a year, access the internal exchangers of each fan-coil and clean them carefully by vacuum cleaning, paying special attention not to damage the thin exchanger foils.  Replace the suction filter when necessary.
Sea cock	Filter cleaning and inspection  Sea cock cleaning	Cleaning the sea cock strainer is to be carried out according to how often the system is used and to the pollution conditions of the intake waters (seaweed, mucilage, etc.); in any case, at least once a month.  Before cleaning the strainer, remember to close the sea cock cut-OFF valve and then proceed with cleaning. Once this operation is finished, remember to re-open the valve.  Slowly open the filter cover, to make sure the sea water intake valve is properly closed.  This operation has to be carried out from the outside, therefore the yacht must be in a dry shore or you can ask the intervention of a diver.  If the yacht is in the water, before working on the sea cocks, disable the start up of the engines, the generators and the sea water pumps.



**CAUTION**

The clarity of the operating principle is crucial for the correct operation and maintenance of the system, for detecting anomalies and for maintaining the system in full efficiency.

Please read the manufacturer's manual carefully.

**NOTE**

For commissioning, operation, and system operation, consult the manufacturer's manual beforehand or contact RIVA After Sales & Service Department in case of any uncertainty.

### 5.4.2 Inspection and cleaning of the sea water intake strainer

The following operations must be carried out for sea water intake strainer (1) inspection and cleaning.

- Tightly close the intake valve to the sea and then slowly open the strainer cover.
- Once removed the cover, remove the filter element; clean it with a brush and rinse with water.
- Clean the strainer housing.
- Fill the strainer with water to prevent the vacuum pumps turn damaging the system.
- Check and, if necessary, replace the strainer cover seal.
- Replace the strainer inside the container; close the strainer cover.
- Re-open the intake valve and check that there are no leaks from the strainer cover.



**CAUTION**

Before restarting the air conditioning system, make sure that the intake valve is completely open.  
Before servicing the sea water line, disable the operation of the connected utility.

## 5.5 INTERCEPTORS SYSTEM

To improve the yacht's performance during navigation, it is advisable to correct or seek out the best longitudinal trim at various speeds.

For this purpose they have been installed on the transom two electrical interceptor (1), one on the starboard and one on the port side, which allow the variation both longitudinal and transverse alignment.

The interceptors are controlled automatically by the ATCS (Automatic Trim Control System).

The system control unit is situated in the engine room.

In principle, lowering and raising the interceptors is obtained, respectively a lowering and a raising of the yacht's bow.

Correct positioning of the interceptors results in a stable and ideal set-up that can increase speed while reducing fuel consumption.

In particular navigation conditions, when the effect of lateral forces of the sea, sea currents and wind, the yacht assumes a tilted position, to restore the normal conditions keeping the route, it is necessary to act on the steering wheel or with the use staggered the interceptors.

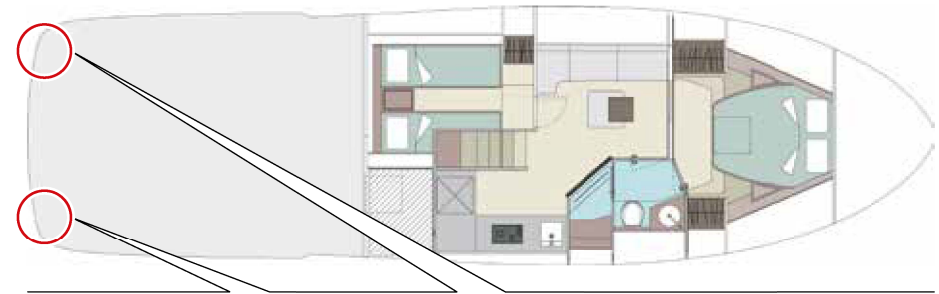

### CAUTION

Interceptors are normally used during cruising, both to make it more comfortable and to achieve better performance of the yacht, according to the sea and navigation condition, and the yacht loading.



### CAUTION

When using reverse gear, set the interceptors fully up, otherwise they may be damaged.

### 5.5.1 Advice on interceptors operation

Some advice will prove useful to familiarize with the interceptors.

- After the hull is brought in gliding way position, adjust interceptors position to find the most favourable angle for navigation.
- At high speed it is advisable not to operate the interceptors at the same time, one up and one down, but carry out these operations separately to avoid sudden lurching; it is nevertheless possible to operate them together in the same direction.
- With calm sea, the best interceptors position is the one allowing maximum speed with minimum yacht resistance.
- With rough sea “at bow”, lowered interceptors will allow the yacht to bump less and to navigate more comfortably even if speed will be decreased.
- With rough sea “at stern”, lifted interceptors will raise the bow thus avoiding unpleasant listing.
- With side wave motion or asymmetrical side load, the best stability is obtained with staggered interceptors.
- In case the yacht is not underway, raise the interceptors completely.



#### CAUTION

The Interceptors, as well as transmission systems, can suddenly change the yacht direction if operated too rapidly or with high angles of incidence, especially with increasing yacht speed and during manoeuvres (as they are usually sized and optimized for intermediate speed). It is therefore necessary to get well familiar with their use and related devices reactions in any condition and especially at high speeds.



#### CAUTION

The manual use of interceptor (“trim assist” function disabled or override), running at high speed, requires special attention and it is normally not recommended.



#### DANGER

Always make sure that passengers are seated before undertaking adjusting manoeuvres on the interceptors, especially if navigating at high speed.



#### WARNING

The yacht is equipped with a trim correction system with interceptor equipped with an “autotrim” function which is always recommended for use (“AUTO” condition) to benefit from optimal set-up conditions. The use of interceptor functionality in manual mode, particularly at high speeds, requires appropriate attention.

5.5.2 Interceptors system maintenance

Component	Operation	Notes and warnings
Interceptors system	Check and replacement	To check and replace the interceptors, refer to the Manufacturer's installation manual.



**CAUTION**

Periodically clean interceptor to remove any corrosion that may affect their efficiency.

## 5.6 THRUSTERS

Your yacht is equipped with one or two thruster(s):

1. Bow (standard);
2. Stern (optional).

Manoeuvring thrusters are simple and robust accessories, but require some special attention:

- The thruster must be used at a very low speed, or without fresh way; at higher speed, more correct reactions can be obtained with the offset use of the gear boxes;
- The Manufacturer, considering the excessive overheating, has foreseen a continuous run of max. 3 minutes. The electric engine **(3)** is equipped with a built-in protection magneto-thermal, which stops the engine, in case it overheats and starts it again once it has cooled down. You should consider this when planning the manoeuvres to carry out;
- Each time the yacht is lifted, check the condition of the thruster, of the protection anode and of the fastening system.

### NOTE

For further information on use and maintenance, please refer to the manufacturer's manual.

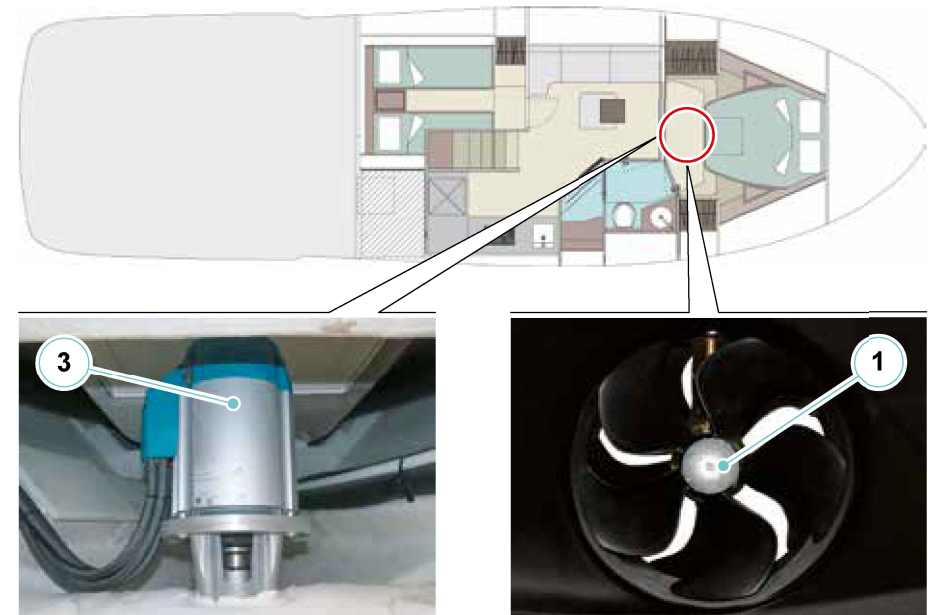

**5.6.1 Use of the thrusters**

Before using the thrusters, activate the magneto-thermal switch (2) on the electrical panel (auxiliary services 24V section), situated at the bottom of the galley area, and the relevant helm position switch. After having activated power supply, press the "ON" button on the helm position joystick.

The warning light indicates that the device is ready for use.

The electric engine of the thruster is controlled by a joystick (1).

When the thruster is no longer in use, press button OFF.

Before getting on shore, disconnect the switch and the battery breaker.



**DANGER**

During stern thruster operation, pay attention to possible swimmers or small yachts which may be close to the thruster openings. Do not test the thruster when the yacht is outside water, unless you are sure the workers are at safety distance from the thruster tunnel.



**CAUTION**

When the stern thruster is not used, always disconnect the control unit.



**CAUTION**

Remember to disconnect the power supply of the system when manoeuvres are ended or during normal navigation.

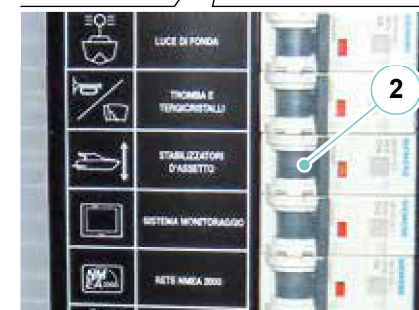
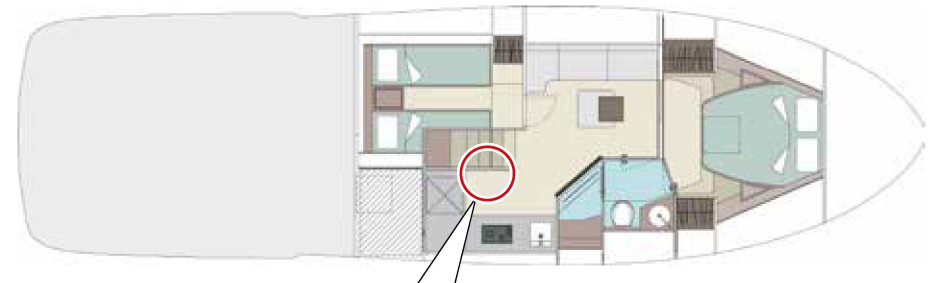
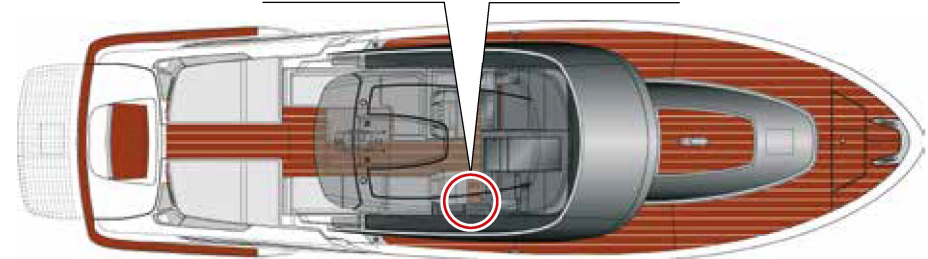

**CAUTION**

When the thruster stops supplying the thrust while the electric engine turns, there might probably be a fault in the transmission system. In this case, immediately disconnect the bow thruster.

**CAUTION**

Never activate the thruster longer than one second when the yacht is at dry shore, because this can damage the electric engine seriously.

**CAUTION**

When you leave the yacht, or during maintenance work on the thruster, you must turn all the battery breakers on board to the manual OFF position.

**CAUTION**

In case it is necessary to replace a fuse on the system thruster, to involve a technical competent naval electrician.

**NOTE**

For further information on use and maintenance, please refer to the manufacturer's manual.

**5.6.2 Thruster battery breakers**

The battery breaker ensures that the thruster is completely disconnected from the electronic circuit and therefore out of use.

To get to the battery breaker is necessary:

- Press OFF on the thruster control panel on the helm position.
- Disconnect the magneto-thermal switch of the thruster on the 24V electrical panel.
- Press the button on the battery breaker in the engine room.

**WARNING**

This is necessary to prevent the thruster from being actuated by unqualified personnel or when maintenance is required.

## 5.7 GYROSCOPIC STABILIZER (OPTIONAL)

The gyroscopic stabilizer (2) is located aft of the engine room.

This system allows to soften the roll of the yacht when navigating in rough seas.

The gyroscopic stabilizer can be controlled by means of the control panel (1) on the helm position.

### NOTE

For further information on use and maintenance, please refer to the manufacturer's manual.

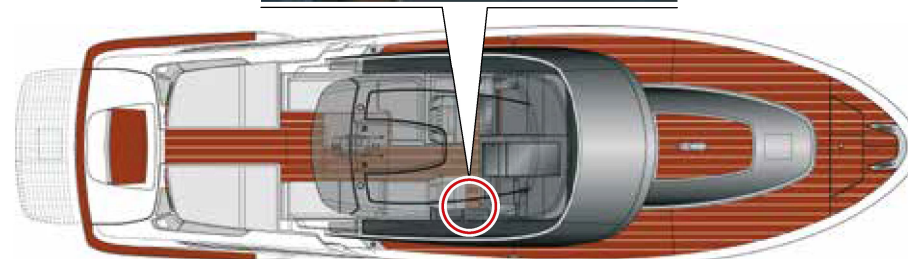

## 5.8 SWIM LADDER

The swim ladder is positioned inside the stern starboard hatch. The position of the swim ladder is shown on the helm position in the monitoring system. If the swim ladder is not stored and the engine keys are activated, an alarm appears on the navigation display.



**DANGER**

NEVER start navigation when the swim ladder are not correctly retracted.



**DANGER**

When getting on and off the yacht, it should only be used by one person at a time, always making sure that the maximum load capacity defined by the manufacturer is not exceeded.



**DANGER**

In no way use the swim ladder when the engines are running. Pay utmost attention to not approach to the zone of the interceptors and propellers, because they could be accidentally activated.

For the swim ladder extraction proceed as follows:

1. Open the stern hatch.
2. Turn the retaining pin (1) and retain the swim ladder.



3. Pull out the swim ladder completely.

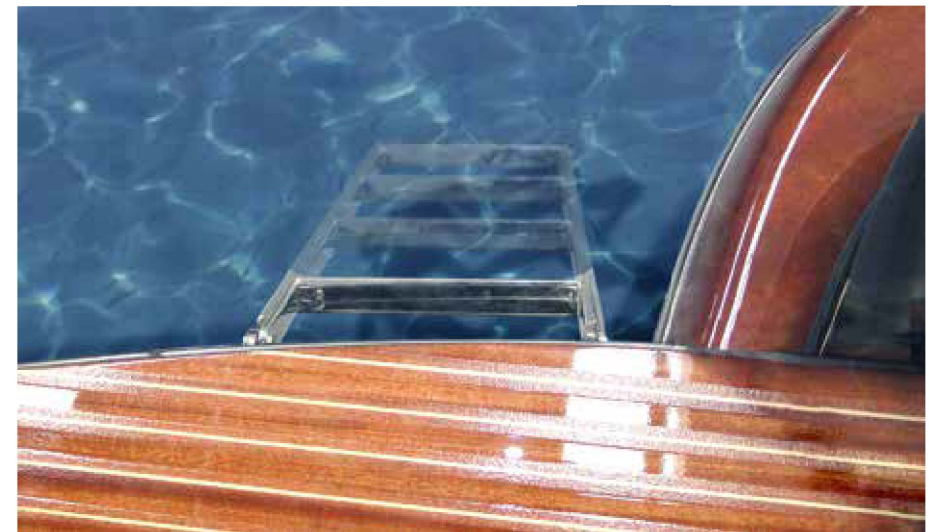



**CAUTION**

Make sure that the swim ladder is correctly extracted and positioned before going down to water.



**CAUTION**

Pay attention because the ladder can be slippery. Secure the grip before starting the return on board.



**WARNING**

For a safe use of the yacht, when you are stopped at open sea and you are alone on board, always keep the swim ladder open.



**DANGER**

Risk of electric shock from leakage currents. Never swim in waters near harbours or marinas.



**CAUTION**

Do not use the swim ladder as a springboard.



**DANGER**

Pay attention to moving parts and to your hands.

**MAINTENANCE**

At least once a week carry out an accurate washing.

At least once a month:

- Check for corrosion signs;
- Grease the pulley gliding races of the steel cable;
- Tighten the fixing bolts.

At least once every three months, grease the swivel pins and the sliding sleeves.

5.8.1 Swim ladder maintenance

Component	Maintenance	Notes and precautions
Swim ladder	Cleaning	The swim ladder are located in a particular position compared to all other on-board equipment, because they are continuously in contact with water, salt and exhaust gas, they require therefore a more accurate cleaning.



**DANGER**

During cleaning or maintenance operations, make sure that nobody can activate the gangway, the swim ladder and the stern hatch, because they could cause serious injury to people; it is recommended to disconnect the power supply.

## 5.9 GANGWAY

Your yacht is equipped with a multifunctional hydraulic unit (2), which controls the gangway (1) and is situated starboard the engine room.

The movement of the gangway is controlled by the dedicated panel (3) installed astern the cockpit.

The position of the gangway is shown on the helm position in the monitoring system. If the gangway is not closed and the engine keys are activated, an alarm appears on the navigation display.

### NOTE

In case of pump fault, or power supply failure, it is possible to operate the hydraulic control unit by means of the manual emergency pump, by operating the relevant lever provided by the Manufacturer.

For the correct operations to be carried out, please refer to the Manual supplied by the Manufacturer.



### CAUTION

The hydraulic equipment, although being easy to handle, may cause damage to property and harm to people. Its use is recommended only to well experienced people.



### CAUTION

Do not use as a trampoline the gangway.

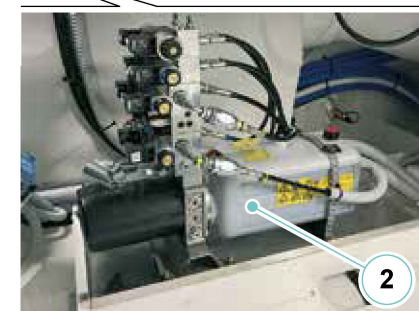
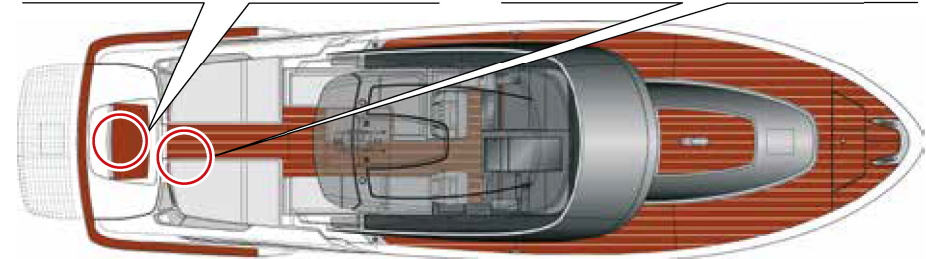
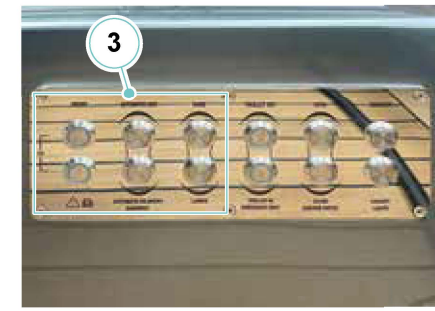

**DANGER**

The gangway, for boarding and leaving the yacht, shall be used only by one person at a time; make sure never to exceed the maximum capacity stated by the manufacturer.

Never operate the gangway when someone is passing on it; before activating it and during operation, make sure that no one is within its moving range.

When walking on the gangway, be cautious and keep hold to the handrail; as it is made of rope, it cannot be considered a rigid and safe support, but simply a help to keep balance.

**DANGER**

Do not navigate with the gangway incorrectly restored.

Make sure that the gangway is properly closed before starting navigation.

**CAUTION**

In order not to compromise the gaskets of the gangway, wash it avoiding that pressurized water enters the box.

**DANGER**

Pay attention to moving parts and hands.

**MAINTENANCE**

At least once a week, wash with fresh water and thorough cleaning.

At least once a month:

- Check the oil level of the control unit when necessary to refill;
- Check leakage of oil;
- Check the operation of the emergency pump;
- Check for corrosion;
- Lubricate the grooves of the steel cable sliding pulleys.

At least once every 6 months;

- Lubricate the pins of joints and sliding sleeves;
- Tighten anchor bolts.

**CAUTION**

Always check the correct positioning of the gangway from the shore.  
Never jump on the gangway.

**CAUTION**

Place the gangway so that it does not touch the shore even following normal yacht swings or as a result of tides.

If the gangway is to be forced against the shore, it may be seriously damaged.

**NOTE**

For further information on use and maintenance, please refer to the manufacturer's manual.

**5.9.1 Gangway system maintenance**

Component	Maintenance	Notes and precautions
Hydraulic control unit	Oil top up	Check the oil level inside the tank every month and anyway before each navigation. Top up keeping the oil level at about three-quarters of the tank's capacity, and using the type of oil recommended by the Manufacturer.
Gangway	Cleaning	As this device is located in a very critical position compared to all other on-board equipment, being continuously in contact with water, salt and exhaust gas, they require a more accurate cleaning.



**DANGER**

During cleaning or maintenance operations, make sure that nobody can activate the gangway, they causing serious injury to persons, by cutting OFF power supply.

**NOTE**

Improper use of the hydraulic systems, altering of the flow calibration, disrespect of manoeuvring procedures described in this manual relieves RIVA of all liability.



**ENVIRONMENT**

Do not discharge hydraulic oil in the sea, but in the special areas for toxic waste disposal.

### 5.10 STERN HATCH

The yacht is equipped with a stern hatch (1) which when fully open acts as a swimming platform function.

For handling the hatch, use the buttons on the dedicated panel (3) installed astern the cockpit.

The position of the hatch is shown on the helm position in the monitoring system. If the hatch is not closed and the engine keys are activated, an alarm appears on the navigation display.

When the engine is switched OFF, the pushbutton lights up and remains illuminated while moving and until the hatch is closed.

When the engine is switched ON, pressing the stern hatch open command will illuminate and a beeper will alert you that the hatch is open.

Handling is carried out via a multifunctional hydraulic unit (2) situated starboard the engine room.

With the stern hatch is open you can access the 2 compartments (4) at the starboard side and port side of the yacht.

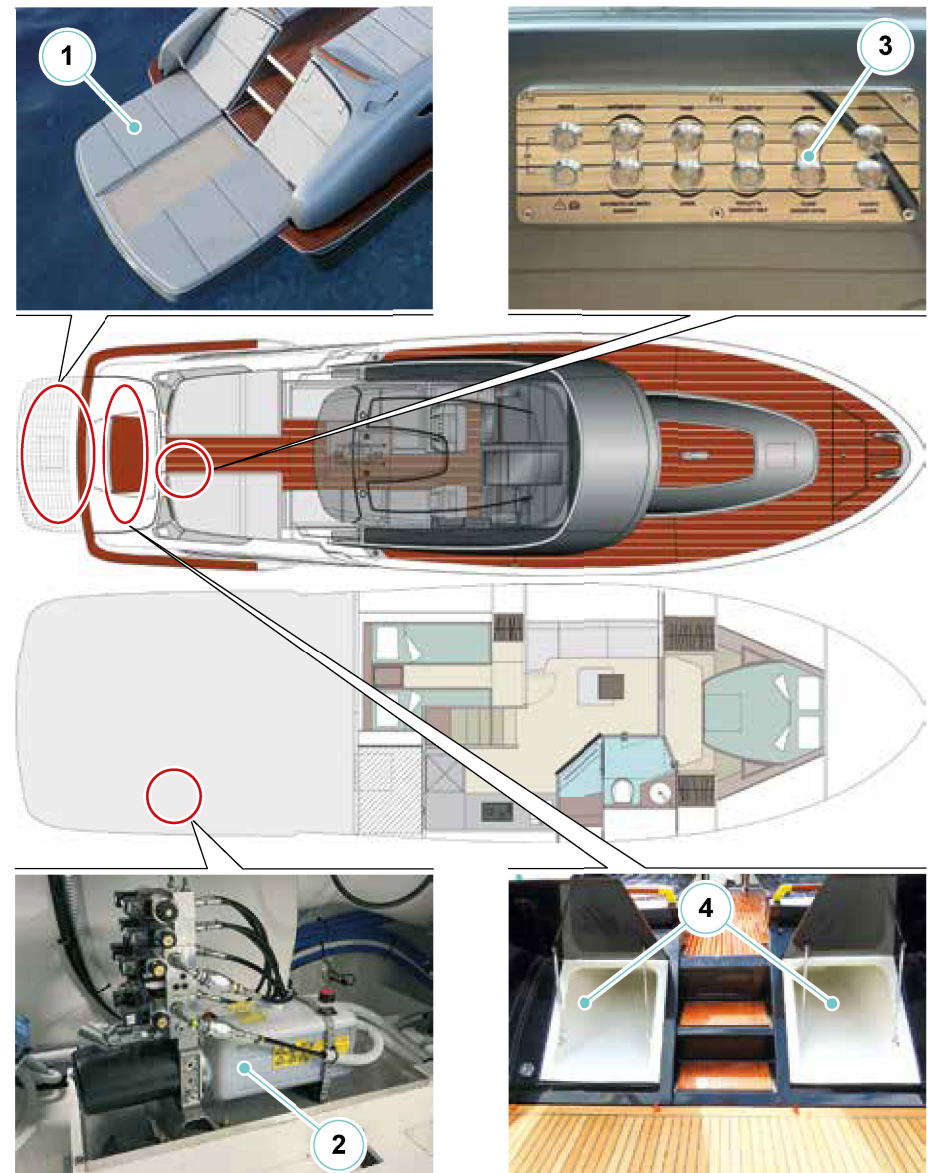

## 5.11 PROPULSION SYSTEM

### 5.11.1 Propulsion engines

The diesel engines are designed and produced with cutting-edge technology. The propulsion engines installed on board of your yacht, after accurate designing studies by RIVA, are perfectly suitable for this kind of yacht, also thanks to the high performances they are capable of providing. You will thus be able to enjoy high performance along with full reliability, to the advantage of your navigations and your and your guests' fun. The propulsion engines are provided with advanced electronics, in order to enhance the yacht's performance and reducing fuel consumption and exhaust emissions. Remember, however, that operation without problems and the expected high power may be attained only if the prescribed maintenance schedule is complied with and if recommended fuel and lubricants are used.

Each engine **(1)** is directly flanged to its gear box and is installed on suitable elastic supports **(2)** which absorb vibrations and allow minimum movement of the engine; in this way, the structures and the devices connected with them are not damaged.

In addition, the elastic supports allow easy adjustment of the position of the engines, either during new installation or after the expected settlement. The engines are equipped with diagnostic and monitoring electronic systems, whose aim is to check the important operating parameters of the engines and to alert the Captain in case they exceed the admitted tolerance.

#### NOTE

The documents provided by the Manufacturer are very important in case of repairs carried out on the engines and, therefore, they must be preserved with care.

We suggest reading carefully and in detail the user Manual provided by constructor.

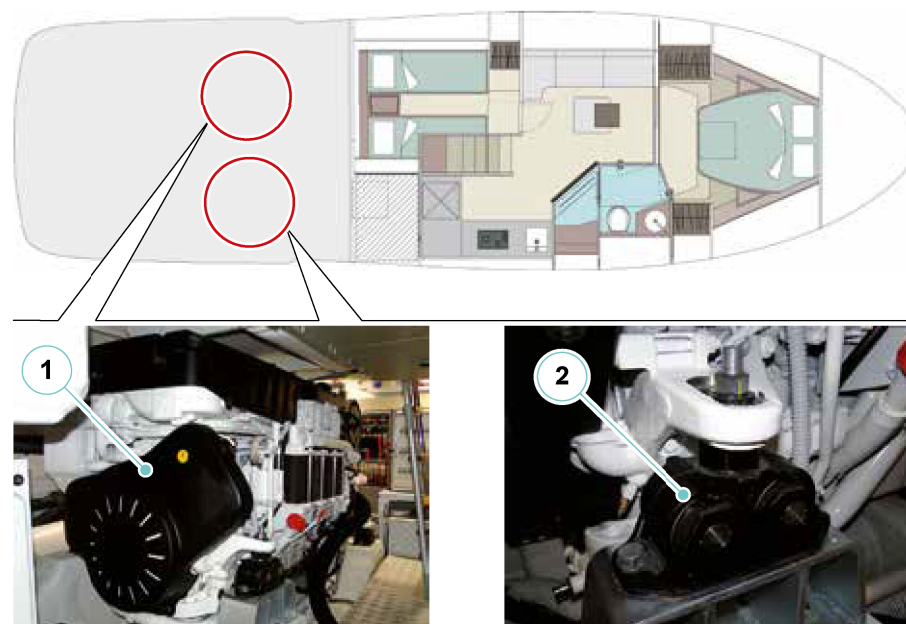

**NOTE**

The engines are equipped with an emergency stop in case of a malfunction. Please refer to section “Engine emergency stop” in this Manual.

**NOTE**

We recommend that ordinary and extraordinary maintenance operations be carried out by specialised and authorised personnel or contact the RIVA After Sales & Service Department.

**5.11.2 Engine Specifications**

Displacement	12.78 l (779.7 in <sup>3</sup> )
No. of cylinders	6 In-line
Compression ratio	17.1:1
Description	4-stroke, direct injection, turbocharged, and post-refrigerated
Crank shaft power @ 2300 rpm	735 kW (1000 Hp)
Maximum torque	3527 Nm (1800 rpm)
Weight (in dry conditions)	1635 kg (3.604,5 lb)

**NOTE**

For further information on use and maintenance, please refer to the manufacturer’s manual.

Propulsion engines diagram

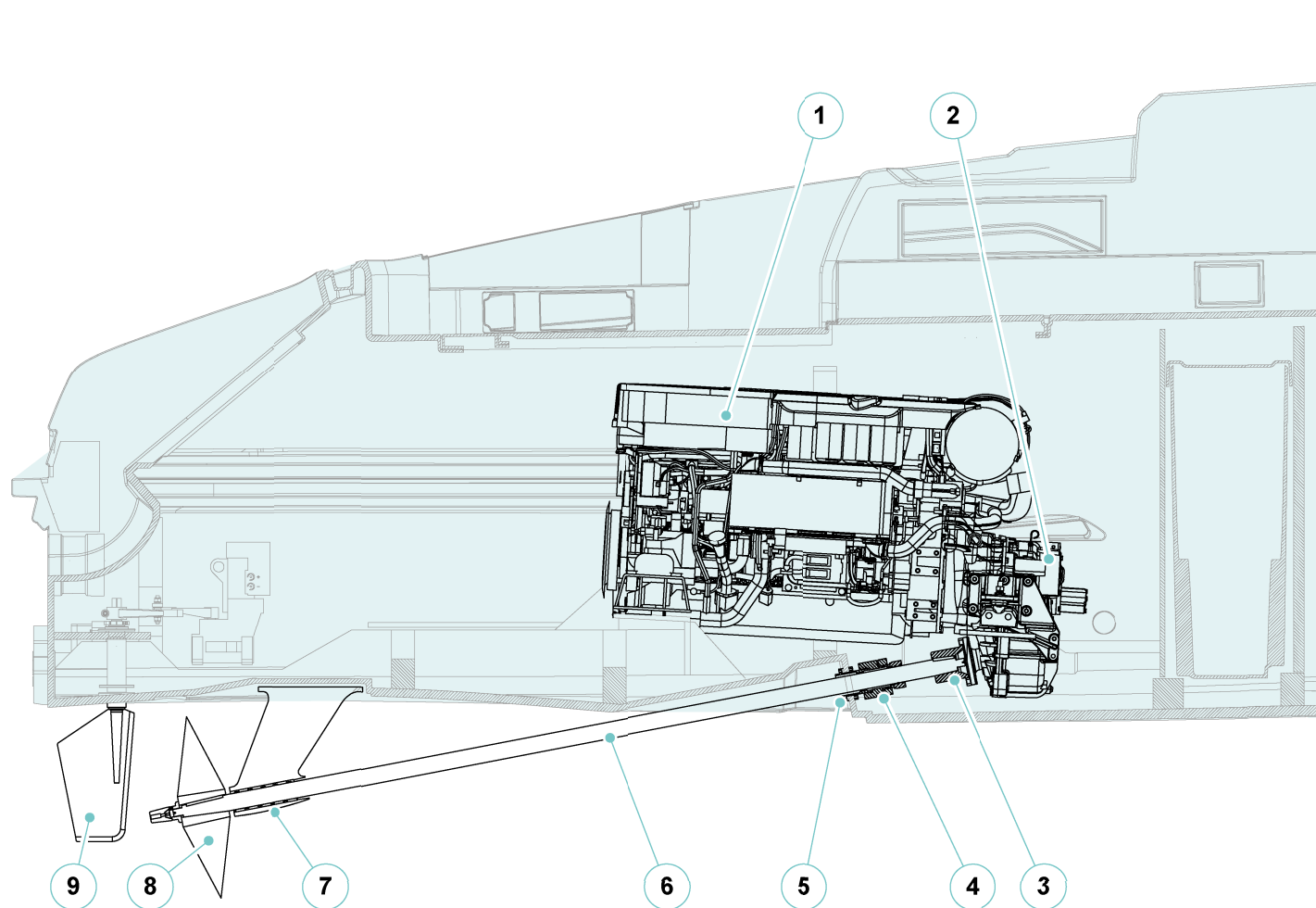

- 1. Engine model Volvo Penta D13-1000 - 1000Hp
- 2. Inverter ZF 500-1 IV (r.r 1,964:1)
- 3. Shaft flange

- 4. Microtem seal
- 5. Through-hull for Microtem seal
- 6. Propeller shaft

- 7. Propeller shaft support
- 8. Propeller
- 9. Rudder

### 5.11.3 Propulsion engine maintenance



#### DANGER

Any maintenance intervention on the engines is to be carried out with the engines shut OFF, after they have sufficiently cooled down.



#### DANGER

Do not approach the V-belts or the engines pulleys with he hands, when the engine is running.



#### DANGER

Because of the high temperature in the engine room, oil or fuel leaks can evaporate and create a serious risk of fire. Regularly check the integrity of the system.

#### NOTE

Only use the approved fluids indicated by manufacturer, otherwise the warranty given by the Manufacturer is voided.



#### DANGER

A wrong use, a wrong maintenance, tampering and replacement of pieces, can cause serious damages or mortal events, beyond damaging the equipment.

The interventions on the electrical and mechanical equipment must be carried out by qualified staff after having examined the manual delivered by the Manufacturer.



#### CAUTION

It is absolutely necessary to view together with RIVA the documentation for the different components provided by the manufacturer; for any problem relevant to use or maintenance, please contact the Service Centres listed in the documents provided by the manufacturer.

Anyway, in case of need, some little interventions can be carried out by the staff on board, after consulting the operation manual.



#### CAUTION

During navigation, regularly check the cleanliness of the sea water strainer baskets.

If the yacht is navigating in a dirty sea area, check the condition of the strainers and clean them.

Caution is very important to prevent damaging mechanical parts (engines, generators, etc..), draining systems and to prevent jeopardizing the safety of the yacht.



**CAUTION**

Do not tamper or try to repair the injection pump or its power unit on a diesel engine. In case the lead seal is damaged, this will void the engine warranty.  
Have the injection pumps or the injectors repaired only at an authorised Service Centre.



**ENVIRONMENT**

Dispose of waste materials (engine oil, fuel, filters, etc..) with respect for the environment and according to the rules in force.  
Use only authorized disposal procedures and, in case of doubts, contact the Port Authority.

Component	Maintenance	Notes and precautions
Lubrication system	Oil level check	<p>Check the oil level by means of the special dipstick; make sure the level is included in the allowable range (MIN - MAX). Do not start the engines if the oil level is not included between the two reference marks, as indicated in the Manufacturer's Manual.</p> 
	Oil and oil filter replacement	Replace engine oil according to time intervals and oil type suggested by the Manufacturer.



Component	Maintenance	Notes and precautions
Cooling system	Drain the cooling system	<p>Drain the coolant only when the engine is stopped; follow the procedure indicated by the Manufacturer.</p> 
V-belts	<p>Filling and draining</p> <p>Check the belts condition</p> <p>Check the tension</p> <p>Replacement of v-belts</p>	<p>Refill with a mixture of drink water and antifreeze on ethylene glycol basis or anticorrosion agent.</p> <p>Make sure that there are no cracks, no traces of oil, no signs of overheating and no signs of wear; if so, replace them.</p> <p>Use the proper gauge supplied by the Manufacturer to measure the belt tension.</p> <p>Replace the v-belts at the intervals recommended by the Manufacturer.</p>

## 5.12 GEARBOX

The yacht is equipped with 2 marine gearboxes performing the following main tasks:

- A coupling the propulsion engine with the sterndrive and reducing the number of propeller revolutions;
- Reversing the motion direction;
- Stopping the propeller shaft motion (idle).

The gearboxes are directly flanged on each engine by means of cardan shafts. Torque transmission occurs by means of oil-lubricated gears; oil is cooled, by means of a heat exchanger, by the sea water contained in the cooling circuit coming from the engine.

With the use of the gearbox controls, 3 operating modes are available:

- Idle: the output shaft connected to the propeller shaft, does not transmit any rotation of the stern drive.
- Forward run: the output shaft connected to the propeller shaft, has the same rotation direction of the input shaft.
- Reverse run: the output shaft connected to the propeller shaft has the opposite rotation direction of the input shaft.

A valve/distributor, controlled by the throttles on the helm position, controls the engagement of backward and forward gear.

The gearboxes are equipped with an incremental control system of pressure which allows clutch engagement at a low pressure, to progressively increase pressure until the clutch is completely engaged.

This system enables a soft engagement of gears and minimizes pulses upon engagement.

Each gearbox is provided with a suction filter along the lubrication circuit, upstreams of the pump, with the purpose of preventing the introduction of particles and residues with the pump's suction. This filter must be cleaned according to the schedule indicated by the Manufacturer.

Furthermore, each gearbox is provided with a second filter of "cartridge" type, connected between the pump's outlet (delivery) and the transmission inlet. This filter too must be replaced according to the schedule indicated by the Manufacturer.

The identification plate attached to each gearbox, further to product identification information, provides useful indications on the oil capacity of the gearbox pan, minimum operating pressure and oil check and change intervals.

**5.12.1 Maintenance of the gearbox**

Component	Maintenance	Notes and precautions
Gearbox	Oil level check	For the correct maintenance and check procedures, refer to use manual delivered by the Manufacturer.
	Oil change	For the kind of oil and grade of viscosity recommended by the Manufacturer, refer to the gearbox plate.
	Check and cleaning of the suction filter	
	Replacement of oil filter cartridge	Have the scheduled maintenance operations performed at the correct time schedule by authorized and skilled personnel, in order to keep the gearboxes perfectly efficient.



**CAUTION**

Under normal operation conditions, the gear change can be carried out with the engine at low speed. However, in case of emergency, gearshifting can be carried out with the engine at high speed, thus remarkably reducing clutch life though. The use of the gearbox with a low quantity of oil may damage the gears. An excessive quantity of oil may cause seals and vents to leak and can remarkably increase the operation temperature.



**CAUTION**

Check the oil level after filling the circuit idling. Make sure that the oil and water circuits are free of air pockets idling.

### 5.13 MECHANICAL SHAFT SEAL

The mechanical seal has the function of preventing seawater from entering the yacht through the space between the propeller shaft and the hull.

It consists of two rotating rings held in contact by combined forces.

One ring is defined as rotating and rotates with the shaft; the other stationary is fixed to the hull. The structure of the stationary part is made by the use of industrial techno polymers, which guarantee not to run into problems such as ageing or the possibility of drilling or fire.

The seal between the parts is made by means of O-rings.

The cooling of the seal is ensured by the access of water through the flushing duct.

#### Before starting the engine

- Make sure the seal is clean on the outside as well. If foreign bodies are present, it is recommended to wash thoroughly.
- Make sure that the flush water valve is open and there are no leaks from the sealing surfaces.

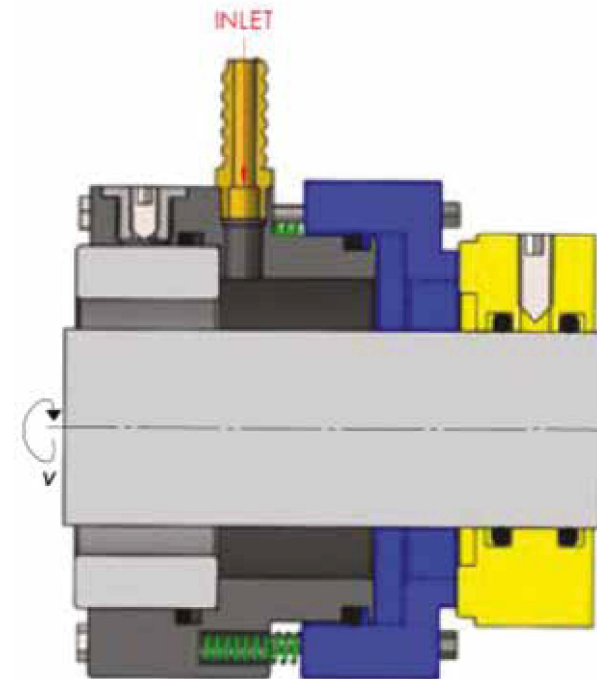

**DANGER**

Do not approach the shafts when they are rotating.



**CAUTION**

In order not to compromise the seal, it is essential never to operate it without cooling water.



**CAUTION**

Bleed the mechanical seals each time the yacht is hauled/launched.



**WARNING**

RIVA yachts are designed to have a correct transversal trim with full optional equipment, in the presence of propellers and shafts of respect. In case the yacht is not equipped with all the optional extras and with respect shafts and propellers, weights are inserted to compensate and make the trim correct.

**MAINTENANCE**

At least once a week, check that there is no water seepage.  
At least once a month carry out a cleaning.

Periodically:

- Check the condition of the seals;
- Check the compression of the seal and when necessary make a compression;
- Check and maintain the cooling circuit of the seals to prevent dirt, algae and foreign bodies from blocking the flow of cooling water, causing the seals to overheat and permanently damage them.

**NOTE**

For further information on use and maintenance, please refer to the manufacturer's manual.

1. Through-hull
2. O-ring
3. Stationary support
4. O-ring
5. Stationary ring
6. Rotating ring
7. O-ring

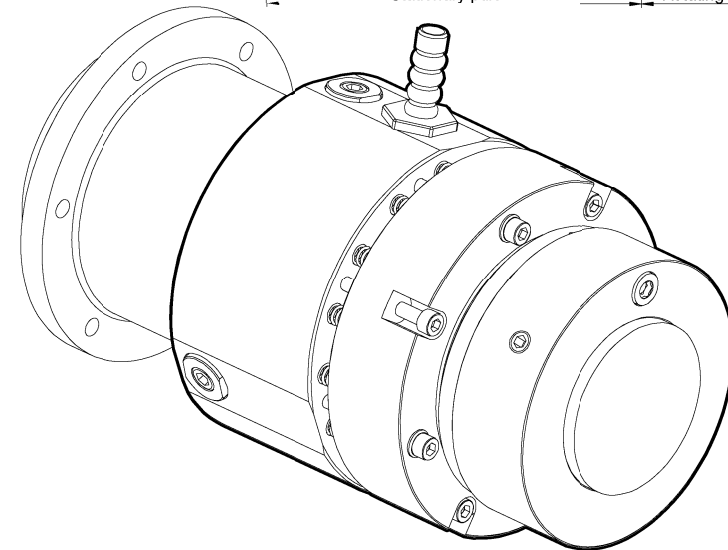
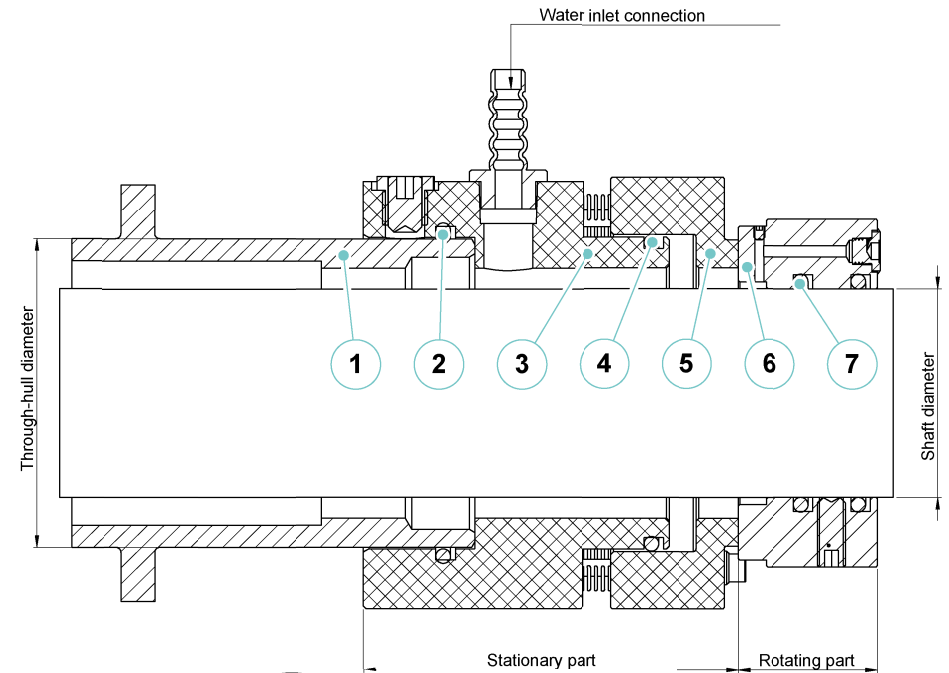

## 5.14 STEERING SYSTEM

The servo-assisted steering system was created to facilitate steering during navigation and to improve safety conditions of the system. It consists of two electrical units (1) that control each rudder (2) separately.

The steering system is controlled by the control helm position.

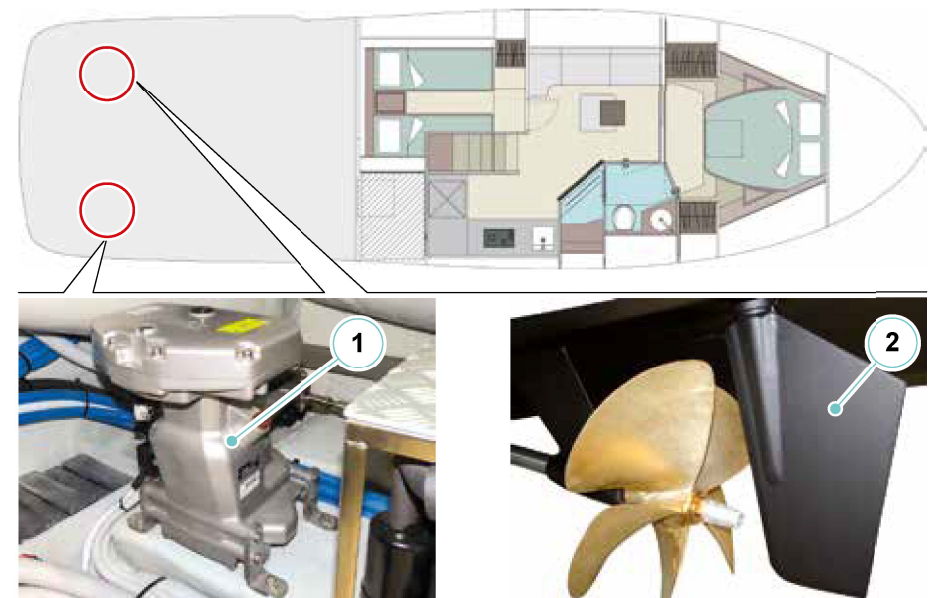

### 5.14.1 Steering system components

#### Steering system group

The steering system is situated astern the engine room and consists of:

- Electrical units;
- Arms linked to each rudder blade separately.

The automatic pilot sensor, which allows the automatic pilot-assisted navigation, is situated close to the port rudder arm.



#### CAUTION

The position of the sensor is adjusted by RIVA; tampering is not permitted by unauthorised staff.

#### Rudders' stroke check

- Power the system and start the electrical units.
- Bring the rudder to the centre.
- Turn the rudder wheel at one side, count the number of turns up to stroke end.
- Repeat the operation on the other side, then bring the rudder wheels in central position.
- The number of wheel turns must be about the same in both directions.



#### WARNING

Should you find remarkable inaccuracy or anomaly when testing rudder stroke, please contact the RIVA After Sales & Service Department.

**5.14.2 Maintenance of the steering system**

Component	Maintenance	Notes and precautions
Electro-hydraulic steering system	System diagram  Check the rudders stroke (at least once a month and anyway before each navigation)	For the proper maintenance and control procedures, refer to the user's manual supplied by the Manufacturer.

### 5.15 FUEL SYSTEM

The fuel system of your yacht consists of one tank located in a engine room behind the forward bulkhead, reinforced internally, certified and tested by RINA.

It is a single fiberglass tank compliant with the applicable law, resistant to fuel and corrosion, fixed to the bottom and side skeleton and with resining of the bow bulkhead of engine room; the total capacity is 1800 l (475,5 gal).

The engine and generator suction units are on the central door (2), from which fuel is picked up by utilities. All returns are on ceiling.

The fuel filler opening, through which the tank is filled in by gravity, closed by a screw cap, is situated on the starboard side (1). Fuel is filled through a watertight door on the tank ceiling.

The fuel coming out of the shipping duct is picked up in a container with the appropriate capacity which, in turn, will automatically leak into the fuel tank through a special reflux.

The three outlets of the tank are detected by solenoid valves. The fuel tank outlet is situated on the ceiling close to the port watertight door and discharges externally in two starboard and port points of the yacht.

The presence of condensate water in the tank favours the development of microorganisms in the fuel that cause premature filter clogging and corrosion damage. It is therefore necessary to drain condensate water from the tank and separate separator filters (engine prefilters (4), engine filters (3)) at regular intervals.

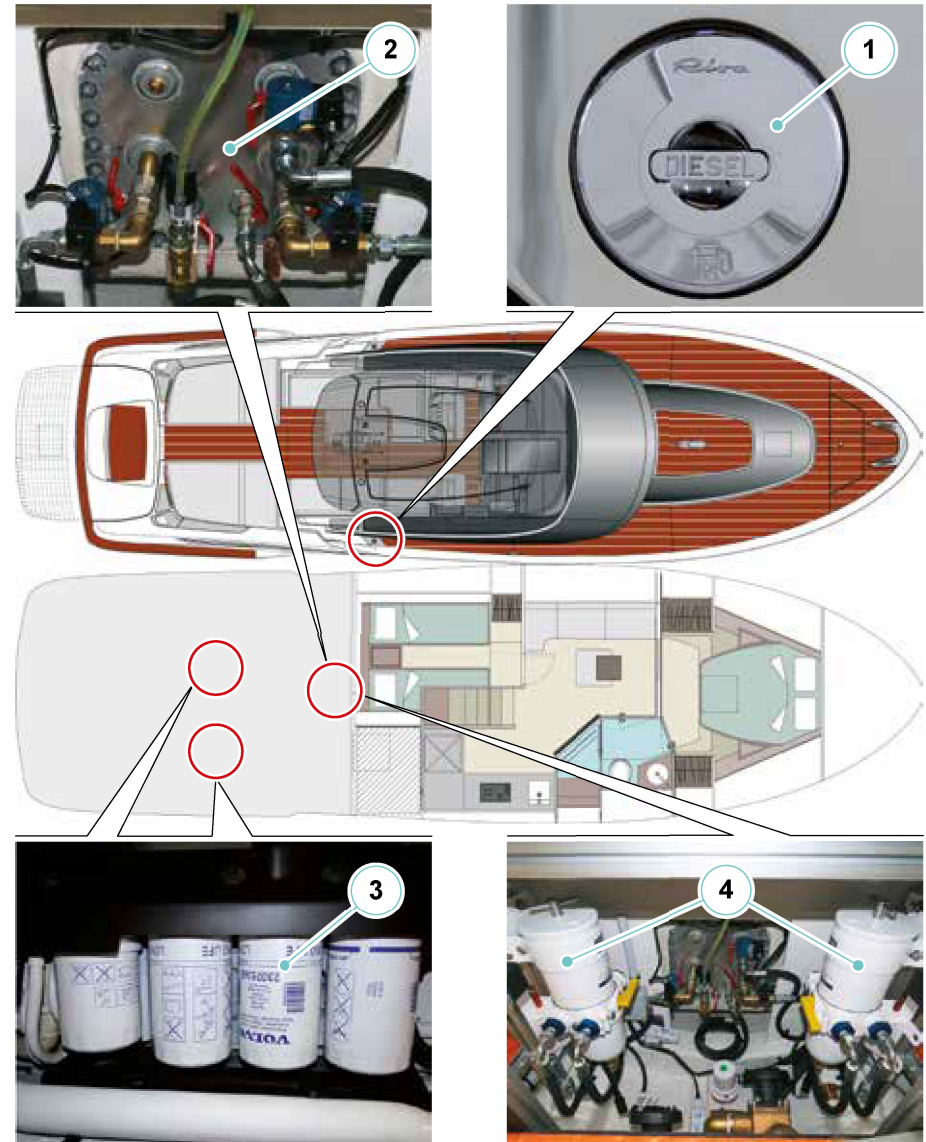

**NOTE**

We recommend filling the tank some hours before departure; in this way, the impurities and water in the fuel will decant on the tank bottom as they are both heavier than fuel.

The particular shape and arrangement of the tank eases settlement of possible impurities or water which may be present in the fuel; it is advisable to carry out tank drain, by means of the special air valve, a few hours after refuelling, and possibly while the yacht is stopped.

It is also advisable to connect the bleeding valves delivery to a hose, conveying the liquid into a bucket in order to avoid collecting flammable fuel in the bilge, thus preventing the formation of noxious exhalations.

**DANGER**

Because of the high temperature in the engine room, oil or fuel leaks can evaporate and create a serious risk of fire.  
Fuel leaks can cause fire. Regularly check the integrity of the system.

**ENVIRONMENT**

Handle water mixed with fuel and dispose of it according to the rules in force. Use only authorized disposal procedures and, in case of doubts, contact the Port Authority.

**NOTE**

While boarding, the fuel flow produces a lot of foam; if it comes out, you might think the tank is full.  
Therefore, it is good to wait for a few minutes and then top up, in order to be sure that the tank has been completely filled.

**CAUTION**

The inlet plug carries the indication "DIESEL" to avoid accidental input of different fuels.  
To avoid damage to the system and tank, we recommend replenishing by gravity and not by pressure.

### 5.15.1 Fuel circuit

The fuel inside the tank supplies the propulsion engines and the generators, by which it is sucked through fuel-resistant and fireproof pipes.

During the various passages of the fuel, before it reaches the engines, some natural phenomena occur, as the forming of condensate water, weed generation, breakaway of solid particles from the several containers in which fuel is transferred, which alter its propelling properties.

Most of the engine failures are due to these phenomena, water and solid corruptors, which irremediably damage pumps and injectors. For this reason, filters/separators have been installed for the propulsion engines, which the fuel contained in the tank must pass through before reaching the engine pumps.

The separator filters, besides performing an effective filtering action by retaining suspended impurities, are able to separate water that may be present in the fuel.

The separator filters, installed in the engine room near the fuel tank, are provided with a cup with bleeding valve in the lower part, which allow bleeding both water and impurities.

Inside the cup there is a sensor, which sends an alarm signal to the helm position when the water level is excessive and system bleeding is necessary. The yacht is also equipped with separator filters, which have the same effectiveness characteristics of engine filters and ensure further purification of the fuel sucked by the engines.

The filtered fuel, sucked by the fuel pumps, reaches the engines through the delivery ducts.

The excess fuel, which cannot be burnt by the engines, is drained again into the fuel tank through the return ducts.

The fuel suction points of the propulsion engines are detected by solenoid valve controlled automatically during opening and closure when the engine is started and stopped.

Also the generator set is directly supplied by the tank, with manual cut-OFF valve, solenoid valve (automatically opened and closed during generator set start up and shut down) and separator filter.

The solenoid valves for fuel oil supply to the engines (propulsion and generator) are controlled when closed by the fire-fighting system control unit, in case of a fire, it stops all engines and prevents them from supplying fuel. Please refer to Chapter 2 – “Safety regulation and equipment” in this Manual.



#### CAUTION

Pay attention not to accidentally damage fuel system lines.  
Check all pipes periodically.

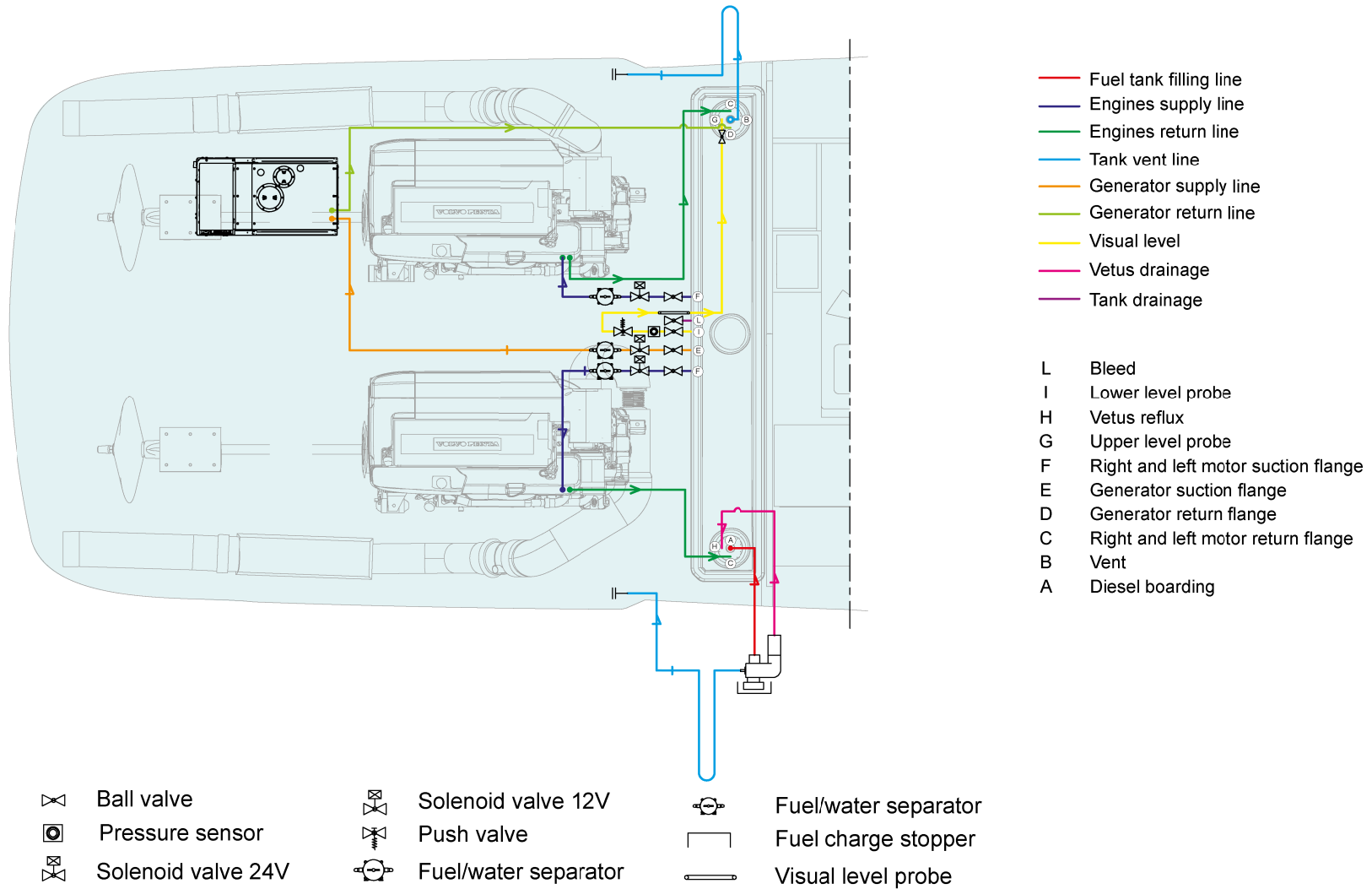

### 5.15.2 Fuel quality

The quality of the fuel is crucial for a good performance of the engines installed on your yacht. The fuel should be purchased from reliable high volume filling stations, for both the quality and a probable short stay of the fuel inside the shore tank.

The fuels preferred and suggested by the manufacturer adequately provide for engine correct operation and maintain its high performance. This fuel is commonly known as “Diesel fuel” or “gas oil”.

Fuels compliant with:

- European Standard EN590
- DIN EN 590 (Germany)
- ÖNORM EN 590
- ASTM D975 No. 1D (USA)
- BS 2869 Part 1 Class A 1 (United Kingdom)
- BS MA 100 DMX (Marine Diesel Fuel)

are suitable to supply the engines.

The use of fuel other than the type suggested and recommended by engine Manufacturer may cause the following problems:

- Difficult start up;
- Poor combustion;
- Formation of deposits in injectors and in the combustion chamber;
- Engine and fuel supply system service life reduction.

Micro-organisms (bacteria, fungi) contained in fuel can reproduce in favourable conditions. Growth of micro-organisms is favoured by water, present in all fuels as condensate, and elements fundamental for life such as sulphur, phosphorus, nitrogen, oxygen and trace-elements to be found as chemical bonds.

Also possible additives may contribute to micro-organism growth.

Proliferation speed depends on temperature and leads to the formation of fibrous fungi suspensions, mud or to micro-organic corrosion.

The consequence of this process is the obstruction of the fuel filters with rust scales and fibres. The first symptom of these phenomena is frequent replacement of the fuel filter and afterwards engine performance drops until its total standstill.

If you notice the presence of micro-organisms in the fuel feeding system, it is necessary to use proper detergent products suggested by the engine Manufacturer according to the procedures stated.



**DANGER**

Stop all on-board engines during the refuelling process.  
Avoid undertaking hazardous activities.

**5.15.3 Fuel system maintenance**

Component	Maintenance	Notes and precautions
Fuel tank	Bleeding	<p>Bleed the tank every 2 refuellings and at least once a month, in order to prevent condensate water and various impurities from entering the fuel circuit. Wait some hours from refuelling to allow impurities and water to deposit.</p> <p>Do not discharge bilge water containing bleed fuel into the sea, but collect it and discharge it to the appropriate areas on land for hydrocarbon disposal.</p>
Separator filters	Cleaning and purging	<p>Bleed the separator filters at least once a month in order to drain condensate water and various impurities collected in the special lower cup. Periodically replace the filtering element, increasing frequency if necessary.</p>

#### 5.15.4 Bleeding of separator filters

The separator filters are provided with a cup, in the lower part, provided with a bleeding valve, which allows bleeding the water and impurities decanted on the bottom of the cup.

For the single filter separator bleed see its specific documentation.

#### 5.15.5 Separator filter cartridge replacement

Separator filters are equipped with internal filtering cartridges which retain impurities, preventing them from entering the engine fuel circuit.

For the internal filter element exchange see its specific documentation.



#### ENVIRONMENT

Every marina has dedicated toxic waste disposal areas. Do not dispose into the environment waste, which may cause environmental damage (such as used oil, fuel oil, oily liquids, batteries, etc..).

Prior to performing any job in the engine room, disconnect the bilge pump switches, to prevent accidental fuel, lubricant or other liquid leaks and therefore the pollution of the waters surrounding the yacht.

#### 5.15.6 Bleeding of filters

The yacht also has separator filters, which ensure a further purification of the engine's aspirated fuel.

The filters are provided with a transparent cup, in the lower part, provided with a bleeding valve, which allows bleeding the water and the impurities decanted on the bottom of the cup.

Cleaning / replacement of the filter element see its specific documentation.

## 5.16 SEAWATER COOLING SYSTEM

For the cooling of the propulsion engines and the generator, sea water is used, which is sucked directly from the internal centrifugal pumps of the engines.

These pumps, by means of their heat exchangers, cool down fresh water in the internal cooling circuit by absorbing transported heat.

Many waters (harbors, rivers, coastal) contain sand and suspended matter.

In order to avoid the clogging of the heat exchanger and the intercooler, and to increase the durability of the engine cooling pump, each outlet to the sea is equipped with strainer for the external water and with shut-off for maintenance valve. Before entering into the heat exchanger, the cooling water passes through the intercooler to the charge air cooler.

The cooling sea water drawn in by the engine is sent subsequently to the inverters, for lubricant oil cooling.

The sea water for cooling the generator, the air conditioning unit and the gyroscopic stabilizer, enters through the water intake placed on the bottom of the hull and protected by the grids.

1. Generator sea water intake
2. Gyroscopic stabilizer sea water intake (optional)
3. Air conditioning sea water intake
4. Fire-fighting sea water intake
5. Engines sea water intake

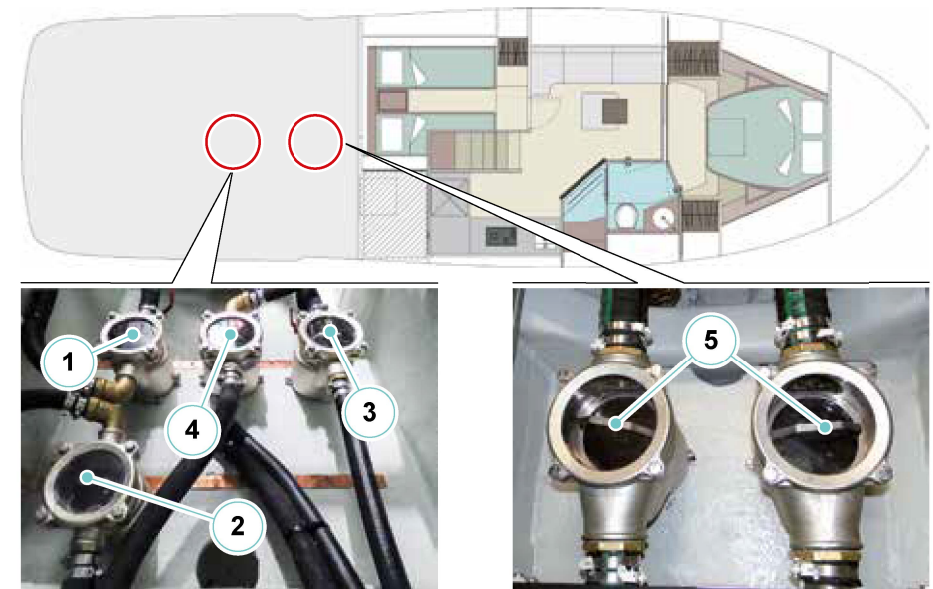

The cooling water that is injected inside the ducts the exhaust is discharged overboard through the latter route.

The cooling water that is sent to inverters, once the lubricating oil heat absorbed, is conveyed in the exhaust of engines.

There is the possibility, in case of emergency or necessity, of removing large masses of water, if present in the bilge of the engine room, using the aspirations of the engine cooling circuit.

For this operation, refer to “Intake emergency engines from the bilge”.









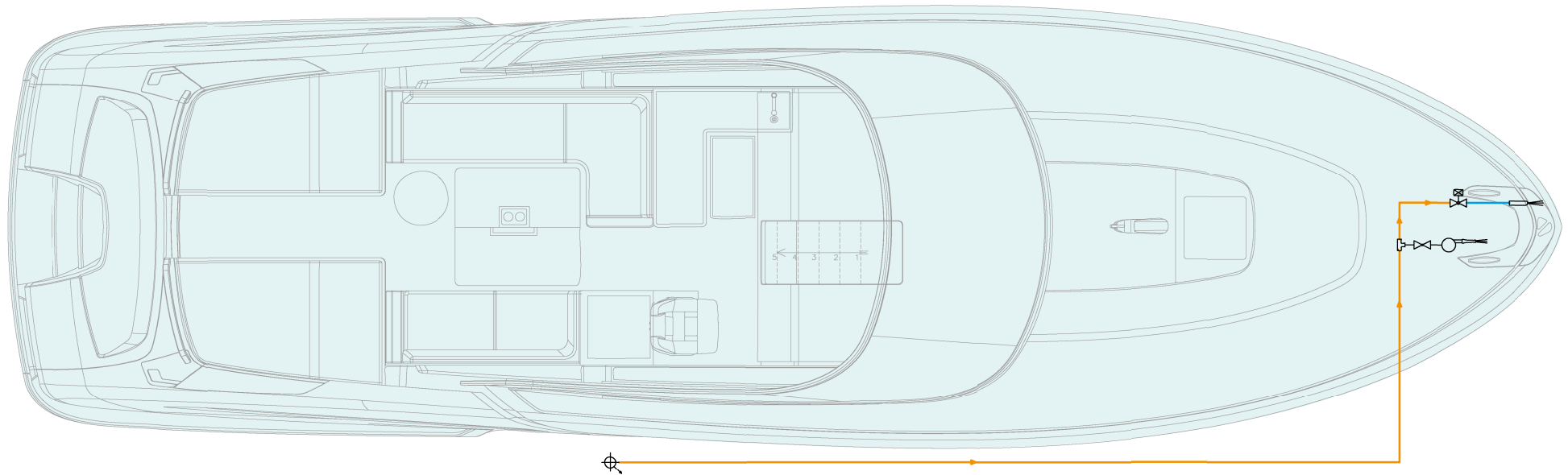











**CAUTION**

Before opening the sea cock strainer for cleaning, remember to close the cut-OFF valve in the hull.

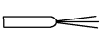







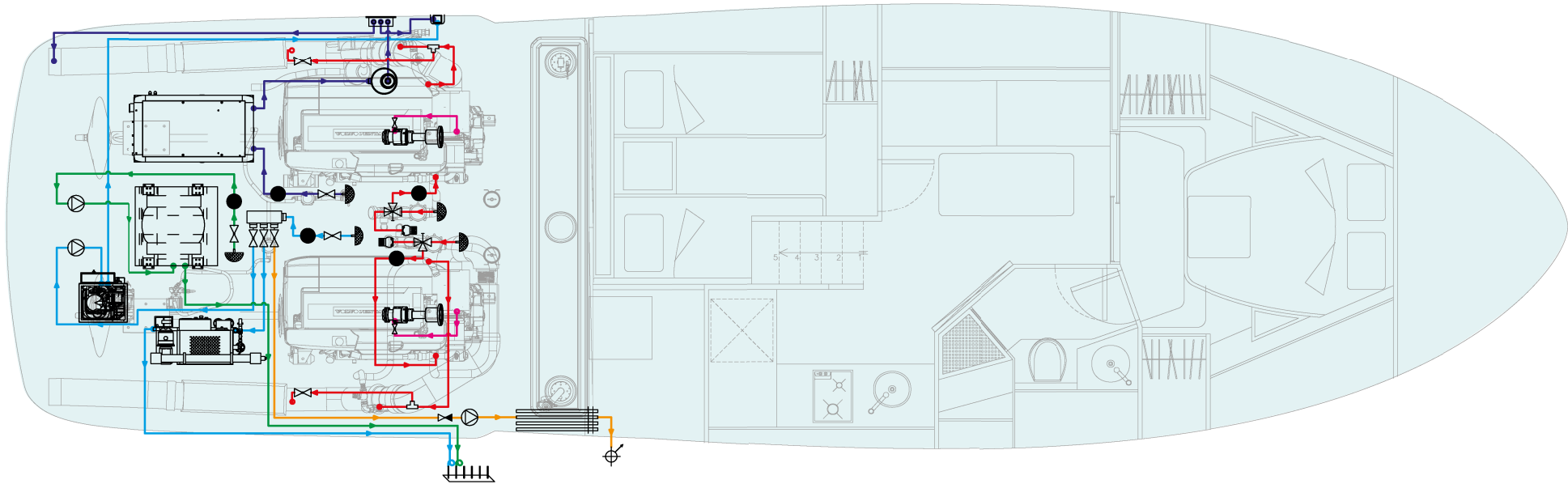

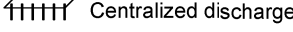







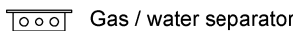

If the yacht is not used, close as a precaution, all cut-OFF valves of the sea cocks; as soon as the yacht is reused, remember to open them.

## Sea water system diagram



- |   |   |   |   |
|---|---|---|---|
|  Ball valve                              |  Centralized discharge |  Chiller unit                        |  Stabilizer sea water cooling pump |
|  Threaded seachest valve                 |  Foot valve            |  Watermaker (optional)               |  Spring check valve                |
|  Strainer                                |  Muffler               |  Fire hose with nozzle and fittings  |  Engine seawater line              |
|  Sea cock                                |  Gas / water separator |  Chain washing                       |  Generator seawater line           |
|  Sea water air conditioning electro pump |  3 way manifold        |  Sea water distribution electro pump |  Services seawater line A/C        |
|   |   |   |  Fire fighting seawater line       |



- |   |  |   |  |
|---|--|---|--|
|  Ball valve                               |  Centralized discharge  |  Chiller unit                         |  Stabilizer sea water cooling pump |
|  Threaded seachest valve                 |  Foot valve             |  Watermaker (optional)               |  Spring check valve               |
|  Strainer                                |  Muffler                |  Fire hose with nozzle and fittings  |  Engine seawater line             |
|  Sea cock                                |  Gas / water separator |  Chain washing                       |  Generator seawater line          |
|  Sea water air conditioning electro pump |  3 way manifold         |  Sea water distribution electro pump |  Gyroscope stabilizer line        |
|   |  |   |  Services seawater line A/C       |
|   |  |   |  Fire fighting seawater line      |

## 5.17 ENGINES EXHAUST SYSTEM

The engine exhausts are underwater and located at the stern sides of the yacht. This system reduces the smoke that usually tends to soil the yacht's stern.

Exhausts must be maintained and checked at regular intervals to avoid the formation of build-ups that could prevent the correct gas ejection.



### WARNING

When starting the engines, check that water comes out of the exhaust; this means that the engines cooling system works correctly and that the exhaust is cooled. Accelerate if no water comes out. If the problem continues, contact RIVA After Sales & Service Department.



### CAUTION

A strong smell and a light smoke from exhaust insulation **(1)** are normal during the first period of use.

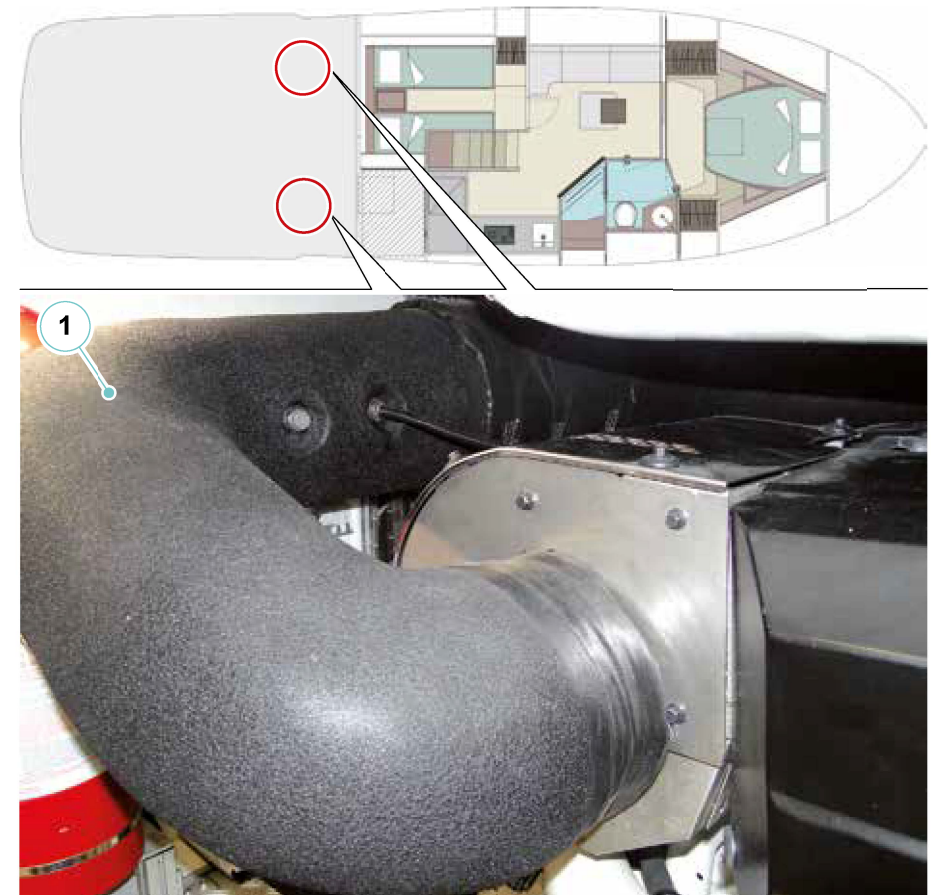

*Riva*

Engine exhaust diagram

DOLCERIVA

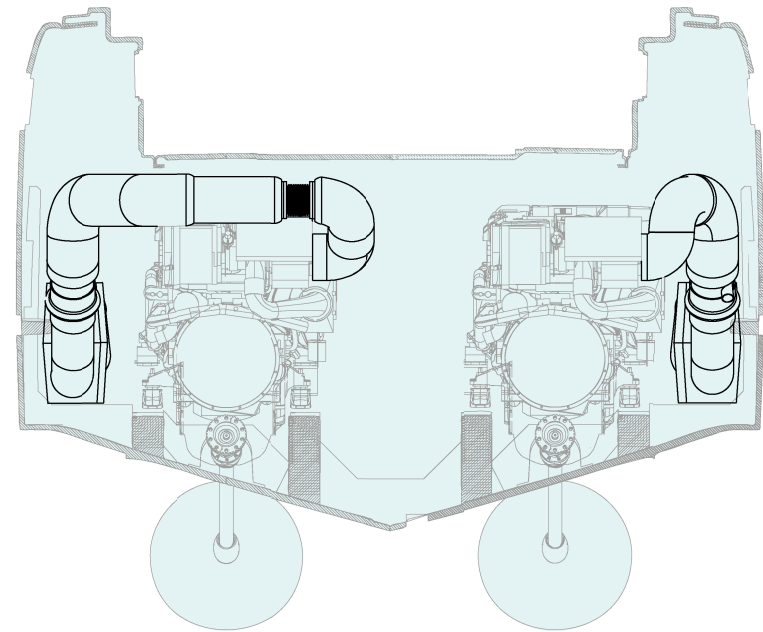
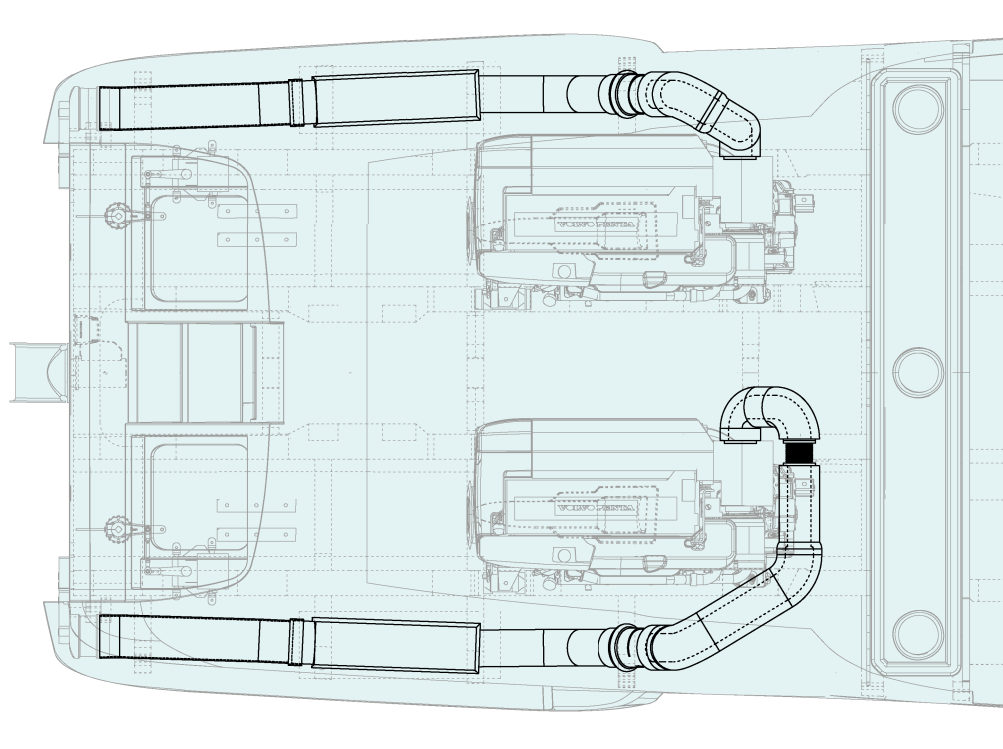

5.17.1 Maintenance of the engine exhausts

Component	Maintenance	Notes and precautions
Exhausts	Periodical check (as necessary, according to the floating area)	<p>Check the underwater exhaust terminal cleanliness conditions periodically. Clean, if necessary.</p> <div style="border: 2px solid yellow; padding: 10px; text-align: center;">  <p><b>CAUTION</b></p> <p>Carbon deposits, marine growths and fouling may affect the engine regular operation, causing performance degradation and serious damages.</p> </div>

**MAINTENANCE**

At least once every three months carry out the tightening of the discharge raiser bolts.



**CAUTION**

Some temperature sensors have been installed on both engine exhausts, the warning lights are visible on the engine control panel in the helm position and they light up to indicate that the temperature inside the exhausts is too high.



**DANGER**

**Carbon Monoxide poisoning hazard**

Ensure that the engine exhaust system operates correctly. Carbon monoxide is extremely toxic. The exhaust system removes the combustion gas created by the engine and allows the correct ventilation of the stern. Inspect the system tightness on a frequent basis. Leaks may permit carbon monoxide exposure.

## 5.18 ENGINE ROOM VENTILATION SYSTEM

During operation, due to their surface temperature, the engines propagate radiant heat, which must be eliminated through efficient ventilation. Air inlet and discharge openings are positioned so as to have the air flow passing through the whole room.

The yacht's diesel engines (propulsion engines and generator) suck combustion air directly from the engine room. Therefore, an efficient ventilation system prevents an excessive air and fuel heating, and thus avoids harmful power drops and does not jeopardise the operation of heat-sensitive components.

The external fresh air enters the engine room and the utility room through two inlets (air intakes **(2)**) located on the bulwark on both sides of the yacht.

The air extraction is of the forced type, by means of three air extractors **(1)** (sucking fans) which extract the hot air from the rooms.

The extractors are automatically started when the engine ignition keys are started.

To start the air extractors in manual mode, press the start/stop button on the helm position.

The power supply of the extractors is controlled by the SHUTDOWN system of the fire fighting system that, in case of automatic fire extinguishing system activation, or when operating the tie rod, shuts down the air extractors in order to prevent air change in the room (see "Fire fighting system").

### NOTE

With the engines in operation the extractor must always be switched ON. The extraction remains in operation for a few minutes after engine shut-down (auto mode).

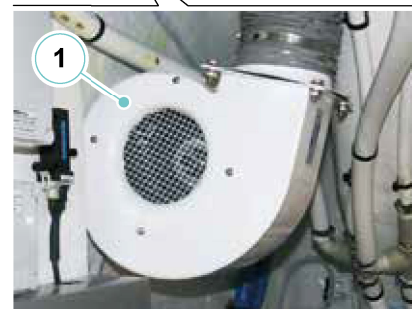
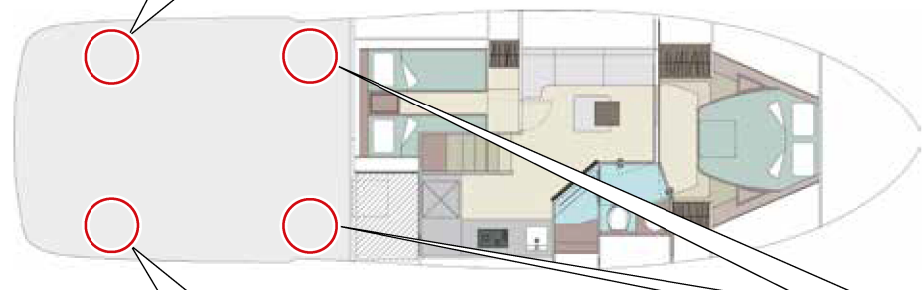
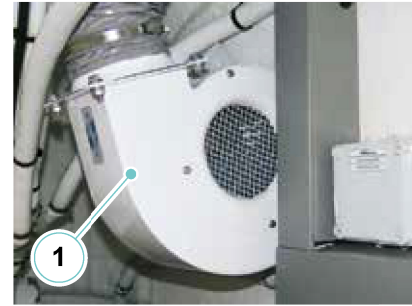

**CAUTION**

Do not lay tools or clothing on the extractors or on the air inlets.

**DANGER****Carbon monoxide poisoning**

Fossil fuel combustion generates a high quantity of carbon monoxide. This gas is a colourless, odourless and highly toxic. When the engines and/or the generator are running, the yacht must be properly ventilated, in particular if underway at low speed, or when the exhaust fumes may blow back on board (e.g. when the yacht is shored or anchored or riding the anchor).

**CAUTION**

Do not accidentally obstruct the external grate **(1)** with any objects (such as stretched sheets, etc..).

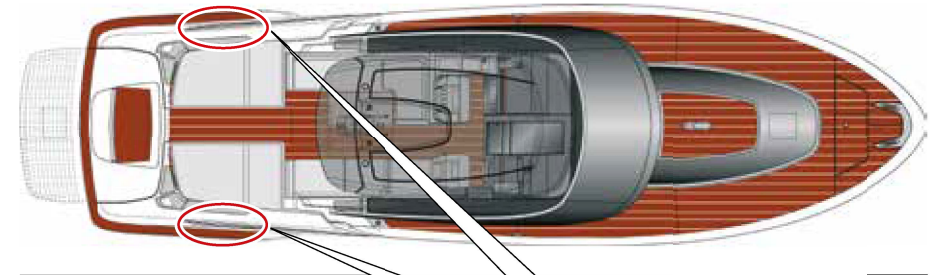

Engine room ventilation system diagram

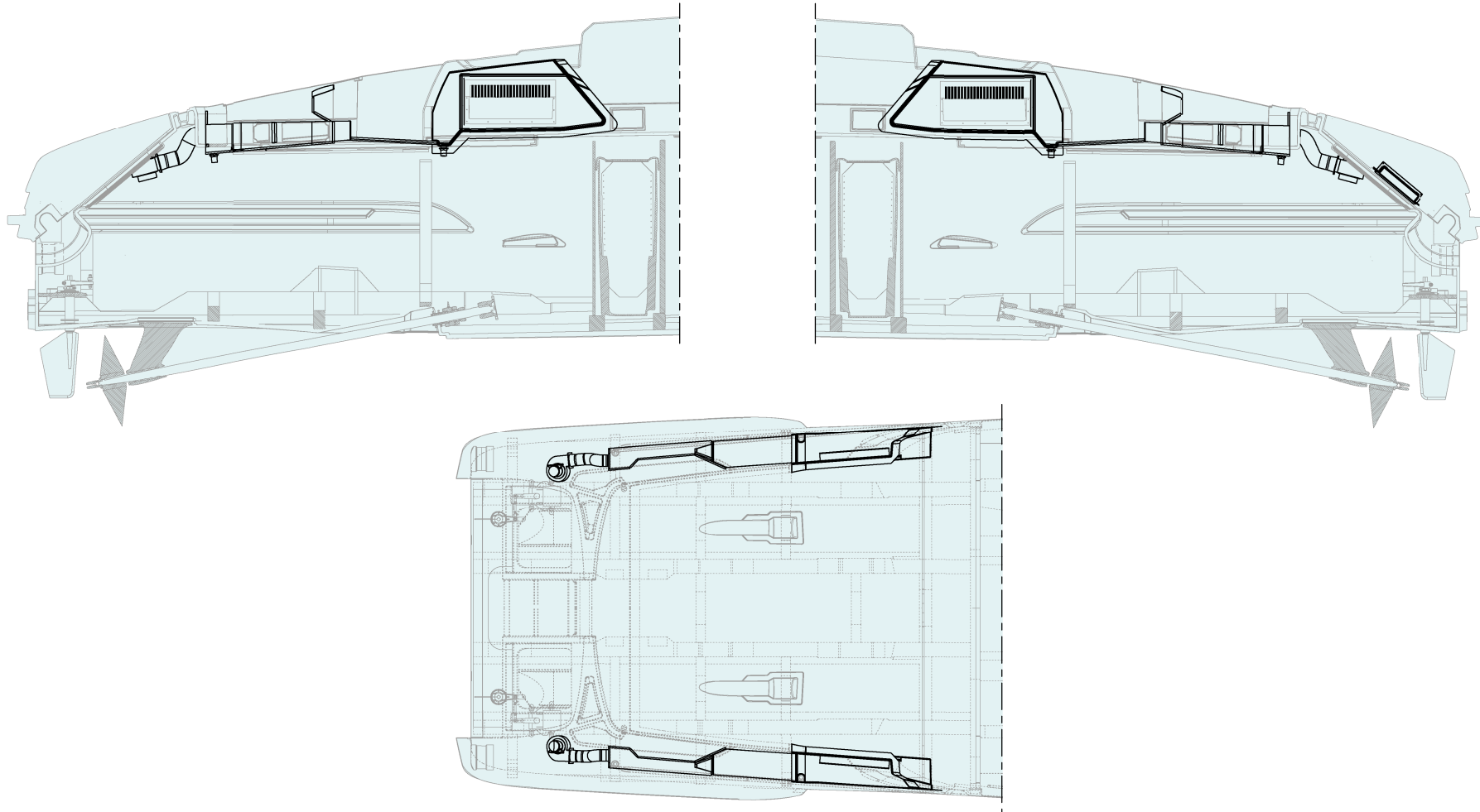

## Guest's area ventilation diagram

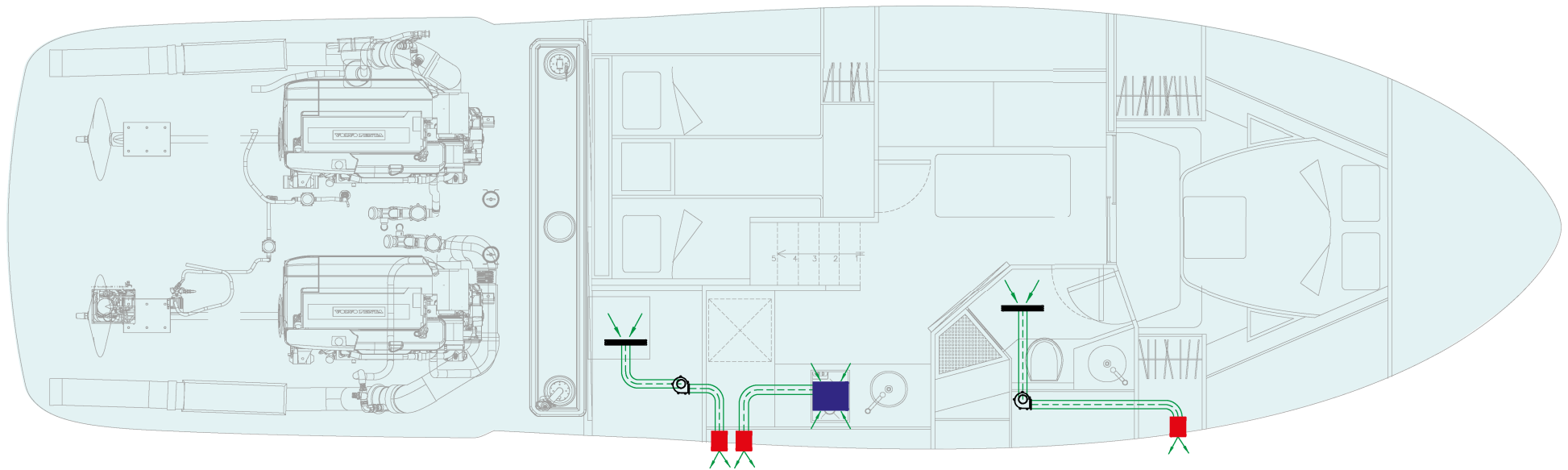

 Extractor

 Extraction output

 Suction grid

 Kitchen hood with extraction fan

## 5.19 CATHODIC PROTECTION SYSTEM

Immersed metal parts as steel, bronze, etc..., are protected against galvanic corrosion by sacrificial anodes installed on the bottom hull and on the appendixes, close to the areas to be protected.

Corrosion is caused by galvanic currents resulting from the proximity of metallic bodies with different electrochemical potential, immersed, in this case, in the electrolyte: sea water, in this case.

Protection against corrosion is obtained by connecting a noble metal to a less noble one; in this way, the noble metal (steel) is protected by an electron flow supplied by the less noble metal (aluminum), that wears out.

The cathodic protection system of the yacht consists of the following sacrificial anodes:

1. Generator anode (n°1);
2. Bow thruster anodes (n°2);
3. Ground strip anode (n°4);
4. Transducer (n°1);
5. Propeller anodes (n°2).

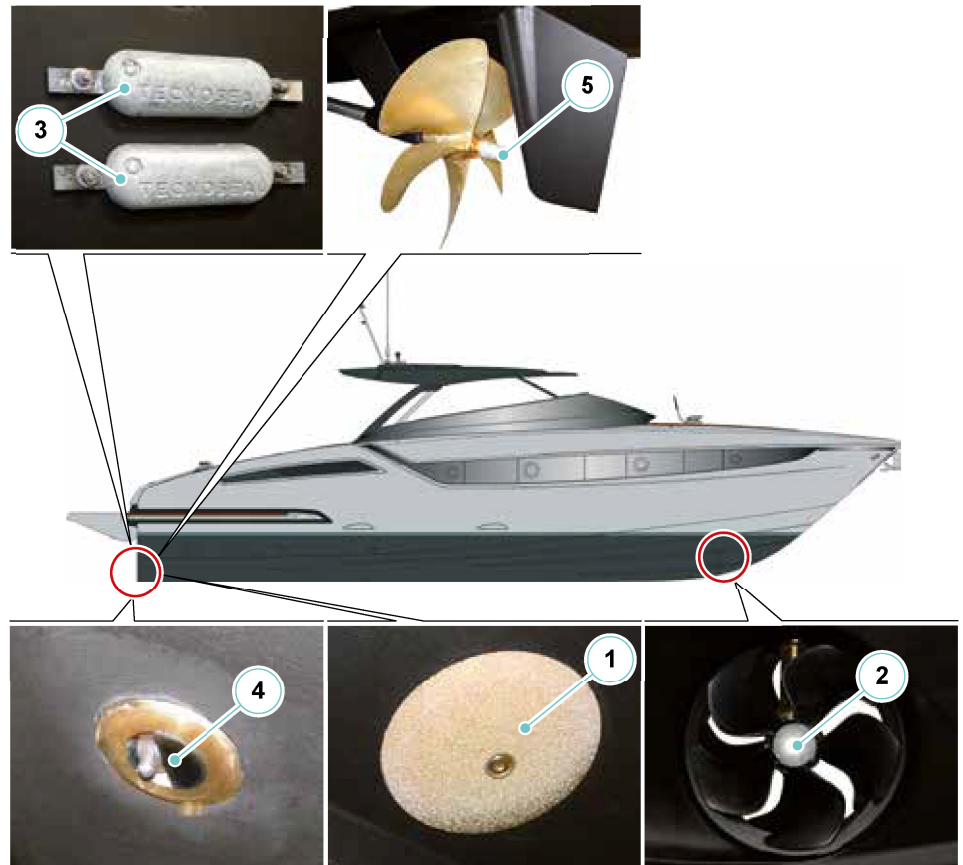

The wear of the sacrificial anodes, besides depending from galvanic currents, can also be caused by environmental factors in the proximity of the yacht, such as: closeness to other metallic bodies, chains, metallic wharfs, bad insulation of on-land electric systems, different water salinity, etc..

It is therefore necessary to check the status of the sacrificial anodes very often.

The replacement is necessary when the wear is higher than 50%.

This operation must be carried out with yacht on dry shore or with the help of a diver.



**CAUTION**

Whenever the yacht must be lifted, verify the condition of each protective sacrificial anodes and its fastening system.

In order not to jeopardise the protection's effectiveness, the sacrificial anodes must never be coated.

To clean or check the yacht in water, disable engine and generator start.

**5.19.1 Maintenance of sacrificial anodes**

Component	Maintenance	Notes and precautions
Sacrificial anodes	Periodical check	Frequently check the sacrificial anodes' wear conditions; replace them when the volume is reduced by more than 50%.
	Replacement	Loosen the anode fastening nuts, extract the anode and clean the resting surface. Assemble the new anode, tighten the fastening nuts and cover the screw head with silicone.

**5.19.2 Replacement of anodes**

Check the wear conditions of sacrificial anodes; they must be replaced if they show evident signs of corrosion or when the volume is reduced by approximately 50%.

After disassembling the worn-out anode, clean the resting seat and replace with a new anode, tightening the mounting nuts.

It is advisable to cover the mounting screws' heads with silicone, in order to ease their replacement.

It is advisable not to tighten the mounting nuts with glues or other materials which may prevent their removal.



**CAUTION**

Make sure not to cover the contact surface between anode and hull, in order to ensure effectiveness of sacrificial anodes' action.

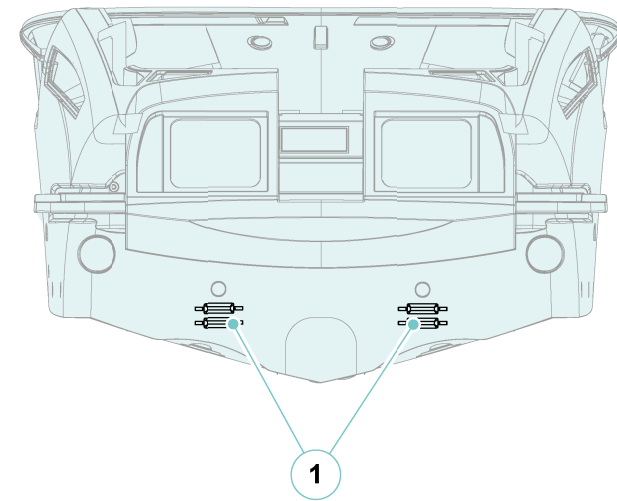
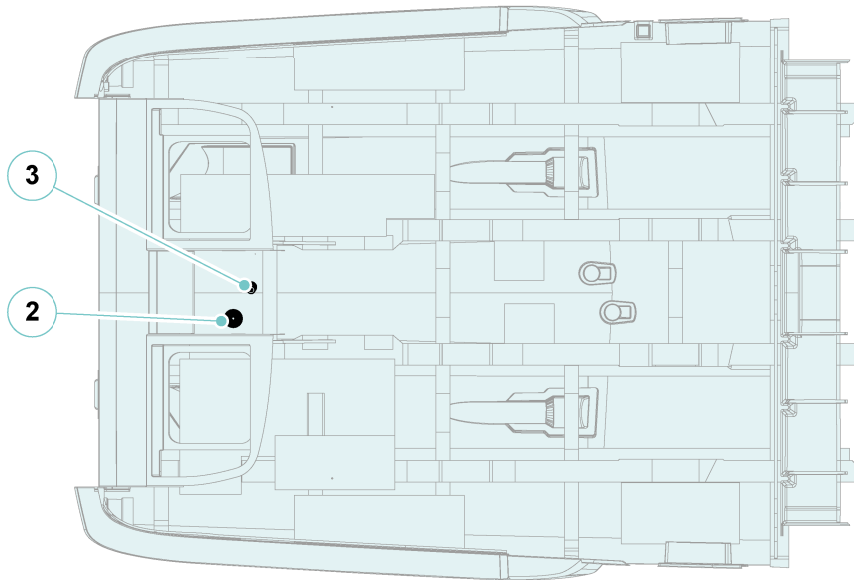

- 1. Oval anode with insert
- 2. Circular mass plate
- 3. Transducer





*Riva*

DOLCERIVA

6 - INFORMATION FOR USE

## 6.1 GENERAL INFORMATION

This part of the manual describes the operations and behaviour to be adopted in the various situations that you may face during navigation. Generally speaking, there are some basic rules always to be taken into account, so as to enjoy your yacht with maximum safety.

- Periodically check the availability and efficiency of individual and collective safety equipment.
- Observe safety distance when anchoring.
- Check that all yacht safety equipment on board are in good conditions and no maintenance activity is overdue. The Manufacturer supplies the equipment required by the international regulations; the Owner is responsible for the provision of any safety devices required by national regulations of the Country in whose waters the yacht is navigating.
- In case of use of portable fire extinguishers lower deck, use the same precautions mentioned above.
- Do not use open flames nor smoke during transfers or next to fuel and lubricant.
- If a fixed HFC227 fire-fighting system is used, do not ventilate the engine room for a certain time, until the fire has been completely extinguished. Before entering the room again, it is necessary to ventilate it.
- When operating the gangway, be sure that nobody is in the way.
- Oils, used filters, emulsions, coolants, electrolytes are all harmful products: avoid contacts with the skin and dispose of them carefully.
- In the engine room, pay attention to hot or moving parts.
- Access the engine room wearing individual protecting devices such as: antinoise earmuffs, gloves, etc..
- Do not scatter hydrocarbons in the environment.
- Frequently replace the fresh water stored in the tanks and apply bactericides as needed.
- Do not exceed speed limits in harbour and confined waters.

- Adjust speed according to sea conditions.
- Reduce speed in proximity of other yachts or swimmers. If necessary, put the engine control levers to neutral.
- Reduce speed before accessing the engine room if, at that time, you are the only available pilot.
- Handle hot oils carefully, in order to prevent serious burns.
- Secure engines, shaft lines and generators prior to perform any maintenance on them.
- Open the coolant tanks of the different engines very carefully, in order to prevent serious burns.
- Do not inhale exhaust fumes.
- Do not work on generator electrical panels when the generator is running: electrocution hazard.
- Before disconnecting a battery, check if the battery charger is operating. If it is, disconnect it and remove the negative wire first and then the positive one. When reconnecting, proceed in the reverse sequence (the positive wire first and then the negative one).
- Immediately service any part showing signs of corrosion.
- Never disconnect the batteries when the generator or the propulsion engines are running.



**DANGER**

The Owner is the sole responsible for driving the yacht.  
Prior to departure, the Owner must ensure that the safety equipment required by law is present on board and perfectly working.



**DANGER**

Before starting navigating and before operating the different on-board systems, we recommend carefully reading the Safety Rules for use described in this Manual.

## 6.2 PRECAUTIONS FOR HARSH CLIMATES

### 6.2.1 Cooling system

When temperature approaches 0°C (32°F), in order to avoid damage due to freezing, it is necessary to make sure that the engines' internal circuits are filled with antifreeze mixture.

Otherwise replace coolant with a mixture of water (drinking, demineralised or distilled) and antifreeze in variable proportions. Before filling the system with the suitable antifreeze mixture, it is necessary to wash out the cooling circuit.

The antifreeze liquid is recommended for all climates: besides having anti-corrosion properties, it widens the operation temperature range of the engines for which it is used, by lowering the freezing point and rising the boiling point.

The cooling systems of the engines should be filled, all the year long, with a mixture of 60% water and 40% antifreeze, so as to grant a protection against corrosion and frost down to -27°C (-16,6°F).

At the beginning of the cold season you will have to check and rise the anti-freeze contents inside the cooling liquid according to the foreseen external temperatures.

#### NOTE

For information concerning the type of anti-freeze or additive to be used, please refer to the technical documentation supplied by the Manufacturer.



#### CAUTION

Do not use only water as a cooling liquid, as it is corrosive at the engine operating temperatures and does not protect suitably against boiling and freezing.



#### CAUTION

We recommend you to use technical liquids approved by the system Manufacturer.  
Always avoid antifreeze concentration to drop below 40% in volume.  
Replace the whole cooling liquid according to the schedule indicated by the Manufacturer.



#### ENVIRONMENT

Concentrated coolant must be treated as special waste.  
When disposing of used cooling liquid, keep to prescription of Authority locally in charge.

### 6.2.2 Fuel system

With low temperatures, Diesel fuel forms some solidified paraffin suspensions obstructing the fuel filters; in this way the normal engine supply is impossible.

The fuel as per European standard EN590 guarantees fluidity up to 0°C (32°F) during the summer period, and up to -20°C (-4°F) during the winter period.

#### NOTE

There is a special type of fuel for the countries subject to very low temperatures.

In case fluidity is low or if the temperatures are below -20°C (-4°F), we suggest you to mix fuel with specific additives using the percentages prescribed by the Manufacturer.

In extreme temperature conditions (down to -54°C [-65°F]) it is necessary to use specific fuel, complying with engines' operating requirements.

#### NOTE

For information concerning the type of fuel or additive to be used, please refer to the technical documentation supplied by the Manufacturer.



#### CAUTION

Periodically check that all devices cooled with water are filled with the correct quantity of anti-freeze.

Each time the outer temperature drops below 0°C (32°F), the (fresh or sea) water inside the ducts may freeze and consequently cause breaks. All the systems and equipment containing water, both sea water systems (engine cooling system, generator cooling system, etc..) and fresh water systems (windscreen wipers, fresh water pump, etc..) run this risk.

## 6.3 PREPARING FOR NAVIGATION

### 6.3.1 Preliminary checks

Accurate preliminary checks carried out with time, are fundamental for a safe navigation. Some important elements to be taken into account when preparing for departure are listed below:

- Gather information on weather forecasts and warnings concerning the course to be followed;
- Verify the presence of documents and certificates to be kept on board during navigation;
- Consult the pilot book for details about the area you want to reach;
- Consult the navigation charts, in particular the distance, routes, dangerous sea bottoms and shallow waters;
- Calculate the quantity of fuel necessary for navigation, adding a stock fuel quantity;
- Consider the length and duration of the cruise;
- Check that the safety equipment on board is efficient, in a good condition and corresponding to the regulations of your destination;
- Check for the correct operation of the yacht's bilge pumps, which are basic for water drain in case of flooding; remember to activate the magneto-thermal switches on the secondary electrical panel, which allows the bilge pumps to start automatically;
- Check the cleanliness of the sea water filters, essential for engines' and generator cooling, and for air conditioning and service feeding; in case they are dirty, it is necessary to close the sea water intake valves, by turning them in position perpendicular to the pipe, remove and clean out the frames, re-insert them and carefully close the strainers, then open the sea water intake valves again;



#### CAUTION

Once the hull valves have been reopened, make sure that no leaks are present.

- Check the tension of engine V-belts; if necessary, reset correct tensioning;
- Check oil level inside engines, gearboxes and generator; if necessary, top up;
- Check the coolant level inside engines and generator; if necessary, top up;
- Check the cleanliness of fuel air traps in the fuel system; in case of water presence, drain by means of the special tap;
- Check hydraulic oil levels on gangway; if necessary, top up;



#### CAUTION

For checking fluids and for topping-up, please refer to the specific manuals supplied by the Manufacturers.

- Check liquid levels (fuel, fresh water) in the tanks;
- Check that everything necessary to take the sea has been loaded on-board (provisions, nautical charts, documents, signal rockets, first-aid kit, etc.);
- Check the proper fastening of all mobile components, on the main deck and lower deck;

- Check that the load distribution is such as to maintain the right trim of the yacht; storage of the galley and of other materials can change the trim, particularly the transversal trim: distribute the load evenly and secure it properly to avoid sudden movements;
- Create a checklist of safety equipment, as indicated hereinafter;
- Check that the life jackets are in good conditions and that they are stored where required and anyway easy to reach (avoid putting obstacles of any kind in front of access hatches);
- Check that the life raft is easy to access and that the holding line is in a good condition;
- Make sure that the life buoy is in its correct location and provided with the relevant line and light-emitting buoy;
- Check the charge status of the extinguishers: the extinguisher is charged when the pressure gauge indicator is in the green sector.

**DANGER**

The yacht's Owner must make sure that all passengers are perfectly aware of safety equipment (fire extinguishers, life raft, life buoy, etc..) location and use.

**DANGER**

Safety equipment should always be checked before each navigation, in order to ensure the good condition of the safety devices and to become familiar with their location and use. The little time necessary for this task can result very useful in case of need.

**6.3.2 Operation tests**

- Check the operation of the rudder (move it from end to end, check its correct operation, then return it to central position).
- Check interceptor operation.
- Operate both the interceptors. If not in use, the interceptors must be kept raised.
- Check navigation lights and horn operation.
- Check the efficiency of the anchor winch and chain stopper.
- Verify the efficiency of the instruments (plotter, VHF, depth sounder, compass).
- Check for the proper closing of portholes and hatches.
- Check operation of bilge pumps and relevant indication lights.
- Lighten moorings, ensuring no obstacle can hinder unmooring operations (not aligned cables, chains, anchor log engaged in other boats moorings, etc..).
- Check that the engine room extractors are operating.
- Ensure no flammable or other improper materials have been stowed in the engine room.
- Check that the sea water intake valves for cooling engines, generator, air conditioning and fire-fighting system are open.
- Check that the cooling systems of engines and generator are operational (valves open).
- Ensure engines and generator fuel circuits are operational (open valves).
- Start the generator and, after a few minutes of pre-heating, give the electric charge to the generator by activating the utilities from the main control panel.
- Disconnect the shore plugs and cables.
- Connect the engine battery breakers.
- On the main electrical panel in the main helm position, check the battery charge status and, if necessary, recharge them.
- Connect the 24V utilities on the electrical panel.

- Switch off unnecessary uses, after checking their proper operation.
- Start the engines with the inverters in “neutral position”.

**CAUTION**

The battery charger must be turned OFF with the engines running.

**6.3.3 Start of propulsion engines**

Before starting the new or overhauled propulsion engines for the first time, carefully read the technical documentation supplied by the Manufactures. During the first operating hours, we recommended that the engines not be run at more than 3/4 of their maximum load; initial run-in should be at variable speeds.

After this initial run-in, the engines can be gradually brought up to full output. Before starting the propulsion engines, always check that the sea water intake valves of the cooling system are completely open.

Also check that following levels are correct:

- Coolant level;
- Engine oil level;
- Fuel quantity necessary for navigation.

If necessary, fill with coolant mixture, oil and fuel.

**CAUTION**

Use only technical fluids approved by the Manufacturer, following the instructions provided by the Manufacturer.

Engines must always be started with inverters in neutral position and throttle levers set to minimum speed.

Insert and check the correct operation of the following utilities:

- Starboard engine starter button;
- Port engine starter button;
- Air extractors in the engine room;
- Navigation lights;
- VHF.



**DANGER**

Before starting the engines, ensure that nobody is standing in the dangerous area.

**NOTE**

The start-up of the engine electronic system does not provide the actual insertion of the key into the slot, but it is only necessary to swipe the key (E-Key) on the engine ignition panel.

Carry out the following operations for each engine.

Set the gearbox to neutral position by using the throttles installed in the helm position.

- Sweep the E-Key in front of the panel and the ignition is on and the system unlocked.



- Press the START/STOP buttons to start the engine.



- Do not operate the starting engine for more than 10 consecutive seconds; if the engine has not started yet, release the push-button, wait for about 30 seconds and then operate the starting engine again.
- Once the first engine has been started, only after having verified its regular operation, start the second engine too, by following the same procedure described above.
- After engine start, verify that the oil pressure rises to normal values within 10 seconds. If low pressure condition persists, immediately stop the engines.



**CAUTION**

If you are forced to use battery parallel to start the engines, it is advisable to disconnect all unnecessary equipment to avoid voltage drops.

Long idle operation may cause cooling of the engine and subsequent bluish or white smoke. We therefore suggest avoiding long idle operation. The slow run implies major wear of the engine mechanical parts and is the most harmful from the point of view of polluting exhaust.

### 6.3.4 Check after engine start up

After correctly starting the engines, it is necessary to carry out some operational checks.

- Check that, within 10 seconds from engine start, the oil pressure values stabilise.
- Check that there is no anomalous noise or excessive fume from the exhaust; otherwise, turn OFF the engines and contact Riva After Sales & Service Department.
- Check that the alternators correctly recharge the batteries.
- Disconnect the 230V, shore cable, if still connected.
- Check for loose mooring ropes or floating objects hindering propeller movement.



#### **DANGER**

Make sure that no persons stand in front of gas exhausts and near the mooring ropes.

### 6.3.5 Engine drive

Despite the efficiency and high performance, particularly the sensitivity of the rudders, which allow for immediate response to the controls, the use of this yacht requires careful and responsible conduct.

#### **NOTE**

Even if the automatic pilot controls the route, navigation must be supervised in any case.

In the passage between displacement and gliding navigation there is a critical phase to be carried out as quickly as possible, as it is characterized by high consumption and more vibrations; it also causes a very deep wake. The minimum gliding speed is influenced by the displacement, the distribution of the weights on board, the position of the interceptor and the conditions of the sea.

#### **NOTE**

Set the speed of the yacht and the interceptor position according to the conditions of the sea and the prevalent direction of the waves; in this way the structure of the yacht does not undergo to useless stresses and the passengers can enjoy more comfort during navigation.

The excellent choice and quality of the engines allows keeping high speeds for a long time with no consequences.

Yet an excellent compromise between transfer speed, comfort and consumption is obtainable with about 1500/2000 rpm less than the maximum allowable revolutions.

Do not keep the propulsion engines at idle for a long time; in this way they do not become “dirty” or overheated.

Avoid harsh accelerations or decelerations to avoid excessive stresses for the engine turbines.

When the yacht reaches the cruising speed, the engine check instruments should set to constant values.

If the instruments show contrasting or abnormal indications during continuous running, check the systems and the equipment.

## 6.3.6 Stop of propulsion engines

Do not stop the engines immediately after a high-load operation, but let them run low (about 5 minutes) to balance the temperature differences.

The operations to be performed for engine stop are the following:

- Recall the throttles in central neutral position of the gear box;
- Press the STOP button;
- Cut OFF the magneto-thermal switches related to ignition of the two engines.



### **DANGER**

Make sure that the engines cannot be restarted by unauthorized staff.

### **NOTE**

With the engines stopped, carry out the following operations:

- Disconnect all unnecessary electric utilities and check the electrical panel as well as the indications of the voltmeters and ammeters.
- Check the switches of the bilge pumps and their correct operation.
- Close the fuel supply line.
- Turn OFF the sea water handwheel.
- Do the hour meter reading and perform preventive maintenance according to the maintenance schedule.
- Check for possible leaks.
- Rinse the yacht with fresh water.
- Connect the electric supply socket from shore.
- Keep the air extractors running until they automatically stop.

### 6.3.7 Emergency stop of propulsion engines

Because of a mechanical or electric fault, the normal and useful procedures for stopping the engines could not be sufficient; it is therefore necessary to stop the engines with the EMERGENCY procedures.

- STOP button on the helm position:  
On the control panel are placed the buttons “STOP” (1); Keep them pressed until the engine stops.
- Emergency STOP buttons in the engine room:  
Should it be not possible to stop the engines by means of the helm position buttons, use the “STOP” selector positioned above the engine (2).

**NOTE**

The emergency stop causes heavy stress to the engines with consequent hazard of component damage. Use the emergency stop only in case of real emergency.



**DANGER**

Before restarting the engines after an emergency stop, make sure to find and to clear the reason of the fault.



**CAUTION**

The engines emergency stop controls must be used only in case of real emergency. Never use these controls during the normal engine stop procedure.

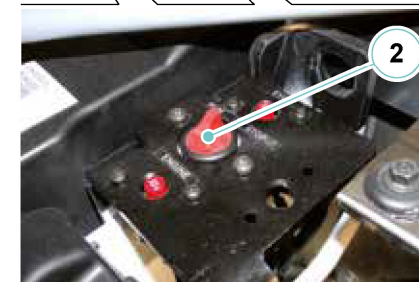
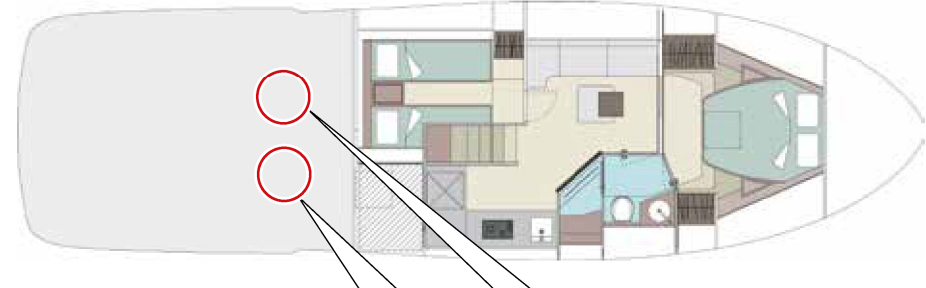
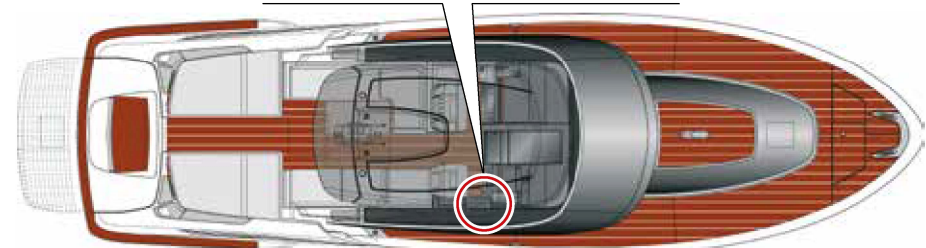

## 6.4 FIRST PERIOD OF USE

During the first period of yacht operation, in addition to the normal maintenance and check operations indicated in this manual, we recommend to carry out following additional operations and more accurate checks.

The duration of this period varies according to the frequency and use modes, such anyway to allow a correct run-in of all systems and components on-board.



### CAUTION

We recommend consulting the technical documentation provided by the Manufactures of the various on-board systems and components; they can indicate operations, checks and specific times not included in this section of the Owner's manual.

Following the first period of use, the hereunder listed additional operations and checks, should be performed at longer time intervals, playing anyway an important role for the safeguard and reliability of the yacht and navigation safety.

- It is recommended that new or overhauled engines should not be operated at higher loads than 75% of their maximum load and at variable speeds. After this initial run-in, the engine should be brought up to full output gradually.
- After starting each engine, check for the correct circulation of the cooling water inside the circuit, by verifying that it comes out of the drains. Check also for the presence of leaks from the sea cock valves and strainers of the cooling circuits.
- Before the engines start, check the correct tension of the V-belts.
- Check the possible presence of anomalous noises from the engines exhaust.

- Before and after navigation, check for possible leaks in the shaft lines.
- During navigation monitor constantly the temperatures and operation pressures of the devices on board (propulsion engines, generator, gear boxes).
- Check the proper recharging level of the engine and services starter batteries. Moreover, the engine alternators must correctly charge the batteries.
- Verify the rudders efficiency (by often checking the tiller angle) and interceptors.
- Before and after navigation, check the correct level of oil in hydraulic gangway.
- After the generator start, wait several minutes before loading it. Bring it slowly to maximum performance monitoring its correct operation.
- Check the correct load level of all extinguishers (fixed and portable ones) installed on board; the indicator needle on the pressure gauge should be set in the green range.
- Check on the indicator of main pressure gauge, possible pressure drops inside the system.
- Check before and after navigation the correct operation of all bilge pumps on board.
- Check tightness and closure of portholes and hatches.



### DANGER

Before performing the listed checks and maintenance operations, we recommend to read careful the Safety Rules relevant to maintenance, contained in this Manual.

**CAUTION**

Should more or less serious faults be noticed, contact the RIVA After Sales & Service Department as soon as possible.

**NOTE**

RIVA declines all responsibility concerning tampering carried out by third parties on equipment installed in the Shipyard. Such tampering or unauthorized installations will not only immediately void the warranty, but may cause damage to the yacht and injuries to the people on board.

RIVA declines all responsibility concerning periodical maintenance activities scheduled by the Shipyard or by Manufacturers, but not carried out, on equipment/components, for which it is necessary to refer to their own Technical Manuals.

## 6.5 REPLENISHMENT

### 6.5.1 Refuelling

Once the necessary fuel quantity to be filled has been determined, it is necessary to carry out a series of actions which will result in a safe and reliable refuelling.

First of all, stop engines and the generator.

Have to clear and ready for operation the area around the fuel tank, where the tank cut-OFF valves are installed for precautional purposes.

Another simple yet important operation is to close, as far as possible, all openings towards the outside of the yacht (e.g. access doors, windows, portholes, etc..) near the fuel tank vents, in order to minimize the penetration of diesel vapours and odours into the rooms.

At the same time, in case there are passengers on board, it is necessary to forbid access to the area around the filling inlet and the air vents, and to provide a fire extinguisher and hydrocarbon absorbing material near them.

Before refuelling, it is advisable to wet with water the teak in the area near the fuel filler neck. Once the filling inlet has been opened, it is possible to fill the tank.

The filling nozzle **(1)** is positioned on the starboard side.

Check that the filling pump is of suitable dimensions, and then insert it keeping it firmly.

While refuelling, monitor the vents, in order to check for accidental fuel spillages due to the formation of air pockets and foam. In the final phase of refuelling (at about two thirds of capacity), it is advisable to carry out frequent stops to allow foam to dissolve.

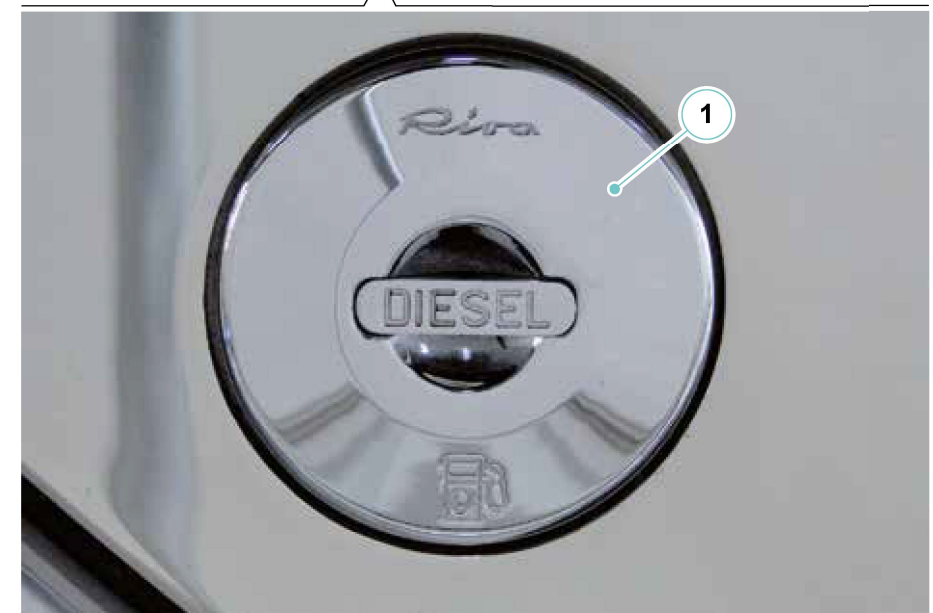
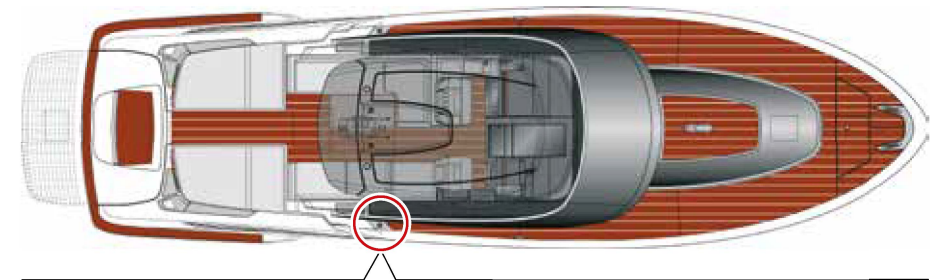

**ENVIRONMENT**

Do not disperse fuel in the environment in order to prevent pollution. Dispose of fuel-contaminated polluting waste according to the rules in force.

**CAUTION**

The inlet plug carry the indication "DIESEL" to avoid accidental input of different liquids. To avoid damage to the system and tanks, we recommend replenishing by gravity and not by pressure.

**CAUTION**

Refuelling should be performed at the end of navigation, in order to allow fuel cooling down, without condense. Drain the tanks, every 2 or 3 refuelling. Before refuelling, wash the teak with fresh water to avoid its contamination with fuel.

**CAUTION**

For the type of fuel to be used, follow the manufacturer's recommendations. Diesel engines require very clean fuel. Keep filters clean.

**DANGER****Explosion/fire hazard**

- Stow flammable material in a safety-approved container. Never stow flammable material in non-vented areas.
- Check bilge and engine room for fumes.
- Keep the ventilation system free of obstructions. Never modify the ventilation system.
- Inspect the fuel system for leaks.

**DANGER****Explosion/fire/pollution hazard**

Fuel system connections that are too loose or too tight can leak, resulting in fuel spillage, environmental pollution and explosion/fire hazard.

Once refuelling has finished, tightly screw the refuelling plug and dry possible fuel drops with absorbing material.

**DANGER**

Fuel is flammable and explosive: do not approach with flames and do not smoke while refuelling.

Carry out refuelling with the engines shut OFF.

Failure to comply with these precautions may cause fires with hazard of serious damage to property and injury to persons.

### 6.5.2 Fresh water supply

To carry out fresh water supply, it is necessary to stop the engines and ensure proper mooring of the yacht.

Reach the filling nozzle (1) located on the port side and open the cap by unscrewing it.

During supply, pay special attention to avoid that any object falls into the filling opening.

When filling is finished, tightly screw the filling plug.



#### CAUTION

The inlet plug carries the indication "WATER" to avoid accidental input of different liquids.

To avoid damage to the system and tanks, we recommend replenishing by gravity and not by pressure.

We recommend taking care of the tank's hygiene, by pouring a disinfectant solution every two fillings.

Avoid leaving the tanks full of water in case of frosting risk.

Do not leave the yacht unattended while replenishing.

#### NOTE

Water and fuel filling plugs are tied to the structure by means of a steel wire, in order to prevent losing or dropping them accidentally into the sea.

#### NOTE

Before refilling the fresh water tank, check that the water supplied by the shore fresh water system is potable.

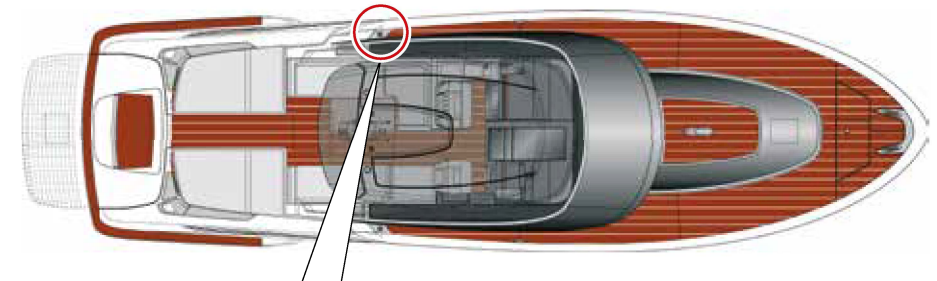

## 6.6 MOORING AND UNMOORING

### 6.6.1 Mooring operations



#### CAUTION

Before unmooring, make sure that all doors, hatches, portholes, etc.. are closed.

The ability to exploit such qualities depends on the “familiarity” the Captain has with his yacht. Practice is the only way to acquire confidence; with some exercise, in a short time, you will be able to safely perform mooring and unmooring manoeuvres even in very difficult or crowded areas or under unfavourable conditions.

A basic rule, that should always be applied, is to manoeuvre at low speed, in order to have enough time to react and to better evaluate the situation from time to time; thus, in case of unforeseen events, you will avoid damaging your or somebody else’s yacht.

Before unmooring, check the following:

- No other boats are manoeuvring nearby.
- The mooring ropes are not damaged.
- That the fenders are positioned and well fastened (in case of wind or surf, provide a passenger with fender to avoid damage).
- That there are no floating objects or loose ropes which can damage the propellers.
- The shore power supply cable has been well retrieved and stored on board.
- Drop the mooring rope from the stern, mooring on the dead body up to move away from the shore and manoeuvre for the exit.

If the mooring is on the side:

- Ease away the mooring rope from stern, warp on bow rope to move away the stern from the shore, manoeuvre for way out.

#### NOTE

Clove hitch:  
Is one of the most important hitches that anybody sailing at sea must know; it is the most useful hitch to fasten the fenders to the handles of the yacht.



#### NOTE

Cover the ropes of the fenders with leather in order to protect the fibreglass from possible rubbings.



#### CAUTION

Before starting the unmooring manoeuvres, disconnect the shore electric power supply cable.

#### NOTE

Before the unmooring operation, ensure that engines, gear boxes, rudders and bow/stern thrusters are in good working order. During such manoeuvres, the Captain should prevent any unpleasant noise, and/or wake that might bother other people.  
Before unmooring, make sure that all doors, hatches, port-holes, etc.. are closed.



**CAUTION**

Before starting the manoeuvre, make sure that the persons on board, especially if minors, do not hinder the operations and that they stop in areas where they can not cause physical damage.



**DANGER**

Check with extreme care that no one boarded is in danger (with legs or arms outside edge, in precarious balance or moving on wet or slippery surfaces) and that the fenders are well positioned and fastened.



**CAUTION**

Do not use the stern cleats as permanent mooring points of the yacht. They should only be used for the tender or jet-ski mooring. The stern cleats must never be used for the tender or chase boat towing.

1. Bow cleats
2. Mid yacht cleats
3. Stern winches
4. Stern cleats

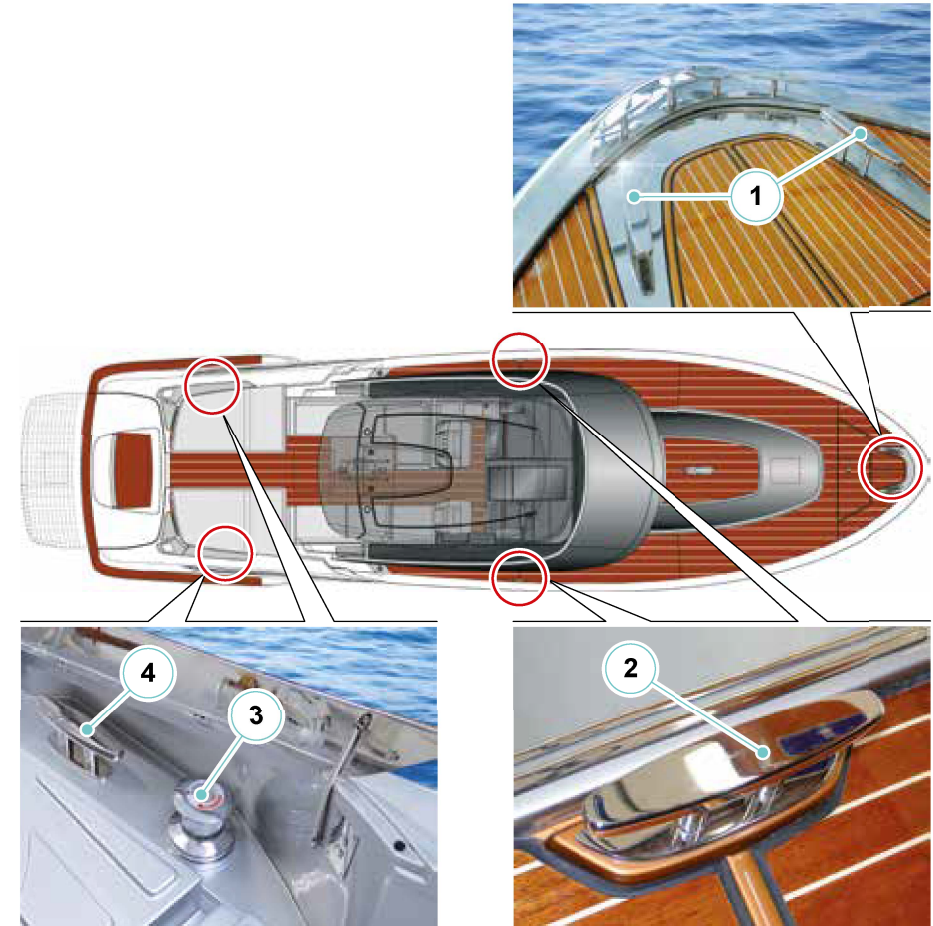

### 6.6.2 Leaving the mooring

The yacht is steered by means of the steering wheel, that operates the rudders (the rudder operation is independent from the engine operation).

In case of need and/or when in confined waters, manoeuvre the yacht by using the engines, changing the rpm or reversing their direction of rotation.

It is a good rule never to leave the steering wheel (the steering station), particularly when cruising at high speed or in confined waters.

Do not exceed the speed limits when operating in confined waters, harbours and wherever required.

Keep in mind that the rudders' effect is proportional to the propellers' rpm and to the yacht fresh way (especially with headway); as a result, with high rpm and high speed, the rudder response is high and quick, while when the engines are idling, with low fresh way, the reaction of the tiller angle is almost negligible.

### 6.6.3 Mooring operation

Before re-entering the harbour, check that:

- Mooring lines and fenders are ready for use and not hampering.
- The mooring points and the hauling course are free from approaching, mooring or departing boats.
- All utilities necessary for manoeuvring are supplied on the main electrical panel (anchor winch, bow thruster, etc..). Disconnect all not strictly necessary utilities.
- Position the interceptor in a completely retracted position.
- Just before reaching the harbour, stop in free waters and test reversing gears and bow thruster.
- The yachthook is easily accessible and does not hinder any passage.
- Acoustic alarm devices and the spotlight are working properly (in case of night mooring).
- In case of night mooring, have an operating torch light at hand.
- Bilge, grey water and holding tanks have been drained in the open sea.
- The passengers do not interfere with operations or, if participating, they know whom to listen to, what to do and where to go.

Proceed at reduced speed while approaching.

If the yacht is moored with the stern to the shore:

- Warp on stern ropes and on an anchor log, so as to haul the shore. Use the engines for short times, in order not to get strong headways or cause disturbance to other yachts already moored.

If the mooring is on the side:

- Warp on bow and stern ropes, so as to haul parallel to the shore.

Once moored:

- First take the measures listed in the description above, then stop the engines;
- Ensure that indication lights on the dashboard are OFF and remove start keys;
- Disconnect all unnecessary electric utilities and check the general status of the switchboard as well as the indications of voltmeters and ammeters;
- Check the status of the bilge pump switches and adjust their default operation;
- Stop the generator once the necessary cooling time has elapsed;
- Connect shore electric power supply;
- Wash the yacht with fresh water.

Before leaving the yacht unattended for a long time, check that:

- Lower deck lights are not powered;
- Navigation lights and external lights are not powered;
- The riding light is powered;
- The switches of unnecessary devices (plotter, radio, anchor winch, etc..) are not powered;
- Devices necessary for loading and unloading operations are powered;
- The shore plug is properly connected and the cable is free from any hindrances;
- Safety equipment (life jackets, yachthook, torches, etc..) have been stowed in their correct positions;
- On-board there are no bottles nor cases containing flammable liquids which are open or may fall/move;
- No food residues are left around (they could rot or clog scuppers, etc..);
- The gangway is in the right position and properly fastened;
- Mooring is correct (in case of bad weather conditions, tighten the mooring lines as much as possible and check that the distance from other yachts is appropriate; ensure fenders are properly fastened, etc..);
- Sea water intakes are closed;
- Portholes, internal doors and rooms lower deck and hatches in general are closed.

#### 6.6.4 Unattended mooring

If the yacht is left unattended, it is necessary to check that:

- The sea water inlets of the sea water circuits are closed;
- The condition of the main electrical panels is correct and disconnect all unnecessary utilities;
- In all rooms on board portholes, doors, windows and hatches are closed;
- Bilges are clean;
- Grey and black water tanks are empty;
- Fuel suction pipes are cut-OFF;
- The yacht is safely moored.



#### **DANGER**

The electric power supply from shore must be disconnected, especially if the yacht is left unguarded for a long period. Overboard outlets and drain pipes should be regularly checked, in order to ensure good buoyancy. The electric system should be regularly checked, in order to prevent fires on board.

## 6.7 ANCHORING

### 6.7.1 Anchoring operations

Anchoring and mooring operations are extremely important for the safety of your yacht; they therefore need experience and special care.

When you carry out anchoring and mooring operations it is good to remember that your yacht may suddenly change direction due to gusts and particular sea conditions, or passing of other yachts close to yours.

We remind you that the anchor system has no safety stop devices; therefore, when the anchor is near the hawse, or when you intend to release nearly the whole chain, it is advisable to control the last metres of chain directly from the bow, using the special push-button control.

In order to avoid overheating of the anchor windlass, it is advisable to help retrieval by moving, using the engines, the yacht slowly towards the chain, making sure that it does not damage the hull.



#### **DANGER**

Do not bring body parts or objects near the area where the chain or the lines are running. Make sure the electric engine is not supplied when acting manually on the anchor winch or when using the lever to release the clutch, as other people on board could operate the windlass from helm position.



#### **CAUTION**

Before activating the anchor windlass control, make sure the safety wire has been released.

#### **NOTE**

After each use of the push-button panel control, make sure that it is correctly stored in its place.

#### **NOTE**

Preferably operate the anchor windlass with the engines running to provide the high current required.

### 6.7.2 Anchor weighing

Start the yacht's engine. Make sure the clutch is engaged and pull out the lever. Press "UP" (1) on the push-button panel. Approach the anchoring point at low speed, in order to help the anchor windlass with its operation.

Never let the yacht being dragged by the anchor windlass towards the anchoring point. The chain's hoisting speed is proportional to the weight lifted. Release the "UP" push-button to stop the operation. Pay maximum attention to the last metres of chain, in order to avoid that the anchor damages the yacht's bow.

If the anchor is stranded and the magneto-thermal switch has tripped, wait for a few minutes before resetting it and try again.

If the magneto-thermal switch trips again, it is advisable to move the yacht to release the anchor.

Before going navigating, disconnect the anchor windlass power supply, lock it and mount the chain by means of the safety wire.

### 6.7.3 Anchor lowering

In order to drop the anchor manually, open the clutch and disconnect the safety wire. In this way, the wildcat will rotate freely around its own axis, dropping the chain into the sea.

Chain lowering may be stopped by rotating the emergency lever clockwise. At the end of the operation, close the clutch.

To cast the anchor electrically, press the "DOWN" button on the instrument panel.

During electric anchor dropping, the operation is perfectly controlled and can be interrupted at any time releasing the "DOWN" push-button.

Once anchored, it is extremely important to reduce the stress on the anchor windlass, locking the chain by means of the safety wire.

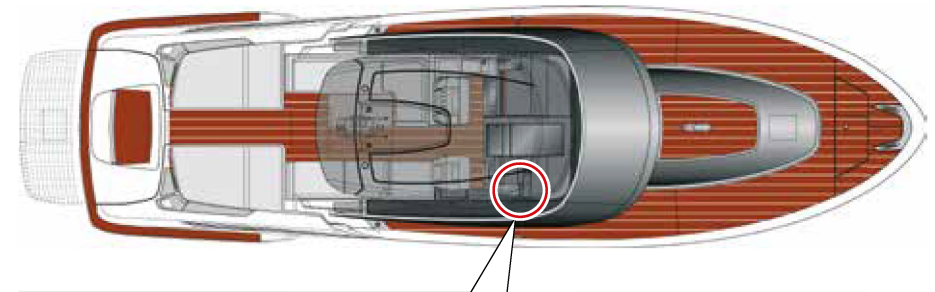

**DANGER**

Be very careful not to get too close to moving parts to avoid danger and injury.

**CAUTION**

NEVER navigate while the anchor chain has not been locked with the chain stopper and the safety wire

**CAUTION**

Anchor the ship with the engines running, both for safety reasons and to compensate the electric consumption of the anchor winch from the batteries. During anchor riding it is advisable to leave the anchor winch powered. The distance from obstacles or other yachts must be, at 360°, greater than the length of chain dropped. Do not suddenly reverse the anchor winch rotation.

**CAUTION**

In case of overnight anchor riding, ensure the correct operation of the white anchor riding light. Before dropping the anchor, check the nautical charts: anchoring is prohibited in certain areas; with weed-covered sea bottom, anchoring is unsafe and harmful to the environment; with rocky sea bottom, the anchor may get stranded or lost.

**CAUTION**

The anchor and the chain may damage the yacht bow if the anchor winch is not operated carefully.

We suggest carrying out the operation by means of the electric push-button panel located near the anchor winch; this shall allow checking the lifting and lowering speed of the chain and the entry and exit of the anchor shaft into the anchor roller.

During this operation, an excessive gliding of the chain or a wrong entry or exit of the anchor shaft into/from the roller may cause damage to the yacht's bow.

The anchor chain is fastened to the yacht by means of a line. In case you cannot remove the anchor from the bottom, by cutting the line you will be able to leave the chain and continue navigation.

The entire anchoring area must be free, in case of sudden variations of wind and/or current direction, especially in case of night anchoring.

**CAUTION**

We recommend to reduce load (chain and anchor) on the windlass, when riding at anchor.

You must use an appropriate size rope, fixed to the chain and then tensioned to a cleat.

## 6.8 SUGGESTIONS FOR NAVIGATION UNDER SPECIAL CONDITIONS

### 6.8.1 Navigation with bad weather conditions

Navigation safety depends mainly on the Owner's behaviour, who, according to sea conditions, shall either not set OFF or reduce the yacht's speed, sometimes considerably so as to face navigation at a more suitable pace.

It is very important during navigation with harsh weather, to make sure that all pieces of furniture, hatches, and mobile parts, are duly fastened or stowed, to avoid damages and above all to avoid hurting persons on board.

The reliability of the machinery, also due to a perfect maintenance, the scrupulous check during the pre-navigation phase and an Owner of proven experience assume, under adverse sea and weather conditions, an even greater importance.

For navigation at night, as it is to be considered as navigation in particular conditions, all recommendations and cautions mentioned above apply.

Navigation safety is furthermore supported by a range of factors, as:

- Proper bottom shapes;
- Main engine with suitable reserve power;
- Effectiveness of rudders and interceptors;
- High stability of the yacht;
- Well designed and carefully manufactured structures;
- Special care for the yacht trim in all load conditions;
- Easily reachable safety equipment;
- Suitable navigation instruments (autopilot, GPS, echosounder, etc..).



#### **DANGER**

Before undertaking navigation, it is necessary to know marine weather conditions which will be met on the route and at destination.

### 6.8.2 Significant speed - wave height table

The following table shows the maximum speed allowed in function of the wave height, in order to safeguard the yacht structural integrity.

#### **NOTE**

RIVA declines all responsibility for the improper use of the yacht, in relation to the wave height conditions.

Speed in knots	Significant wave height in metres
10	1,17
11	1,03
12	0,92
13	0,82
14	0,75
15	0,68
16	0,63
17	0,58
18	0,54
19	0,50
20	0,47
21	0,44
22	0,41
23	0,39
24	0,37
25	0,35
26	0,33
27	0,31
28	0,30
29	0,29
30	0,28
31	0,27
32	0,26
33	0,25
34	0,24
35	0,23
36	0,22
37	0,21
38	0,20
39	0,19
40	0,19

Beaufort Scale	Descriptive Term	Wind speed		Probable Wave height (Metres)	
		m/sec	knots	average	max
0	Calm	0 - 0,2	until 1	-	-
1	Light air	0,3 - 1,5	1 - 3	0,1	0,1
2	Light breeze	1,6 - 3,3	4 - 6	0,2	0,3
3	Gentle breeze	3,4 - 5,4	7 - 10	0,6	1,0
4	Moderate wind	5,5 - 7,9	11 - 16	1,0	1,5
5	Gentle wind	8,0 - 10,7	17 - 21	2,0	2,5
6	Fresh wind	10,8 - 13,8	22 - 27	3,0	4,0
7	Strong wind	13,9 - 17,1	28 - 33	4,0	5,5
8	Gale	17,2 - 20,7	34 - 40	5,5	7,5
9	Strong gale	20,8 - 24,4	41 - 47	7,0	10,0
10	Storm	24,5 - 28,4	48 - 55	9,0	12,5
11	Violent storm	28,5 - 32,6	56 - 63	11,5	16,0
12	Hurricane	over 32,7	over 64	14,0	-

### 6.8.3 The wind rose

It is particularly used in meteorology since it concisely represents the distribution of wind speed by direction in a particular place.

It is a polar graph in which the points are coloured with bands corresponding to the classes of wind speed for each direction.

The length of the points changes depending on the wind frequency in each direction.

The simplest wind rose is that with 4 points formed by only the four cardinal points:

- North (N 0°) from which the north wind blows;
- East (E 90°) from which the east wind blows;
- South (S 180°) from which the south wind blows;
- West (W 270°) from which the west wind blows.

Four intermediate points can be established between the four cardinal points:

- North-East (NE 45°), from which the north-east wind blows;
- South-East (SE 135°), from which the south-east wind blows;
- South-West (SW 225°), from which the south-west wind blows;
- North-West (NW 315°), from which the north-west wind blows.

Therefore by listing clockwise the eight principal winds are:

NORTH (N)	0°	Tramontana north wind	It is very intense and often in bursts, usually very cold or even frozen. Usually it anticipates dry weather and clear sky.
NORTH-EAST (NE)	45°	Grecale or Greco	It blows from the north-eastern Balkans area although the name indicates an origin further south "from Greece", due to the "Wind rose" position. As the Tramontana north wind, it blows in bursts. It is a cold wind and brings dry weather.
EAST (E)	90°	Levante east wind	Its name indicates "where the sun rises" direction. It is rather weak and simply is an advance of the Scirocco and therefore an announcement of deteriorating weather.
SOUTH-EAST (SE)	135°	Scirocco south-east wind	The name indicated the Syria origin. It is a warm wind that creates rough seas and that it becomes very humid in the northern regions due to the passage on the Mediterranean sea. It indicates the arrival of disturbances.
SOUTH (S)	180°	Mezzogiorno or Ostro south wind	It is weak and on the Italian regions not very perceived except in the Adriatic sea.
SOUTH-WEST (SW)	225°	Libeccio south-west wind	The name indicated the Lybia origin. It born in a rapid way reaching also considerable force. It drops suddenly and usually remains a situation of good weather. When it blowing is annoying and dangerous for the navigation: causes a strong wave motion.
WEST (W)	270°	Ponente west wind	It indicates the sinking direction. It is more common in summer and usually blows in the afternoon. It indicates, however, good weather.
NORTH-WEST (NW)	315°	Maestrale north-west wind	The name refers to Rome, "Magistra" for the ancient people. It is a cold wind, stronger and more constant of the Tramontana. It sweeps away the clouds of disturbances and brings good weather, clear skies and dry weather.

These four winds combined with those coming from the four cardinal points form the wind rose to 8 points.

Among the eight points identified above can indicate other eight, intermediate between the earlier, resulting a wind rose to 16 points.

The new eight points are clockwise: north-north-east, east-north-east, east-south-east, south-south-east, south-south-west, west-south-west, west-north-west and north-north-west.

The maximum extension of the wind rose is divided into:

- Four quarters of  $90^\circ$ , which leads to a division into 4 points.
- Each quarter is divided into two winds of  $45^\circ$ , thus arriving at 8 points.
- Every wind is divided into two half winds from  $22^\circ 30'$ , thus reaching at 16 points.
- Each mean wind is divided into two fourths (or rhombs) from  $11^\circ 15'$ , thus reaching at 32 points.
- Every fourth is divided into two half fourths from  $5^\circ 37' 30''$ , thus reaching at 64 points.
- Every half fourth is divided into two fourths from  $2^\circ 48' 45''$ , thus reaching at 128 points.

In ancient times each compass had the image of a wind rose to 32 points on the background. The horizon was thus divided into thirty-second parts, which were called the fourth, they were used as the approximate unit during the approach manoeuvres (e.g. lay two fourths starboard). Due to the shape that is created in drawing them, they are also called rhombs.

Once in Italy, cartographic representations included a wind rose pointing to the cardinal points.

Today it is used to indicate the four cardinal directions and the component directions with (clockwise from North) : N, NE, E, SE, S, SW, W, NW, then with the terms Tr (tramontana north wind), G (greco north-east wind) + (a cross pointed to the east), S (scirocco south-east wind), O (ostro south wind), L (libeccio south-west wind), P (ponente west wind), M (maestro north-west wind).



**6.8.4 Wind classification**

All types of winds existing on our planet.

Class	Name	Features
<b>Constant</b> Winds that blow throughout the year, always in the same direction.	Trade winds	They blow in the areas between the equator and the tropics: from north-east to southwest in the southern hemisphere, they are generated in tropical anticyclonic areas converging towards the equatorial zones.
	Extratropicals	They blow in the equatorial zones where, due to the heating, masses of hot and humid air ascending are formed.
	Westerly winds	They blow between 35° and 60° in correspondence of the temperate zones: from the south-west to north-east in the northern hemisphere, from north-west to south-east in the southern hemisphere. They are regular winds of the temperate zone.
<b>Periodical winds</b> Winds that periodically reverses the direction; they may be seasonal period, as the monsoons and Etesian winds, or in daytime period day as the breezes.	Monsoons (from the Arab word mausim, meaning season)	They are wind systems characteristic of the Indian Ocean and China seas; they blow during the summer semester (April-October) from the ocean (anticyclone) to earth (India and Asia north-eastern, cyclonic areas); during the winter months from India to the ocean (East Africa).
	Etesian winds (from the Greek word étos, meaning year)	They blow during the summer, from the Aegean sea to Egypt, and in the opposite direction during the winter.
	Breezes	Moderate winds in daytime period. They are distinguished into sea and land breezes: blow throughout the day from sea to land and at night from land to sea, mountain and valley breezes: by day blow from the valley to the mountains and by night from the mountain to the valley; lake and shore breezes: they act as the previous.

Class	Name	Features
<b>Variable or Local winds</b> Winds that irregularly blow in the temperate zones every time that cyclonic or anticyclonic areas form.	Scirocco south-east wind (from the Arab word shulùq, meaning noon wind)	Warm wind that comes from the Sahara desert, proceeding from the south-west to north, becomes laden with moisture over the Mediterranean and reaches Europe humid and violent.
	Mistral (from ancient Provençal maestral)	Very cold wind that blows from the Central French Massif and reaches the maximum power in the Rhone valley.
	Fohn or west wind (from the Latin Favonius, favère, meaning to make grow)	Hot, dry wind that mainly blows in spring and autumn in the alpine valleys to Austria and Switzerland, and sometimes reaches the Po Valley.
	Ghibli (from the Arab word qibli, meaning southern wind)	Wind of the desert, very hot and filled with sand, which blows for about thirty days a year on the territories of Tunisia, Libya and Egypt.
	Khamsin (from the Arab word khamasin, 50)	Hot, dry wind that blows in the Nile Delta from April to June. Lasts 3 to 5 days.
	Harmattan (from the Sudanese word haameta'n)	Hot dry wind that blows very violent on the territories of West Africa. It coming from the north-west in winter and spring.
	Bora (from the Greek word boréas, north)	Cold and very violent wind that blows from the Illyrian mountains in the former Yugoslavia to the coasts of Istria and Dalmatia and also arrived in Trieste. It blows only in winter.
	Austro south wind (from the Latin auster, south wind)	Warm wind that blows from the south.
	Gregale north-east wind (from the late Latin Graecalis, of the Greeks)	Wind blowing from the north-east to south-west on the central and southern Mediterranean sea during the cold seasons.
	Maestrale north-west wind (from maestro as main)	North-west wind. It is one of the winds that predominate on the Mediterranean sea.
	Tramontana north wind (from Latin trans montanus, beyond the mountains)	Cold wind, sometimes violent, coming from the north in winter season and that can invest across the Italian peninsula.
Libeccio south-west wind (from Libycos, coming from Lybia)	Wind from the west or from south-west, it is violent in all seasons. It blows over Corsica and on Tyrrhenian Italy.	

Class	Name	Features
	Chinook (from the name of a Native American tribes of the north-west of the United States of America)	Hot, dry wind that blows from the north-west on the Rocky Mountains (USA) mainly in spring and autumn.
	Pampero (from pampas)	Cold and humid wind blowing from the west between July and September especially on the Rio de la Plata (Argentina).
Irregular or cyclonic winds.	Cyclones	They are defined irregular winds and are violently destructive with whirling motion; they take different names by town: Hurricanes in the Antilles and American coasts of the Atlantic, typhoons (from the Chinese t'ai fung, violent) in the Yellow Sea and the Philippines; Tornado (whirl, vortex) in the Great USA Plains and Australia.

### 6.8.5 Navigation with only one engine

Your yacht is driven by two powerful propulsion systems designed to operate together and at the same time. However, in case of failure of one of the propulsion systems, you may navigate with only one engine.

Therefore, we suggest you to:

- Shut OFF the failed propulsion engine.
- Adjust the position of the rudders in the opposite direction to the failed propulsion system: in case the steering wheels cannot contrast the asymmetric push of the operating system, lower the interceptor on the side of the failed system, and further reduce the speed.
- Head to the nearest landing at a reduced speed.
- Keep the yacht at a speed that allows the best manoeuvrability.

In case one engine stops due to a failure and the gear box is in idle position, during navigation constantly keep an eye on the oil temperature of the gear box connected with the failed system.

The propeller shaft continues rotating thanks to the water flow through the propeller; in this way, some parts of the reduction gear continue rotating.

Should the temperature excessively increase over 80°C (176°F), lock the propeller shaft by engaging the reduction gear: in this way, the resistance will be higher but, since the gear box is jammed, oil will not overheat.



#### **DANGER**

It is absolutely forbidden to perform reverse gear with one of the two engines stopped.

This operation is allowed only in case of life danger for the persons on board and for the safety of the yacht itself; however, the operating engine must run no faster than at 1000 rpm.



#### **CAUTION**

The yacht has been designed to navigate driven by two engines; please remember that it is possible to navigate with one engine only in case of emergency.

Go to the nearest harbour and alert the rescue team, if necessary.

### 6.8.6 Collision

In case of collision while navigating, it is advisable to proceed as follows:

- Check the people on board and make sure that no one is injured.
- Immediately start the bilge pump and, if necessary, start the manual bilge pump, in order to reduce water entrance.
- Check for possible damage to the yacht's structure and evaluate the extent of the leaks.
- Slow down or stop the yacht in order to reduce water infiltration, or maintain your speed if you can keep the leak above the waterline.

### 6.8.7 Stranding

Stranding can be avoided paying attention to signalling buoys; shallow water is indicated by breaker waves when passing above a sand bank.

If your yacht strands, the seriousness of the situation depends on the violence of the impact against the seabed, and if the yacht remains stranded.

In case of stranding:

- Check for possible damage to the hull, to the propulsion system and to the steering system of the yacht.
- Check for leaks. If you are bilging, trying to stop the water from entering the yacht has priority on getting the yacht afloat.
- Evaluate the sea depth around the yacht and the type of seabed (sand, mud, rocks, etc.). This will help decide how to move the yacht.
- Evaluate whether tide or stream may help get the yacht afloat or if they contribute to running the yacht more aground.

## 6.9 ENGINE EMERGENCY SUCTION FROM THE BILGE

In the engine room there is the bilge emergency draining system, which operates with shunters, which allow using the sea water pumps, driven by the propulsion engines as draining pumps. These are valves which, in normal position, ensure the sea water suction for engine cooling, through the sea cocks and the sea water strainers. In case of emergency, operate the handwheels of both valves, bringing them to the emergency position: the suction of the pumps, driven by the engines is then diverted directly to the bilge.

Should it be necessary to use this draining system, the bilge level must be checked continuously, because in case of complete drainage, the engines will be without coolant.



### CAUTION

In case of emergency it is possible to suck the water from the bilge through the sea water pumps of each engine.

1. Engine sea cocks
2. Bilge emergency suction cocks
3. Suction selection handwheel
4. Engine sea cock strainers



### CAUTION

When the bilge is empty, remember turning the valves back to sea water intake position, in order to avoid damaging the engines.

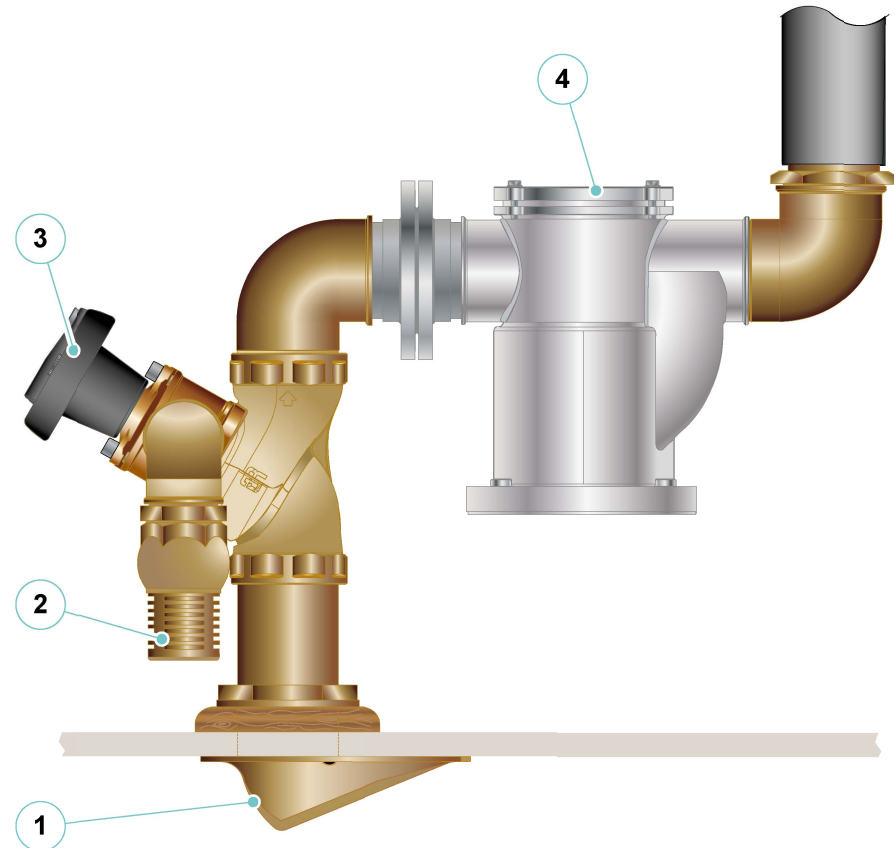

### 6.9.1 Operating diagram

All valves are provided in the sea-open position. Before proceeding with the installation, visually check the passage and that the wording through the handwheel window reads: **APERTO MARE / SEA-OPEN**.

The direction of the water flow through the valve must align with the arrow on each valve.

The handwheel is provided with a position indicator to simplify its use.

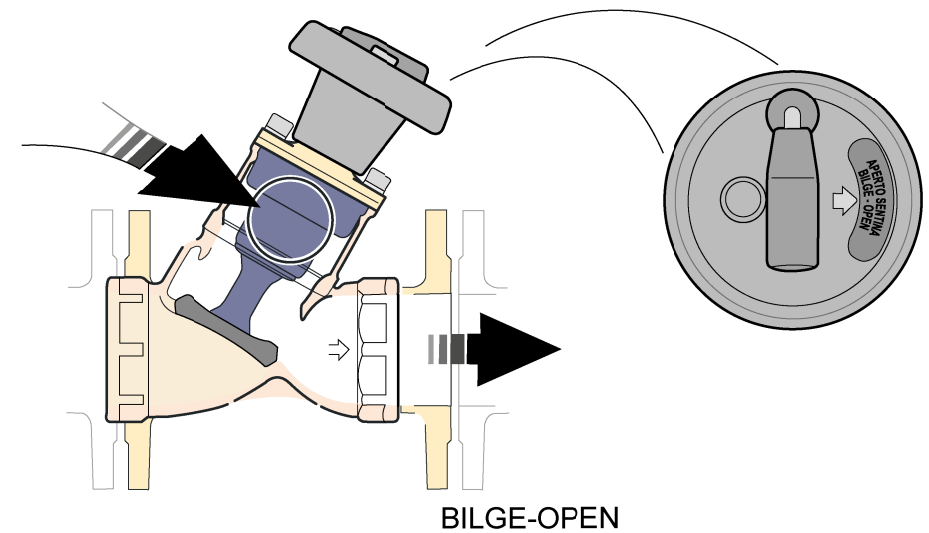
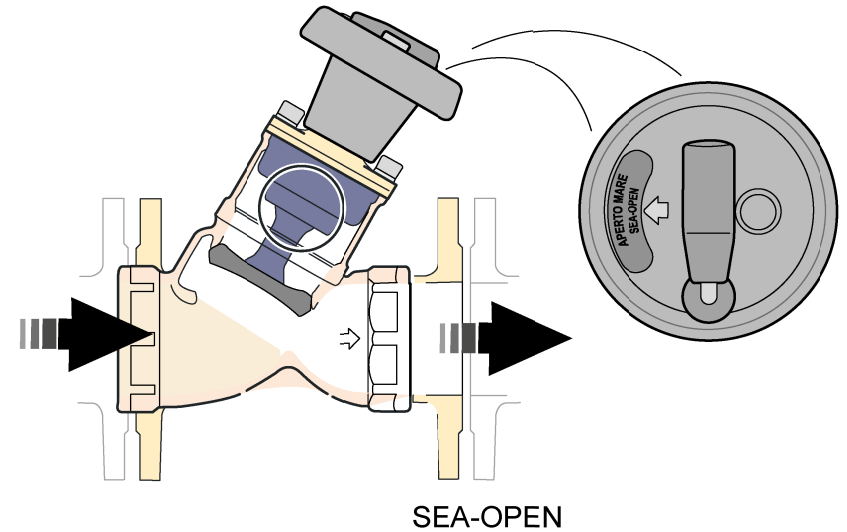

To enable water inlet from **SENTINA / BILGE**, proceed as follows:

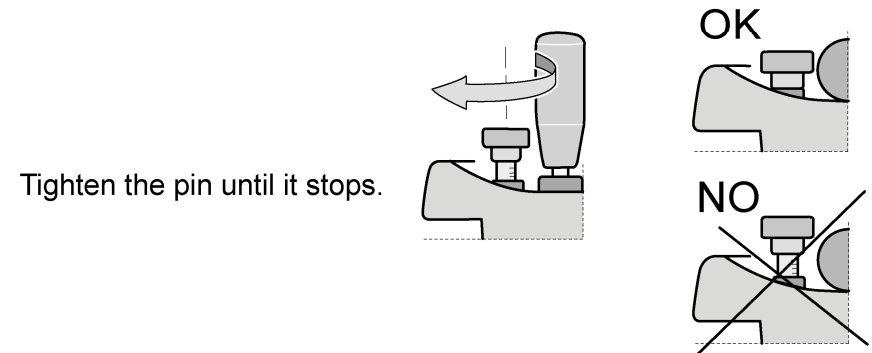
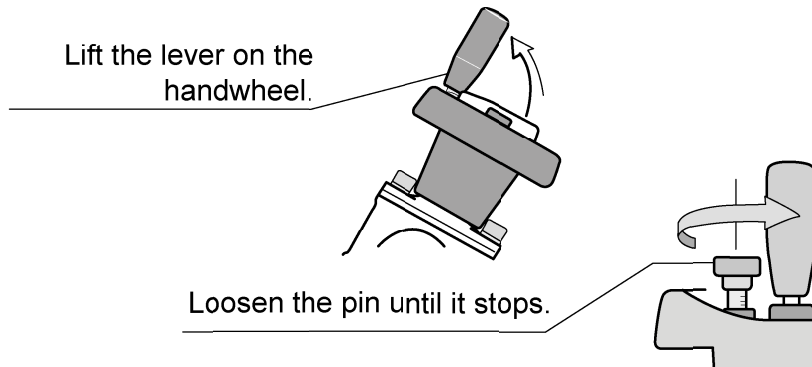

Turn the handwheel clockwise until it stops. In this phase the shutter, located in its housing, offers resistance. With both hands, close until it mechanically locks. The wording in the handwheel window will read: **APERTO SENTINA / BILGE-OPEN**, which indicates the inlet position.

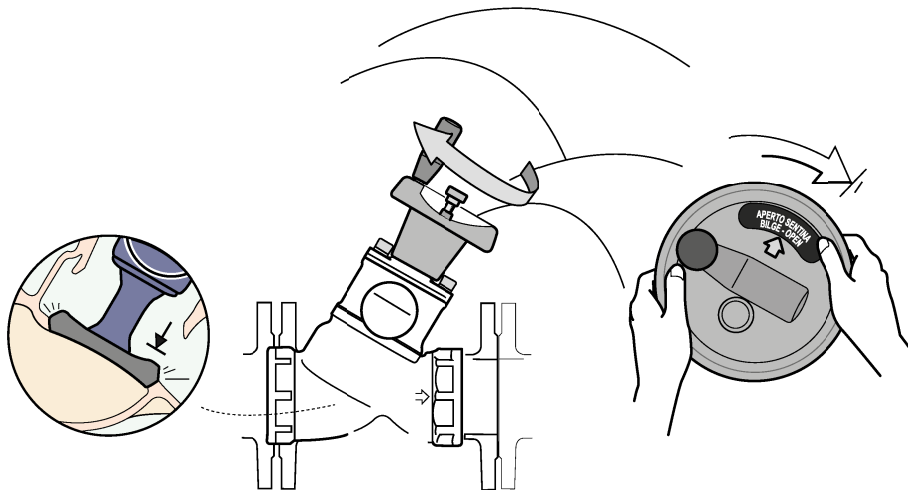

**CAUTION**

The pin is correctly tightened as shown. A complete closure of the pin has the purpose of preventing any movement of the shutter.

Lower the handwheel lever into its seat.

To enable water inlet from **SEA**, proceed as described above, turning the handwheel counterclockwise. Once the operation is finished, the wording in the handwheel window will read:

## APERTO MARE / SEA-OPEN

which indicates the inlet position.

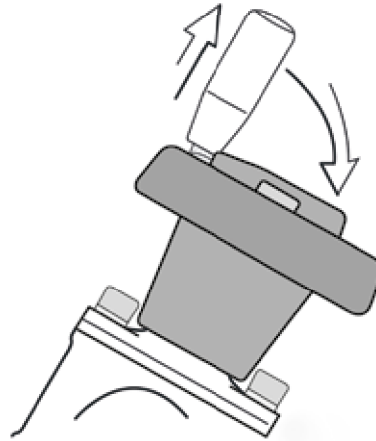

## 6.9.2 Maintenance

During ordinary maintenance, which must be carried out while the yacht is in dry shore, it is recommended to extract the valve control block as follows: make sure that the indicator is positioned to **SEA-OPEN** (first turn the handwheel counterclockwise). Loosen the screws with an Allen wrench and extract the mechanism from its body, paying special attention to the rubber components (gaskets).

### DO NOT remove the handwheel from its seat!

If necessary, clean the rubber components with fresh water and soap, do not use any chemical cleaners and pay attention not to damage the gaskets. If necessary, the control block can be replaced with a new one.

When reassembling, use silicone grease, and pay special attention to the seats of the gaskets.

Make sure to insert the mechanism in “**APERTO MARE - SEA OPEN**” position (first turn the handwheel counterclockwise as indicated in the INSTRUCTIONS).

Tighten the screws with a torque of approx. 9 Nm.

## 6.10 HAULAGE AND LAUNCH

Before the haulage and launching operations, check that no foreign materials are on board, that all items are properly rigged and that nobody is on board.

To position the bow band, it is necessary to check the load conditions because, according to the on-board load when lifting, remarkable movements of the centre of gravity are possible.

Check stability before lifting the yacht: the centre of gravity of the yacht depends on loads and their arrangement.

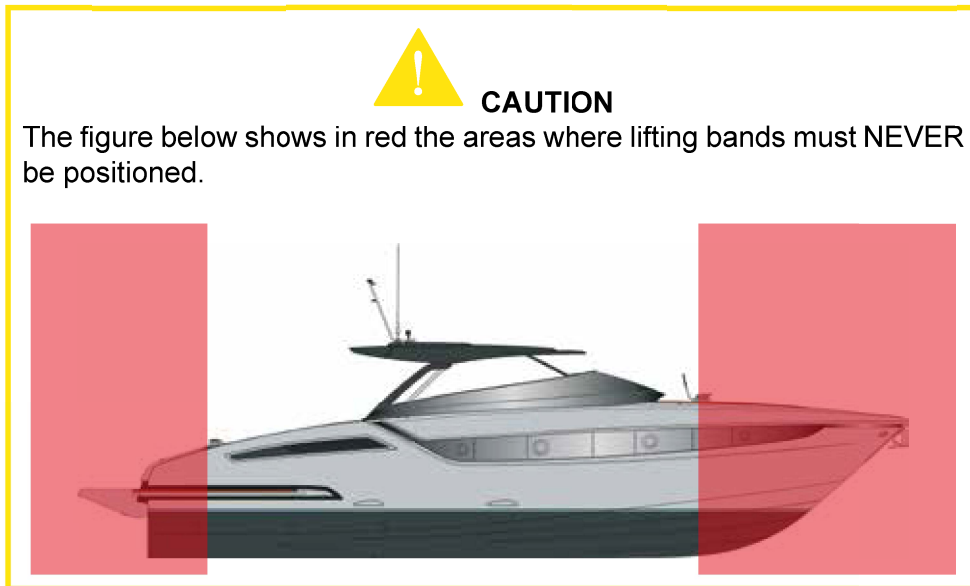

The lifting straps must not be worn out, and should be covered with suitable protections to preserve the bulwarks' gel-coat and the bottom hull antifouling paint.

The travel lift capacity must be greater than the yacht weight.

We recommend using a "spacer" to give the lifting straps an angle greater than hull width.

When ashore, the yacht must be placed on a cradle with at least five supports in the width and with a suitable size so as to evenly distribute the weight.

The hull inclination must be as "natural" as possible, e.g. it must be parallel to the waterline and not to the keel.

This to prevent that liquids on board keep a normal level and that rainwater can be drained naturally.

**DANGER**

During haulage and launch, never stay underneath or in proximity of the yacht.

**NOTE**

RIVA declines all responsibility for damage to property and harm to persons caused by the wrong performance of the hereunder listed operations. RIVA declines all responsibility for the location of the lifting straps, the lowering of the yacht to the ground and the support points carried out in other Shipyards.

**DANGER**

Hauling and launching operations must be carried out only by skilled personnel and in qualified Shipyards and under their direct responsibility.

**CAUTION**

In order to avoid damage to shafts and external appendices, it is essential to lift the yacht in the correct way.

Do not put the lifting straps at the intakes, sea exhausts or other protrusions. Lifting straps must be positioned according to the loading conditions of the yacht at the moment of its lifting, because these vary remarkably, for instance, when the yacht is unloaded and dry or when the yacht is fully loaded.

The bow strap arrangement must be carefully evaluated each time, in order to prevent any damage to the yacht.

## Cradles

RIVA is capable of providing the cradles for a correct support of the yacht (optional on demand). RIVA is not responsible for any damage resulting from the use of cradles different from those expressly produced by RIVA.

## Propping

It is a common procedure to use supporting props if no actual storage capacities are available. It is very important to take some basic precautions while positioning the supporting props for the yacht in order to prevent damaging the hull structures, accidental falls of the yacht or injury to the involved personnel.

The following list contains useful advice. We also recommend always having propping operations carried out by experienced personnel.

- Use props with adequate strength and stability (each keel prop must support at least 1/5 of the whole weight of the yacht).
- Use correctly dimensioned supporting plates to prevent negative weight concentrations.
- Place the props preferably next to transversal structural reinforcements (stringers).
- Locate the props along the supporting fins of the hull.
- Always place at least 5 props along the keel, 3 props starboard and 3 props port in order to guarantee stability and weight distribution.
- Start positioning the three keel supports along a straight line, appropriately spaced to distribute weight.
- It is important that the props have the same height in order to prevent that the load is concentrated mainly on one of them.
- Have the yacht lowered very slowly until it almost touches the keel props, adjust the height of the props until they are in contact with the keel, in order to guarantee a uniform load distribution and a neutral trim of the yacht; keep part of the weight supported by the crane.

- Position the adequately spaced lateral props; it is important to remember that the lateral props must guarantee stability, but the whole weight must be supported mainly by the keel props.
- Check the support for stability, then completely lower the yacht and remove the belts.

The suggestions above are to be considered as being generally valid for propping the yacht without damaging it or harming the personnel involved; however, since the propping conditions may significantly vary depending on the props used and the surface on which the props rest, the above suggestions must be adapted case by case.

RIVA is therefore not responsible for any damage to the yacht occurring while the yacht is at dry shore on props.



### CAUTION

RIVA declines any responsibility for the location of the lifting straps, the lowering of the yacht to the ground and the support points carried out in other Shipyards.

## 6.11 DRAWING AND TOWING

If, in case of emergency, you have to tow another yacht, we recommend passing a line between the fairleads of the stern cockpit, securing the two ends to the stern cleats.

The towing rope must be fastened in the middle of the rope in the bight with a "bowline" knot.

The length of the towing rope must vary according to sea conditions and to the mass of the yacht to be towed; anyway, the rope must not be shorter than three times the length of the yacht to be towed.

In case the yacht must be towed because it does not manage to navigate with its own means, direct a rope between the bow fairleads and fasten its two ends to the cleats.

The towing rope must be fastened in the middle of the rope in the bight with a "bowline" knot.

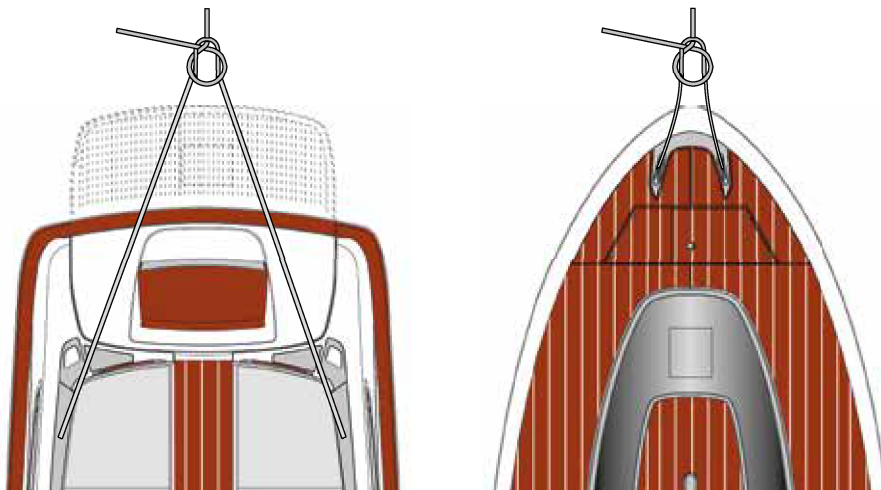

The length of the towing cable must be determined according to sea conditions; the cable must anyway not be shorter than three times the length of your yacht.

In case of emergency, if towing is not possible, give help by taking on board people from the other yacht, as many as possible, and reach the nearest harbour.

In any case, always immediately contact the Harbour Authority.

While towing, the water temperature and the oil pressure of the propulsion engines must be kept constantly under control.

While drawing, keep a speed suitable to the operation type.



### DANGER

Do not approach and do not carry out any kind of intervention on transmission during the towing because propeller can turn.

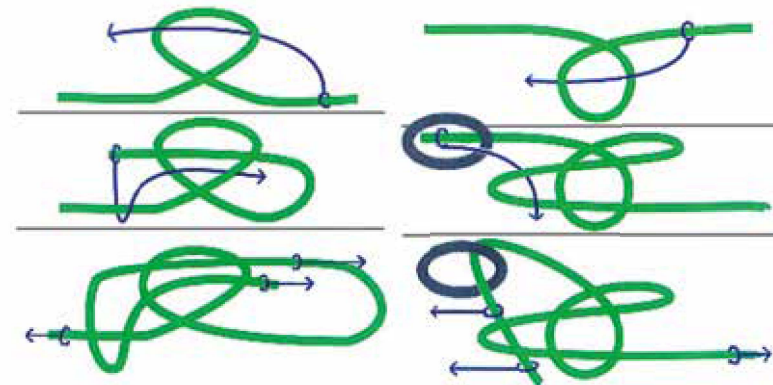

**CAUTION**

In case it is necessary to tow another yacht, do this under calm sea and calm wind conditions only, and tow yachts with a displacement not exceeding 50% of your yacht displacement; in case of emergency, if towing is not possible, give help by taking the people of the other yacht on board, as many as permitted and possible, and reach the nearest harbour. Anyway, inform immediately the Port Authority.

**CAUTION**

Towing navigation can be carried out continuously for 8 hours, provided that you constantly monitor the gear box oil temperature, which must not exceed 80°C.  
If temperature exceeds 80°C, stop navigation and wait until temperature lowers.  
When the engine is shut OFF, the throttle position is unimportant.

**CAUTION**

Do not stand near the ropes during drawing (or towing) operations, a rope that breaks can be extremely dangerous ("whip lash effect").

**CAUTION**

Tow or be towed always at low speed. Never exceed the yacht speed of a drive displacement when it is towed.

**CAUTION**

Ensuring a top of the trailer so that it can be cleared when it is under load.

**DANGER**

During towing navigation, the propeller shaft has to be kept turning by the water flow through propeller. We recommend not to carry out any kind of service on the thrust devices (engines, gear boxes, shafts, etc..).

## 6.12 GANGWAY

Your yacht is equipped with an electro-hydraulic aft gangway, for boarding the yacht from the shore. The electro-hydraulic unit controlling the oil flow which allows to move the gangway by means of the hydraulic cylinders is situated in engine room.



### DANGER

NEVER start navigation if the gangway is not correctly retracted.



### DANGER

The gangway, for boarding and leaving the yacht, shall be used only by one person at a time; make sure never to exceed the maximum capacity stated by the manufacturer.

Never operate the gangway when someone is passing on it; before activating it and during operation, make sure that no one is within its moving range.

When walking on the gangway, be cautious and keep hold to the handrail; as it is made of rope, it cannot be considered a rigid and safe support, but simply a help to keep balance.

### NOTE

The gangway can be operated only with the hatch fully opened or fully closed.



The movement is controlled by the dedicated panel installed astern the cockpit.

Each gangway is delivered with one remote-control units (Manufacturer advised you to required one as a reserve in case of loss).

The remote-control units are fragile electronic devices that must be kept in a dry place.

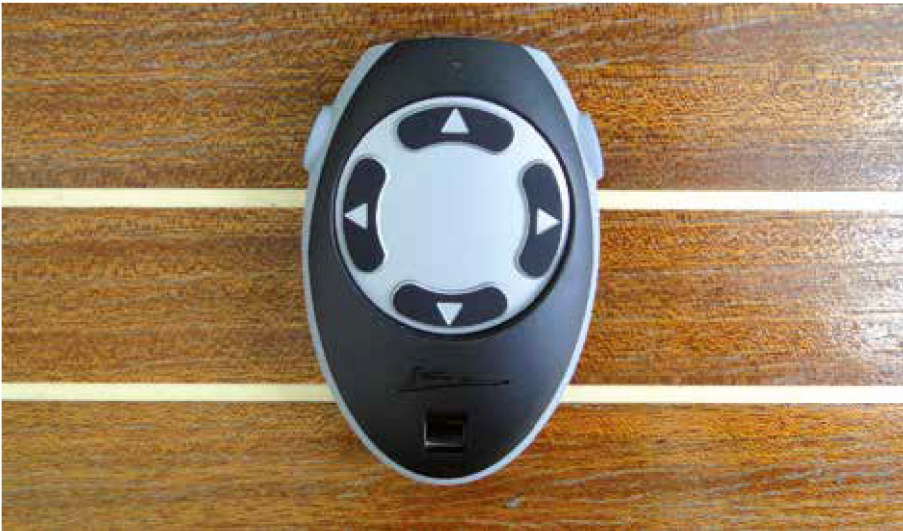

### CAUTION

The hydraulic gangway, even if easy manoeuvrable, might damage people and things.

Its use is recommended only to well experienced people.

### NOTE

The remote controls are supplied as standard and have an operating range of about 10 m (32,8 ft).

**6.12.1 Manual operation of the oil control unit**

**NOTE**

Position the gangway in such a way that it cannot touch the shore, either because of the normal yacht swinging or of the tide change.  
Should the gangway strike against the shore, it could get seriously damaged.

To carry out the gangway motion by means of manual pump, proceed as follows:

- Go to the end of the desired solenoid valve and press the cap.
- Press and hold and activate the manual pump of the oil control unit in order to allow oil flow.

By shifting to the different ends of the solenoid valves you can perform all gangway operations manually.



**CAUTION**

In MANUAL mode it is necessary to constantly monitor the position of the gangway during movement since the end of stroke sensors are cut out to collisions and resulting damage to the system or yacht.  
It is necessary to check that the gangway is properly aligned with its housing in order to retract it.



**DANGER**

All operations must be carried out under the supervision of the operator.



**CAUTION**

Always pay the utmost attention to the movements of the gangway; in case of emergency, press any button of the remote control or of the panel to stop the gangway.

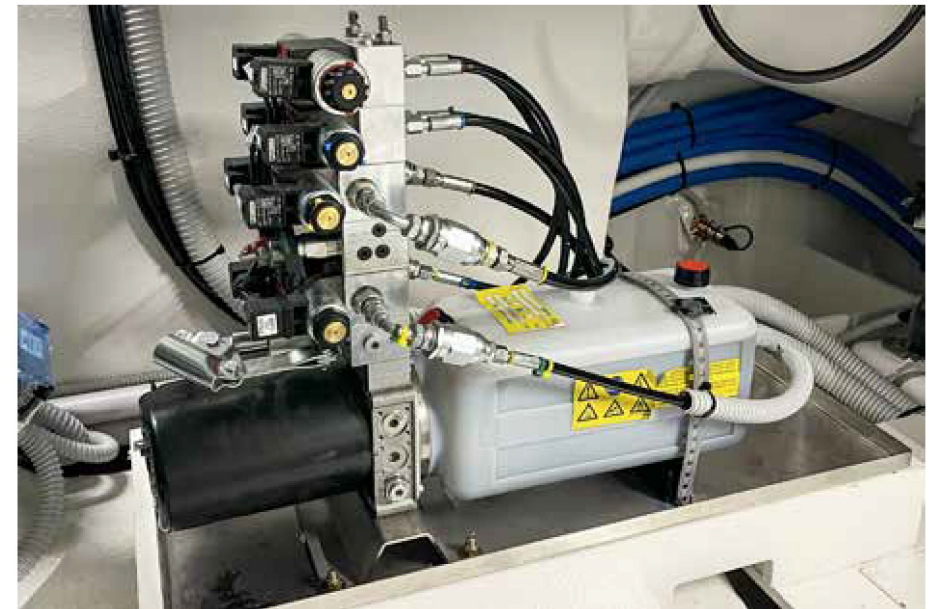



**CAUTION**

The hydraulic gangway, even if easy manoeuvrable, might damage people and things. Its use is recommended only to well experienced people.



**CAUTION**

Use and suggest to passengers comfortable shoes and eventually help them with the boarding.



**CAUTION**

RIVA declines all responsibility concerning tampering carried out by third parties on equipment installed in the Shipyard. Such tampering or unauthorized installations will not only immediately void the warranty, but may cause damage to the yacht and injuries to the people on board. RIVA declines all responsibility concerning periodical maintenance activities scheduled by the Shipyard or by Manufacturers, but not carried out, of equipment/components, for which it is necessary to refer to their own Technical Manuals.



**DANGER**

Never use the gangway to lift persons, even though the same is provided and tested to lift much heavier weights. Always make sure that the maximum load suggested by the Manufacturer is not exceeded. Never operate the gangway when someone is passing nearby. When walking on the gangway, be cautious and keep hold to the handrail; as it is made of rope, it cannot be considered a rigid and safe support, but simply a help to keep balance.



**CAUTION**

Do not use the gangway as a springboard.



**DANGER**

Never start navigation if the gangway is not correctly retracted. Make sure that the gangway, the swim platform hatch and the swim ladder are correctly closed, before undertaking the navigation.



**DANGER**

Pay attention to moving parts and to your hands.



**CAUTION**

Never use slippery products for the gangway cleaning.



**CAUTION**

Position the gangway in such a way that it cannot touch the shore, either because of the normal yacht swinging or of the tide change. Should the gangway strike against the shore, it could get seriously damaged.



**CAUTION**

RIVA declines all responsibility for any accident to persons or damage to property caused by a wrong use of the device.

**MAINTENANCE**

At least once a week carry out the washing with fresh water and an accurate cleaning.

At least once a month:

- Check the oil level in the control unit, when necessary top-up;
- Check the possible presence of oil leaks and bleeding;
- Check the operation of the emergency pump;
- Check the possible presence of corrosion;
- Grease the sliding tracks.

At least once every six months;

- Grease the swivel pins and the gliding sleeves;
- Tighten the locking bolts.

**NOTE**

The check and maintenance operations must be carried out by skilled technicians, instructed about the control unit operating conditions.

**NOTE**

The spares must correspond to the requirements established by the Manufacturer, this is obviously ensured with the use of original spares.



**CAUTION**

Always previously announce the gangway manoeuvring when there are people on the quay.

**NOTE**

Always manoeuvre maintaining eye contact with the gangway.



**CAUTION**

Never manoeuvre the gangway when people are present on the quay within range of the gangway.

**NOTE**

For further information on use and maintenance, please refer to the manufacturer's manual.

6.12.2 Gangway system maintenance

Component	Maintenance	Notes and precautions
Gangway	Oil top up	Check the oil level inside the tank every month and anyway before each navigation. Top up keeping the oil level at about three-quarters of the tank's capacity, and using the type of oil recommended by the Manufacturer.
	Cleaning	The gangway, being in contact with water and saline, needs careful cleaning.



**DANGER**

During cleaning or maintenance operations, make sure that nobody can activate the gangway, thus causing serious injury to persons, by cutting OFF power supply.



**ENVIRONMENT**

Do not discharge hydraulic oil in the sea, but in the special areas for toxic waste disposal.

**NOTE**

Improper use of the gangway, altering of the flow calibration, disrespect of manoeuvring procedures described in this manual relieves RIVA of all liability.

## 6.13 SWIM LADDER

The yacht is equipped with a swim ladder which allows easy access from the sea to the stern platform, and vice versa.

The swim ladder is placed inside the stern platform structure, in order not to cause obstruction during navigation.

It is manually operated:

- Turn the retaining pin **(1)** to release it;
- Pull the ladder from its seat.

The swim ladder does not require ordinary maintenance; anyway, being particularly exposed to sea corrosion, it is advisable to wash it accurately with fresh water after each use.

### 6.13.1 Inhibition sensor limit switch manual ladder and acoustic alarm

To extract the manual swim ladder located inside the stern hatch, the stern hatch must be opened.

When the swim ladder is removed, a position sensor prevents the closing of the stern hatch to avoid damaging the yacht.

In the case the sensor has a malfunction and inhibit the closure of the stern hatch, in the engine room has been installed a sensor by-pass command that allows to close the stern hatch after checking the effective closure of the swim ladder:

- A person must to monitor the progress of the movement to avoid possible interference between the swim ladder not completely closed and the closing seat of the aft hatch.
- The activation of the sensor by-pass command is signalled by an acoustic alarm which remains constantly active until the by-pass command is deactivated.



**DANGER**

Never use the swim ladder when the engines are running.  
 Pay utmost attention not to approach to the interceptors area, because they could be accidentally activated.  
 NEVER start navigation if the gangway is not correctly retracted.  
 With stationary yacht, it is compulsory to leave the swim ladder in the water, in order to allow a possible man overboard to board the yacht.

**DANGER**

Never access the stern platform during navigation, because it becomes a highly dangerous area.  
 Before operating the swim ladder, make sure that nobody is in its operation range.

**DANGER**

Risk of electric shock from leakage currents. Never swim in waters nearby harbours or marinas.

**DANGER**

Make sure that the swim ladder is correctly extracted and positioned before going down to water.

**NOTE**

Pay attention because the ladder can be slippery. Ensure a safe grip before climbing on board.

**CAUTION**

Do not use the swim ladder as a springboard.

**DANGER**

Pay attention to moving parts and to your hands.

**MAINTENANCE**

At least once a week carry out an accurate washing.

At least once a month:

- Check for corrosion signs;
- Grease the pulley gliding races of the steel cable;
- Tighten the locking bolts.

At least once every three months, grease the swivel pins and the sliding sleeves.

**NOTE**

RIVA declines all liability for any accident to persons or damage to property caused by a wrong use of the device.

## 6.14 YACHT STEERING RULES

### Ship in sight

We consider three ways of sighting of another yacht at sea:

- Encounter;
- Cross;
- Overtaking.

Generally, the yacht with limited ability to manoeuvre has the right of course.

We leave free the course and to pass it to stern. The yacht that has right of course is called privileged yacht. It can maintain its speed and course. The ship penalized is that must adjust their speed and/or course to maintain the due distance from the privileged ship.

### Encounter

When you meet another yacht that goes in the direction parallel, both yachts must adjust their speed and course.

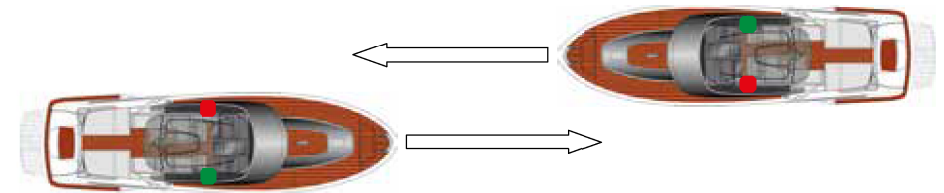

When two mechanical propulsion yachts are meeting on intersecting or nearly intersecting courses such as to give rise to the risk of collision, each one must change its course to starboard so that each one passes on the port of the other.

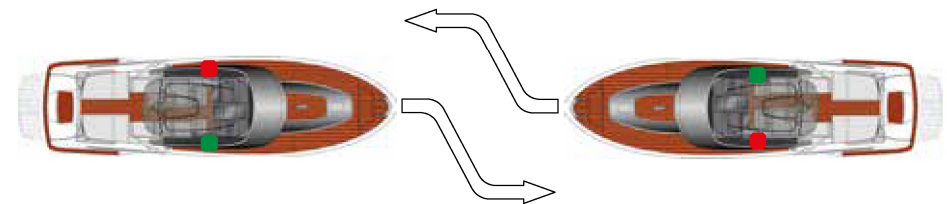

## Crossing

When two mechanical propulsion yachts are crossing, creating a risk of collision, the one that has the other yacht at its starboard must move away and, if the circumstances so permit, avoid passing on the bow of the other yacht.

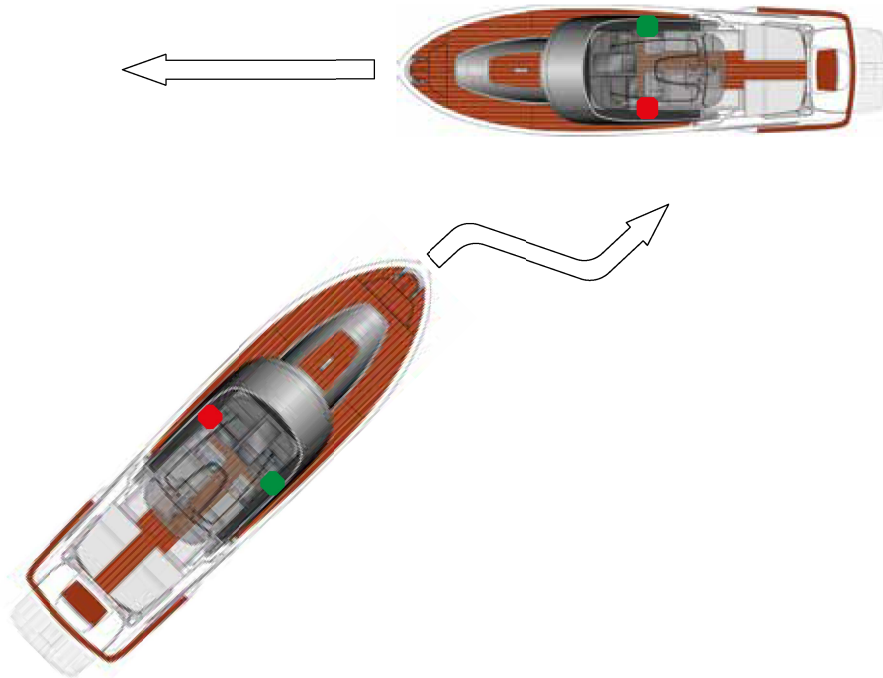

## Overtaking

Overtaking is defined as when a ship coming from a direction of more than 22.5 degrees at stern compared to the yacht that it plans to overtake, such that it can only see the light of the yacht stern but neither of the two side lights.

If you find yourself having to pass a yacht proceeding more slowly than you and that is on your course, your yacht is the one penalized. Make all the necessary adjustments to avoid the collision and pass to the bow or starboard.

Announce your intentions by sounding the horn twice if you intend to pass on the port, and one time if you intend to pass at starboard.

The yacht that is reached by another yacht takes precedence over the latter and therefore must maintain the same course and the same speed without laying or manoeuvring.

The yacht that has the bow within a 135° angle (formed by the yacht stern light) is considered the yacht that can be reached.

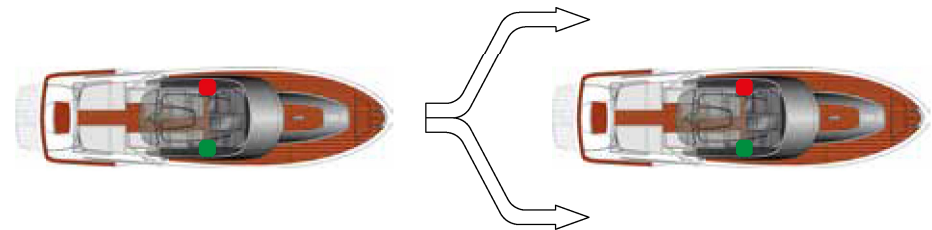

**CAUTION**

Having the right of course does not relieve you from the responsibility of avoiding a collision.

**Who exits from the harbor**

Has precedence over who enters and who passes in front of the harbor.

**Rivers and canals**

Who navigates with the current has precedence.

**Evasive manoeuvre**

The yacht that notices the other to its starboard and verifies that a risk exists manoeuvres in due time with a wide and easy to notice turn to starboard. In the case it cannot turn starboard, it reduces speed or stops the engines. When they are engine propulsion yachts, it must avoid turning to the port. The yacht with precedence maintains constant course and speeds. In the case the bearing changes appreciably, there is no collision course and the yachts maintain constant course and speeds.

**Evasive manoeuvre in the case the obliged yacht does not manoeuvre**

If the yacht that has precedence notices that the yacht obliged to give it precedence does not manoeuvre in reasonable time and spaces, at this point it has the duty to manoeuvre turning starboard until it makes a 360° turn, and then resumes its course.

The MINIMUM SAFETY DISTANCE from the other yacht to start the evasive manoeuvre depends on the yacht's displacement and ability to manoeuvre, the speed, visibility, traffic, weather conditions, and whether navigation is at night or in the daytime.

In any case it is a good rule to start the evasive manoeuvre well in advance, when the distance from the other yacht is still considerable, rather than waiting until it is too short.

**Responsibility between yachts**

It is necessary to observe the following regulations, except when in conflict with other rules:

Mechanical propulsion yachts navigating must leave the course free to:

- Yachts that are unable to steer.
- Yachts with limited ability to manoeuvre.
- Yachts busy with fishing.
- Sailing yachts.

Sailing yachts navigating must leave the course free to:

- Yachts that are unable to steer.
- Yachts with limited ability to manoeuvre.
- Yachts busy with fishing.

When navigating, yachts busy with fishing must, as far as possible, leave the course free to:

- Yachts that are unable to steer.
- Yachts with limited ability to manoeuvre.

**CAUTION**

Yachts with limited ability to manoeuvre usually have the right of course. In the event of an imminent collision, prudence has priority over right of course.

## 6.15 MAINTENANCE

### 6.15.1 General notes

The yacht is equipped with high quantity sophisticated devices and systems, which require not only a certain care of use, but also a periodical maintenance to obtain a correct operation.

One of the factors that might determine troubles or faults, is usually the irregular use of the yacht and as a consequence of this, of the on board devices.

The experience indicates that the regular use of the devices gives normally a less quantity of troubles, therefore, we recommend to have all on board devices regularly operate, for short periods.

Daily checks and periodical maintenance are important for maintaining equipment/components in the best efficiency conditions.

If the periodical maintenance schedule is not correctly followed, the equipment performance can decrease, causing an efficiency reduction, a shorter life and the occurring of unexpected problems which can compromise safety at sea.

The maintenance schedule is based on time or running hours intervals.

For example, if a maintenance task is scheduled every 100 hours or 3 months, such task must be repeated at 200 hours or after 6 months, at 300 hours or after 9 months, and so on.

In case of a long inactivity period (for example during winter) it is advisable to lay up the yacht, possibly under cover.

#### NOTE

Below is general information on the ordinary maintenance to be carried out, its frequency and the general procedures for its execution.

For further specific information on the maintenance programme, please refer to the Technical Manuals of the on-board equipment/components drawn up by the Manufacturers.

#### NOTE

Check periodically that all equipment containing water is filled with the correct quantity of anti-freeze.

If the outside temperature drops below 0°C, all fresh or sea water systems, are exposed to the risk of freezing and consequent breakage.

Systems especially subjected to risks of freezing are both the sea water systems (for instance the engine cooling system, the generator cooling system) and the fresh water systems (for instance the windscreen washer system, the fresh water pump, etc.), that is: all systems and devices containing either fresh or sea water.



#### CAUTION

Before carrying out any maintenance and adjustment operation on the yacht, turn all necessary safety devices on and consider informing all personnel, in particular persons operating nearby.

In particular, place warning signs in the concerned areas and prevent that any device, if operated, can cause unexpected hazardous conditions, thus endangering the persons on board and/or property.

Do not scatter any type of waste in the environment, to avoid pollution, and only use the dedicated disposal areas in the harbours.

**NOTE**

When working in the engine room, switch magneto-thermal switches of the bilge draining pumps off, to prevent that fuel, lubricants and other liquid spilling causes sea pollution.

**NOTE**

RIVA declines all responsibility for the installation and operation of electric, electronic or mechanical equipment improperly installed by third parties in a fashion not authorised by the Shipyard.

RIVA declines all responsibility concerning tampering carried out by third parties on equipment installed in the Shipyard. Such tampering or unauthorized installations will not only immediately void the warranty, but may cause damage to the yacht and injuries to the people on board.

RIVA declines all responsibility concerning periodical maintenance operations scheduled by the Shipyard or by Manufacturers, but not carried out, on equipment/components, for which it is necessary to refer to the relevant Technical Manuals.

## 6.16 LONG YACHT INACTIVITY

Following list only represents a general guide to give the customer an orientation on the ordinary maintenance which should be carried out when the yacht remains stationary for a rather long period without being used. We recommend carefully checking the instruction manuals of the single devices, because they often contain detailed information and very important specifications relevant to the maintenance of each device.

Following instruction NEVER REPLACE the specific instruction concerning each single device and issued by the device's Manufacturer.

- **Engines**

Before winter time, let fresh water flow into the sea water line, check the antifreeze liquid in the fresh water line and the protection sacrificial anodes against galvanic currents. Remove possible traces of salt and spray with protective sprays. Check oil and fuel filters and replace them if necessary. Carry out a maintenance schedule for the propulsion engines as indicated by the Use and Maintenance instruction delivered by the Engines Manufacturer.

- **Generator**

Use same procedure as for the engines.

- **Gear boxes**

Carry out maintenance schedule for gear boxes.

- **Batteries**

Check the liquid level and periodically charge the batteries, protect the terminals with vaseline grease; even better would be to disconnect the batteries from the system and to charge them periodically with a separate battery charger, but this is not always possible on yachts.

- **Sun-deck cushions**

Remove all sun-deck cushions and store them into a dry place.

- **Aluminium and steel**

Wash all metallic parts with fresh water and protect by rubbing with a rug soaked into Vaseline oil.

- **Wood and inner tapestry**

Cover the cushions of sofas with cloths and above all cover all windows with the relevant covering cloths, so that as less light as possible is projected inside, because the UV-rays fade the wood and tissue colours.

- **Mahogany wood deck**

Wash with water and neutral soap and treat with proper products. If strictly necessary sandpaper.



### CAUTION

DO NOT use for washing the main deck, mechanical means or the forced water jet (e.g: high pressure washers, etc..), as such a force alters the wood by caulking and sealants (highlights the microparticles) causing damage in some cases radial (e.g: separation of by concrete slats).



### CAUTION

DO NOT use for washing the main deck alkaline based detergents, acidic or with aggressive cleaning agents (soda, solvents, ammonia, etc..); their aggressive degreasing action erodes the wood (eliminates its natural water repellency, and it whitens its natural colour), while the sealant by caulking modifies the physical and chemical quality, making softer the part surface, damaging the waterproofing, sealing and the anchor of the main deck.

- **Sacrificial anodes**

Verify their wear and if necessary replace the hull, propellers shafts and interceptors, etc.. anodes.

- **LOG Transducer**

Pull out the propeller, clean it and apply the proper propeller plug.

- **Windscreen wiper**  
Wash with fresh water and lubricate them with Vaseline oil.
- **Anchor winch**  
Check the oil level in the gear box, where possible. Protect the electrical components with a suitable protective spray and lubricate with silicon grease clutches and wildcat.
- **Air conditioning**  
Before winter:  
- Let fresh water flow in the sea water system.  
After winter:  
- Check the anti-freeze mixture in the fresh water circuit: top-up or replace it if necessary (perform replacement at least every two seasons).  
- Carry out the maintenance operations suggested by the Manufacturer.
- **Grey water tank**  
Pour into the washbasin, showers and bidets drains sterilizing products. Empty the tank and clean verifying the floating efficiency.
- **Black water tank**  
Pour into the WCs a sanitary product containing Paraformaldehyde (available in the camping equipment shops) and rinse with this mix the tank for a couple of times. Drain the tank completely.
- **Thrusters (optional)**  
Protect the electrical components with a proper spray.
- **Electro-hydraulic control units**  
Protect with proper sprays and check the oil level.
- **Refrigerators**  
Cleaning and protection for the outer one, should the yacht remain in the open.
- **Fire extinguishers**  
Verify the loading condition and expiry date of periodical checks.
- **Safety equipment**  
Check the expiry dates of the self-inflatable means, flares etc..
- **Water tanks**  
Wash with disinfectant, drain the fresh water circuit, especially if frost is forecasted.
- **Fuel tank**  
Carry out cleaning by means of a decanter especially if there are traces of water into the fuel.
- **Engine room**  
As to the engine room, we suggest to carry out a general cleaning, by removing all traces of salt drifts on devices and protect all electric, mechanic and hydraulic devices, by spraying them with protective agents.

**6.16.1 General rules**

- Check all deck lights.
- Clean all cabins and inspect all dunnages on-board.
- Check all hatches seals and lubricate their contact with appropriate silicone lubricant.
- Clean fan coils with an air jet, sucking the dust from the back net.
- Inspect the outer hull and all components: propeller, anodes, shaft lines, struts, rudders, interceptors, fan coils, sea cocks, bow/stern thrusters.
- Carry out laying up of the yacht in a sheltered and dry place. If the yacht is stationed outside, cover it with a waterproof sheet, in such a way that allows ventilation. Otherwise the formation of damaging moisture could be helped.
- Wash the yacht with fresh water.
- Check all systems and fastenings on the yacht: damages, wear, cracks are signs of unsuitable use. Repair the damaged equipment. If necessary, fit new ones.
- Disconnect all unnecessary uses.

## 6.17 RE-USE OF THE YACHT AFTER LONG INACTIVITY

### Engines

- Check engine and gear box oil and change, if necessary. Check oil and fuel filters and replace them if necessary.
- Adjust the tension of the alternator belts both of the propulsion engines and of the generator.
- Fill the fuel tank. Vent the air of the fuel system.
- Start propulsion engines.

#### NOTE

After a long yacht inactivity, carry out all above-listed operations and following checks:

- Check the condition of all hoses and connections of the steering system, interceptor, gangway.
  - Start the engines.
  - Stop engines.
  - Clean fuel filters. Replace engine oil filters and add oil to the engines if necessary.
  - Check all bilge pumps and their operation.
  - Check the operation of the black water, grey water and sea water pumps.
  - Check the operation of all board instruments used for navigation.
- Let the engine run at middle speed for some minutes, before letting them run at full speed.

### Generator

- Start the engine of the power generator.

### Hull

- Check hull condition.
- Have the bottom hull accurately cleaned, as well as the rudders and interceptors with brushes (with water) or a jet-cleaner (dry) to remove seaweed and scales.
- Have the paint of the bottom hull checked. If necessary, have 2 coats of suitable antifouling paint applied by specialized personnel.

### Thrusters and anodes

- Verify the thrusters condition and possible leaks from the seals of the shaft lines, if necessary adjust them.
- Check the conditions of the sacrificial anodes; if necessary, replace them.

### Batteries

- Check the loading condition of the batteries, and that their terminals and housings are dry and clean.

6.18 HULL MAINTENANCE

Component	Maintenance	Notes and precautions
Bottom hull	<p>Periodical cleaning and check of antifouling treatment (as required according to stationary area, but at least every three months)</p> <p>Check/restoration</p> <p>Preparation of the surface of an already treated yacht</p> <p>Washing of the yacht</p>	<p>The length of the antifouling effects depends mainly on the conditions of the waters where the yacht is stationary.</p> <div data-bbox="857 408 2076 564" style="border: 1px solid black; padding: 5px;"> <p style="text-align: center;"><b>NOTE</b></p> <p>To remove the old antifouling, do not use sandblasting methods, as it may damage gelcoat surface and the anti-osmosis resin applied by the Manufacturer. As suggested by the antifouling manufacturers, use paint removers or, as an alternative, wet sanding.</p> </div> <p>The Shipyard uses high-quality ant-fouling paint and applies two layers.</p> <div data-bbox="857 647 2076 767" style="border: 1px solid black; padding: 5px;"> <p style="text-align: center;"><b>NOTE</b></p> <p>Bad maintenance condition (barnacles, etc..) may cause cavitation and damage shaft, rudders, propellers, etc..</p> </div> <div data-bbox="857 778 2076 863" style="border: 1px solid black; padding: 5px;"> <p style="text-align: center;"><b>NOTE</b></p> <p>Small areas of paint may peel OFF from the propellers even after a short period of operation.</p> </div> <p>Wash at each re-entering from navigation. Only use neutral and biodegradable products in case of dirt stains.</p>
External coated parts	Cleaning	<p>Do not use abrasive or cutting means. Wash at each re-entering from navigation.</p>
Exposed metallic parts	Cleaning	<p>Wash with fresh water and dry with moistened (wash leather) cloth. When re-entering from navigation, wash with plenty of fresh water, especially the handrail base, the windows, the skylights, etc..</p> <div data-bbox="857 1206 2076 1439" style="border: 2px solid yellow; padding: 10px;"> <p style="text-align: center;"> <b>CAUTION</b></p> <p>Alto in presence of rusty stains, NEVER work on the metal parts with brushes or abrasive cloths. Such a treatment would scratch the surface, damage the polishing of metal parts and reduce their mechanical features.</p> </div>

**6.18.1 Hull**

**ANTIFOULING TREATMENT**

If scales build up on the hull, these cause a remarkable speed reduction and with time may damage the “gel coat”. When you choose an antifouling paint for your yacht, it is important that you find the proper product, suited for your yacht and for the waters in which you are going to navigate.

Contact RIVA After Sales & Service Department.

**CHECK/RESTORATION**

The cleaning and checks have to be carried with yacht at dry shore or with the help of a diver.

Have the repairs done only with yacht at dry shore.



**CAUTION**

To clean and check the yacht in water: disconnect the engines and generator start.

**NOTE**

There are some hull areas (fastening area of thruster shaft support base, submerged drainage areas, areas around thruster tunnels and shaft exits, etc..) where operations can be carried out after hull pressing; in these areas, fillers are usually used which, over time, may produce local faults, like bubbles or small cracklings. These little faults do not impair the hull mechanical strength at all. To repair them just sandpaper the area, remove the bubbles, and apply fillings suitable for the bottom hull.

- Have the bottom hull accurately cleaned, as well as the rudders and interceptor with brushes (water) or a jet-cleaner (dry) to remove seaweed and scales.
- Let check the paint situation of the bottom hull. If necessary, have 2 coats of suitable antifouling paint applied by specialized personnel.

Preparation of the surface of an already treated yacht carefully check the old anti-fouling paint to see if it is still good or if it needs a new layer. Verify that the new product is compatible with the old one. Contact RIVA After Sales & Service Department. If the old antifouling is crusty, thick and tends to scale off, then remove it and start the treatment as for a new yacht.

**NOTE**

Antifouling is poisonous and should never be burnt, use only authorized disposal procedures and in case of doubts contact the authorities in charge. The sandblasting operations and removal of antifouling must be carried out with suitable clothes and protections.



**CAUTION**

During the application of antifouling, make sure that following parts of the bottom hull are not painted:

- Depth sounder transducer;
- LOG propeller;
- Sacrificial anodes;
- Shafts and thrusters.



6.19 GENERAL MAINTENANCE

Component	Maintenance	Notes and precautions
<p>Gel-coat</p> <div data-bbox="103 408 423 810" style="border: 1px solid black; padding: 5px;"> <p><b>NOTE</b> The alteration of colour and brightness in correspondence of areas which are highly exposed is considered as normal. The necessary polishing has to be considered as normal maintenance.</p> </div> <div data-bbox="103 826 423 1268" style="border: 1px solid black; padding: 5px;"> <p><b>NOTE</b> At least once a month perform an accurate cleaning of all fibreglass parts. At least once every six months check the status of the fibreglass. When necessary, but at least once every two years, polish all fibreglass parts.</p> </div>	<p>Formation of bubbles.</p> <p>Periodical cleaning (as required)</p> <hr/> <p>Formation of cracks.</p> <p>Periodical cleaning (as required)</p>	<p>In some areas of the yacht, bubbles may generate on the gel-coat; these bubbles can break over time, thus exposing the fibreglass underneath. The drawback occurs generally in vicinity sharp angles, and depends on air bubbles that, during fabrication, remain entrapped between fibreglass and gel-coat, although quality checks are carried out by specialised personnel. Broken gel-coat bubbles are easy to repair by filling the voids and touching up with gel-coat that can be requested to Riva After Sales &amp; Service Department.</p> <div data-bbox="857 587 2063 708" style="border: 1px solid black; padding: 5px;"> <p><b>NOTE</b> Always wash using neutral products. In case of particularly persistent dirt, do not use products containing ammonia that turn the surface yellowish.</p> </div> <p>When navigating, some structural parts of the yacht are subject to bending, and create tension or compression stresses in fibreglass and on the gel-coat; the different elasticity of gel-coat and fibreglass can cause small cracks on the gel-coat surface, in particular in the most stressed areas, e.g. near cleats, stanchions, etc.. This problem, however, does not jeopardize the mechanical and structural characteristics of fibreglass.</p> <div data-bbox="857 938 2063 1094" style="border: 1px solid black; padding: 5px;"> <p><b>NOTE</b> To remove possible gel-coat, do not use sandblasting methods that may damage the surface of the anti-osmosis resin applied and could expose fibres. As suggested by gelcoat Manufacturers, use suitable products or, as an alternative, wet sand.</p> </div>

Component	Maintenance	Notes and precautions
Wood and tapestry	Periodical cleaning (as required)	<p>Light and humidity are the worst enemies of these materials; do not expose them to direct light as often as possible, and ventilate the indoor spaces whenever allowed by the weather. It is extremely important the use of windows covers: any kind of wood, both natural and coated, will experience discolouring when exposed to sunlight.</p> <p>In spite of the painting cycles developed after so many years of experience, wood remains a "live" material and is therefore subject to movement and settlement.</p> <p>Scratches caused by bumps must be repaired immediately, to avoid the blackening of wood below. The technical staff of the RIVA After Sales &amp; Service Department will advise you about the maintenance level you have to apply at the end of each season of use. A correct maintenance will allow you to avoid deteriorations, repairable only at high costs.</p> <div data-bbox="913 644 2139 879" style="border: 1px solid black; padding: 5px; margin: 10px 0;"> <p style="text-align: center;"><b>NOTE</b></p> <p>The extremely precious finishing of the polish-varnished woods used for bathroom floors and cockpit tables is the result of an accurate work, it is water resistant but at the same time delicate and needing accurate maintenance. Such surfaces must therefore be dried after use (see bathrooms) or after the rain and a washing (see cockpit table), and a regular maintenance must be carried out.</p> </div> <div data-bbox="913 922 2139 1118" style="border: 1px solid black; padding: 5px; margin: 10px 0;"> <p style="text-align: center;"><b>NOTE</b></p> <p>Upholstering and wooden parts: the leather and wooden parts have to be treated as natural products, subjected only to colour alteration, particularly if the necessary precautions for a good maintenance are not taken. RIVA therefore reserves the right to evaluate troubles and its own responsibility each time.</p> </div>







Component	Maintenance	Notes and precautions
Mahogany	Periodical cleaning	<p>It is necessary to use fresh water and brush by hand (no hard bristles) at least once a day. This will eliminate any stains, common grime due to walking and the normal saltiness of the environment. If performed on a regular basis, this process keeps your mahogany and caulking constantly maintained. In this case only time and wear will deteriorate this product in a natural manner.</p> <div style="border: 2px solid yellow; padding: 10px; text-align: center;">  <p><b>CAUTION</b></p> <p>Washing the deck with mechanical equipment or with a jet of pressurised water (hydrocleaners, for example) IS STRONGLY ADVISED AGAINST since this force alters the wood and the caulking sealants (detaches the micro-particles), causing even radical damage in some cases.</p> <p>Washing the deck with alkaline or acid-based detergents, or however with aggressive agents (soda, solvents, ammonia, etc..) IS STRONGLY ADVISED AGAINST. Their aggressive degreasing action corrodes the wood (eliminates its natural water-repellent properties and bleaches its natural colour), while the physical-chemical properties of the caulking sealant are altered, with its surface portion becoming softened and the impermeability, sealing and anchorage of the deck becoming damaged.</p> </div>
	Clean and protect	<p>In spring, only when strictly necessary, sand.                      Wash with fresh water and neutral soap (like Marseille soap).                      Daily wash with fresh water.                      Do not use solvents or products that contain: acids, ammonia, alcohol, etc..                      Sand only when strictly necessary.</p>

Component	Maintenance	Notes and precautions
Mahogany	Periodical cleaning	<div style="border: 2px solid yellow; padding: 10px; margin-bottom: 10px;">  <p><b>CAUTION</b></p> <p>Be careful when cleaning the external painted parts. The use of alkaline or acid-based soaps or detergents that are normally used for removing grime or salt from bulkheads, cabin. So when these washings are used, it is necessary to isolate the teak and sealant mentioned from any deposits, even temporary, of soaps and/or detergents. If it is impossible to cover the deck while cleaning the GRP, we recommend you dampen it with lots of fresh water so that any accumulation of detergent slides away and off the deck. The same procedure is recommended when refuelling; if it is impossible to cover the deck, always dampen it with plenty of fresh water before each refuelling. If the fuel penetrates the wood or caulking sealant, the deck will be irreparably damaged. Use a neutral detergent for cleaning teak. If some or all the external wooden parts have been painted or soaked with copal, linseed oil, teak oil, etc., it is necessary to carefully follow the instructions provided by the manufacturer for daily cleaning operations.</p> </div> <p>Non-black caulking could have not the same behaviour compared with the black one, Any aesthetic issues like mildew on the surface, color variation, dirt in the caulking have not been addressed as defects and could be prevented with a regular maintenance and service of the mahogany surface and caulking.</p>
Painted Mahogany	Cleaning and preserving	<p>Wash with fresh water and neutral products. Dry with a soft cloth. Do not cause scratches.</p> <div style="border: 2px solid yellow; padding: 10px; margin-top: 10px;">  <p><b>CAUTION</b></p> <p>The extremely valuable finishing of our shiny coated wood, which is the result of an accurate manufacture of different layers, is water resistant, but is also delicate and needs special care. These surfaces must therefore be dried after use and need a regular accurate maintenance.</p> </div>

Component	Maintenance	Notes and precautions
Upholstering and wooden parts	Cleaning and preserving	Consider that leather or wood are natural products, subject to chromatic variations, especially if the necessary precautions for a good maintenance are not taken.
Auxiliary deck equipment	Cleaning and preserving	Wash with fresh water and neutral products after each cruise.  Protect against oxidation by cleaning the surfaces with a vaseline oil-moistened cloth.
Light alloys and stainless steel	Periodical cleaning (as required)	<p>It is a good rule to accurately wash the entire yacht after each navigation, in particular all metal parts that may be damaged by salty humidity. Have plenty of fresh water sprayed on handrail, windows, skylights, rub rail, anchors, cleats and ladder. Protect all metal parts with vaseline oil periodically.</p> <div data-bbox="913 624 2136 715" style="border: 1px solid black; padding: 5px; margin-bottom: 10px;"> <p style="text-align: center;"><b>NOTE</b></p> <p>At least once a year check the fastening of all metallic parts of the yacht.</p> </div> <div data-bbox="913 756 2136 879" style="border: 1px solid black; padding: 5px; margin-bottom: 10px;"> <p style="text-align: center;"><b>NOTE</b></p> <p>The tilting aft window is not watertight, so do not point the bolt of water towards the window, when washing.</p> </div> <div data-bbox="913 920 2136 1043" style="border: 1px solid black; padding: 5px;"> <p style="text-align: center;"><b>NOTE</b></p> <p>Never use brushes or abrasive rags on metallic fittings, not even on rusty spots, scratches on the surface result in a less shiny appearance and diminish the mechanical features.</p> </div>



Component	Maintenance	Notes and precautions
External cushions	General care and cleaning guide	<div style="border: 2px solid yellow; padding: 10px; text-align: center;">  <p><b>CAUTION</b></p> <p>Do not keep exposed to UV (solar light) for a long time without protections: when do not in use, take care to remove the cushions and stow them in a cover place or, if weather is good (not in raining days), you should cover the cushions to prevent deterioration.</p> </div>
Outer furniture and cushions	Cleaning and preserving	<p>Wash with fresh water at each re-entering from navigation, do not use hydro-cleaners, brushes or abrasive sponges. Let dry well in all its parts, especially the resting ones.</p> <p>Make sure the external coating is not deteriorated and that it does not absorb water.</p> <p>When possible, protect from direct exposure to the sun and/or to night humidity and/or weather.</p> <div style="border: 2px solid yellow; padding: 10px; text-align: center; margin-top: 20px;">  <p><b>CAUTION</b></p> <p>When not in use, remember to remove the sun-bathing cushions from their seats and to let them dry, so that no water or humidity remains between the cushions and the surface underneath. When washing the yacht or in case of rain, remove the cushions and stow them dry in a covered place. When possible, protect from direct exposure to the sun and/or to night humidity and/or weather. Make sure the external coating is not deteriorated and that the cushions do not absorb water.</p> </div>
Fenders	Periodic cleaning and checking	Keep all the fenders and the relative clean socks, washing them periodically with fresh water in order to avoid that the salt deposited on them scratch the paint of the hull.
Windscreen wiper and washer	Periodical cleaning (as required)	Wash them carefully with fresh water and coat with Vaseline oil; grease the spring with silicone grease. Check the rubber blades conditions periodically, and replace the blades if worn; this prevents bad visibility problems.

Component	Maintenance	Notes and precautions
Windscreen and deckhouse glass	Verification of sealings	<div style="border: 2px solid yellow; padding: 10px; text-align: center;">  <p><b>CAUTION</b></p> <p>At least once every six months, check the condition of the window seals. If you feel that the rubbers have deteriorated due to wear, please contact RIVA After Sales &amp; Service Department.</p> </div>
Windshield, windows and portholes	Cleaning	<p>Wash with fresh water, if necessary use neutral detergents.</p> <div style="border: 2px solid yellow; padding: 10px; text-align: center;">  <p><b>CAUTION</b></p> <p>Do not use rags or anything other than water: salt sediments or soil could damage the surface.</p> </div>



Component	Maintenance	Notes and precautions
Windscreen	Periodical cleaning	<div data-bbox="913 268 2134 419" style="border: 1px solid black; padding: 5px;"> <p style="text-align: center;"><b>NOTE</b></p> <p>Rags and doeskins used for cleaning the glasses must be replaces at least every 3 months. The inner side of glasses and windscreen can be carried out with a detergent for glass and a soft cloth.</p> </div> <div data-bbox="913 467 2134 619" style="border: 1px solid black; padding: 5px;"> <p style="text-align: center;"><b>NOTE</b></p> <p>If after normal cleaning some traces of dirt or light scratches remain, do not try and remove them with mechanical means or by means of aggressive detergents, solvents or abrasive products. Contact the RIVA After Sales &amp; Service Department.</p> </div> <div data-bbox="913 667 2134 962" style="border: 1px solid black; padding: 5px;"> <p style="text-align: center;"><b>NOTE</b></p> <p>Uniformly wet the whole surface of the glass with plenty of fresh water.</p> <ul style="list-style-type: none"> <li>• Use a neutral detergent or a delicate commercial product (not alkaline) diluted in fresh water.</li> <li>• Spread the solution with a soft and clean cloth. Frequently rinse the cloth in order to prevent deposits of dust or dirt particles which could scratch the glass or its glazed coating.</li> <li>• Rinse the soapy surface with plenty of fresh (or distilled) water.</li> <li>• We recommend drying the glass only with doeskin.</li> </ul> </div> <div data-bbox="913 1010 2134 1233" style="border: 2px solid yellow; padding: 5px;"> <p style="text-align: center;"> <b>CAUTION</b></p> <p>At least once every six months, check the condition of the window seals. If you feel that the rubbers have deteriorated due to wear, please contact RIVA After Sales &amp; Service Department.</p> </div>

Component	Maintenance	Notes and precautions
<p>Windscreen wipers and washers</p>	<p>Cleaning and preserving</p>	<p>Check the wear and preservation condition of the blades and replace, if necessary. A bad condition of the blades may lead to bad visibility in case of need.</p> <p>After each washing, spray some water from the nozzles to avoid the formation of limestone or salt stagnation.</p> <p>Wash the blades with fresh water and operate them on a weekly base. Grease the spring with silicone grease.</p> <div style="border: 2px solid yellow; padding: 10px; margin: 10px 0;"> <p style="text-align: center;"> <b>CAUTION</b></p> <p>In case of frost, lift the brushes from the windshield to prevent them from wearing. Always wash the windshield by means of the suitable nozzles or with water before operating the windshield wipers.</p> <p>During maintenance operations on windshield wiper blades, check that the windshield wipers cannot be accidentally operated.</p> </div>

Component	Maintenance	Notes and precautions
Instrumentation and navigation lights	Periodical cleaning (as required)	<p>Use clean wet rags for cleaning.</p> <div data-bbox="913 328 2136 555" style="border: 1px solid black; padding: 5px;"> <p style="text-align: center;"><b>NOTE</b></p> <p>At least once a week check the operation of the navigation lights.                      At least once a week, carry out an accurate cleaning of glasses and headlights.                      At least once every six months, check for the presence of corrosion in the cable connections of the navigation lights.                      At least once every six months, tighten the cable connections of the navigation lights.</p> </div> <div data-bbox="913 600 2136 826" style="border: 1px solid black; padding: 5px;"> <p style="text-align: center;"><b>NOTE</b></p> <p>At least once a week check the operation of the gauge cluster in the fly and of all instruments on board.                      At least once a week carry out cleaning.                      At least once every six months, protect the piston for fly gauge cluster opening with proper products.</p> </div> <div data-bbox="913 871 2136 960" style="border: 1px solid black; padding: 5px;"> <p style="text-align: center;"><b>NOTE</b></p> <p>Do not use chemical or abrasive products.</p> </div> <p>After navigation, cover instrumentation and equipment.</p>
Connectors and metallic components	Periodical cleaning (as required)	<p>Grease connectors and metal parts of the devices installed and exposed to moist and salty environment to prevent oxidation; pay particular care and attention to the above-mentioned components of the steering system, gangway, hatches and control units, etc..</p>

Component	Maintenance	Notes and precautions
Plexiglass	Periodical cleaning (as required)	<p>To clean the plexiglass use only products that do not contain aggressive substances such as alcohol, ammonia or the like.                      Preference for liquid detergent antistatic.                      Use cloth of soft material (such as cotton or felt).</p> <div style="border: 2px solid yellow; padding: 10px; text-align: center;">  <p><b>CAUTION</b></p> <p>Never use denaturised alcohol or acetone to clean plexiglas parts; they could crack inside.</p> </div> <p>To clean, to scour and to polish the plexiglass, spray a small amount of liquid detergent antistatic on the cloth and wipe the surface.                      The antistatic effect of the cleaner is very useful to prevent dust from being attracted by static electricity generated during the rubbing and that makes very difficult to clean the entire surface smoothly.                      If the cause of opacity is dirt, simply use an anti-static cleaning fluid and a soft cloth to remove smears: the plexiglass will clean and bright.                      If opacity is due to the contact with aggressive substances, it means that the surface has been compromised in the structure and the plexiglass can not return as before.                      If the marks are light and have been caused by wear and not from chemicals, anti-scratch dough can fix it.                      Even for light scratches anti-scratch dough is perfect. Do not ruin the surface and restores clarity to plexiglass.                      Anti-scratches dough removes surface scratches from normal wear.                      Those deep caused by sharp objects will not be eliminated but only mitigated.</p>
Light bodies	Periodical cleaning (as required)	Do not use alcoholic products to clean the light bodies.

Component	Maintenance	Notes and precautions
Ceilings Panels	Regularly check the planarity of the panels and / or any discontinuities or steps between the ceilings panels.	<p>Whenever the ceilings are dismantled, it is compulsory to check the status of the Fit Lock or/ and 3M Dual Lock fastening systems breakage of the teeth as i.e. and/ or the entire system.</p> <div style="border: 2px solid orange; padding: 10px; text-align: center;">  <p><b>WARNING</b></p> <p>Do not install ceilings panels with fastening systems damaged, Fit Lock or 3M Dual Lock, due of a possible reduction of their retention power. Damaged parts must be absolutely replaced with new ones.</p> </div> <p>In order to be sure that the ceilings have been reassembled correctly, check the planarity with the other ceilings panels and the absence of discontinuities and steps between one ceiling panel and the others.</p>

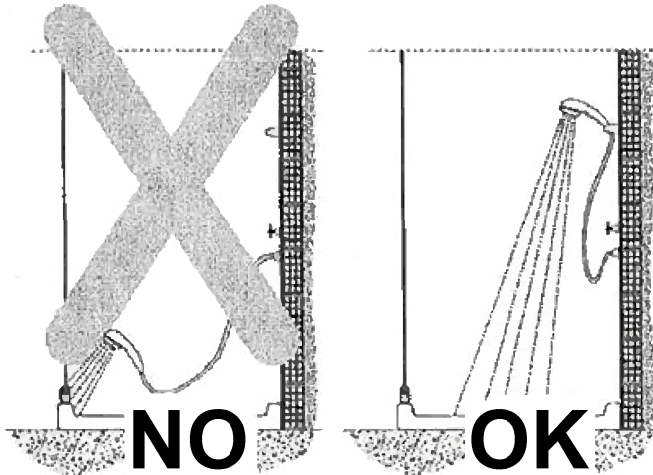
Component	Maintenance	Notes and precautions
Shower	Checking and replacing gaskets	<div data-bbox="857 263 2074 459" style="border: 1px solid yellow; padding: 10px;">  <p><b>CAUTION</b> Carry out periodic maintenance and/or replacement of the shower box seals, in order to prevent water leakage.</p> </div> <div data-bbox="857 499 2074 1375" style="border: 1px solid yellow; padding: 10px; margin-top: 10px;">  <p><b>CAUTION</b> The shower enclosures are made in such a way as to avoid water leaks outside the enclosure, under normal conditions of use of the shower. However, they do not have a watertight seal.</p> <div data-bbox="1137 759 1787 1235" style="text-align: center;">  </div> <p>The functionality of the shower cubicles is subject to the use for which it was designed; the water tightness is therefore conditioned by the correct use.</p> </div>

## 6.20 MAINTENANCE AND CARE OF VARNISHED WOODEN PARTS

Wood is a natural material, and for this reason, its aesthetic characteristics may change over time and depending on climate conditions (surface shrinkage, changes in colour and dimensions, etc..). The natural origin of this material means that each product possesses unique features that enhance its handcrafted character.

Caring for the wood on your boat is an act of love and respect for your vessel. From old panels that tell stories to new surfaces ready for future adventures, looking after the wood is key to maintaining the timeless elegance of our RIVA yachts.

Below are some essential tips that RIVA considers fundamental for the correct maintenance of your yachts.

To preserve the beauty of our yachts, whether dealing with aged wood or brand new surfaces, it's essential to adopt a dedicated care regime.

The maintenance of these parts includes cleaning, inspecting for hidden damage, sanding, and applying protective varnishes or oils. Regular check-ups are important to keep the wood in excellent condition and extend its lifespan.

Let's go through the key steps for caring for wooden surfaces:

- **Regular cleaning of surfaces.**

Regular cleaning is essential to maintain the wood's appearance. Use gentle detergents, preferably those specifically made for marine surfaces, to remove dirt, dust, and salt deposits that can damage the wood over time. Do not use pressure washers or high-pressure tools. Always wash with fresh water only, using a soft brush or scrubbing brush. Brush across the grain to avoid scoring the surface, then dry with a soft, dry cloth.

- **Inspection of the condition of the varnish and repair of damaged areas.**

Carefully inspect the wood for any signs of damage such as cracks, scratches, grooves, or mould. If the surface is still in good condition, a simple clean and possibly a light touch-up with a clear protective varnish will suffice.

If, on the other hand, the varnish is damaged or deteriorated, follow these steps:

1. Sanding: Use fine sandpaper to remove damaged areas and even out the surface;
2. Cleaning: After sanding, remove dust with a damp cloth or compressed air;
3. Varnish application: Varnishing is one of the most important steps in wood care. Apply even coats of high-quality marine varnish. Consider using polyurethane-based products for better durability and resistance to the elements, or choose exterior-grade varnish (e.g., water-based enamels or specific synthetic varnishes);
4. Clear coat application: After applying coloured or protective varnish (except on decks with maple inlays), apply a layer of clear coat. This layer serves to protect the underlying varnish from external elements such as moisture, UV rays, and temperature fluctuations, helping to prevent damage or fading. It also adds a glossy or satin finish to enhance the appearance.
5. Drying and curing: Allow each layer of varnish and clear coat to dry fully, according to the manufacturer's recommended times. Proper curing is crucial for achieving optimal hardness and long-lasting protection.

- **Inspection of the condition of silicone seals and repair of damaged areas.**

Deterioration of silicone (sealants) used on wooden parts of the boat can compromise the integrity of joints and cause water ingress, potentially damaging the wood. Here are some signs that indicate a deterioration of the silicone surface or sealed joints:

- Visible cracks or fissures;
- Warping or shrinkage;
- Colour no longer shiny and uniform but faded or opaque;
- Loss of elasticity;
- Accumulation of mould or algae;
- Water infiltration near sealed areas;
- Roughness or dustiness.

If one or more of these signs is present, remove the old silicone and replace it with a new layer of sealant. Ensure the surface is thoroughly cleaned before reapplying to guarantee good adhesion and prevent future leaks.

Timely replacement of silicone is important for maintaining the boat's integrity and protecting the wood from moisture damage.

- **Protection and Precautions**

- Remove dirt, algae and salt with fresh water and a soft brush to prevent damage and deterioration;
- Regularly inspect wooden surfaces to identify and address any problems promptly, preventing more serious damage from occurring;
- Check that the silicone seals are uniform and that there are no cracks or degradation on the surface or in the joints;
- Avoid prolonged exposure to standing water;
- During the winter period or when the boat is not in use, use protective covers to reduce the exposure of the wood to the elements and temperature changes.

Summary table of operations:

Operation	Frequency	Description
Regular cleaning of the wood surface	At each use	Remove dirt, algae and salt with fresh water and a soft brush to prevent damage and deterioration.
Check for cracks or deformations	Quarterly	Regularly inspect the wood for cracks or deformations that could compromise the safety or durability of the wood.
Inspection of the varnish and finish	Quarterly	Check for damage or wear to the varnish and finish. Sand and reapply varnish as needed.
Checking the condition of the silicone seals	Every six months	Check that the silicone seals are uniform and that there are no cracks or degradation on the surface or in the joints.

Any restoration work on the boat must be carried out exclusively by authorised RIVA After Sales & Service Department using trained personnel.

Following the above recommendations is essential for maintaining the basic condition of the vessel and for upholding the boat's warranty.

**6.21 SPEED MULTISENSOR MAINTENANCE (LOG SENSOR)**

Component	Maintenance	Notes and precautions
LOG - speed multi-sensor with valve	Periodical check ordinary Maintenance	<p>As indicated in the Manufacturer's Manual.</p> <div style="border: 1px solid black; padding: 5px; margin-top: 10px;"> <p style="text-align: center;"><b>NOTE</b></p> <p>At least once every six months check the correct operation.                      At least once every six months check the connection of the cables.                      At least once every six months check the propeller and grease the outer LOG.</p> </div>





## MANUAL ACCEPTANCE FORM

Dear Customer,

We have the pleasure to deliver to you the Owner's Manual of your 48 DOLCERIVA.

Hull no. 44; code IT-FERRDR44H526

This manual has been printed in two identical copies: one delivered to you and one kept at RIVA.

As a confirmation that you have read the whole manual, we kindly ask you to sign and send this page to the following address:

RIVA After Sales & Service Department  
Ferretti S.p.A.  
Via Ansaldo, 7  
47122 - Forlì (FC) - Italy  
Tel: + 39 0543 787511  
Fax: + 39 0543 473069  
customer.service@riva-yacht.com

## MANUAL ACCEPTANCE FORM

Dear Customer,

We have the pleasure to deliver to you the Owner's Manual of your 48 DOLCERIVA.

Hull no. 44; code IT-FERRDR44H526

This manual has been printed in two identical copies: one delivered to you and one kept at RIVA.

As a confirmation that you have read the whole manual, we kindly ask you to sign and send this page to the following address:

RIVA After Sales & Service Department  
Ferretti S.p.A.  
Via Ansaldo, 7  
47122 - Forlì (FC) - Italy  
Tel: + 39 0543 787511  
Fax: + 39 0543 473069  
customer.service@riva-yacht.com



Date:

(On behalf of) The Owner:

